



## MBM 128085

Article No. 0301102900

Material: Polycarbonate

Protection class: IP65

MBM Enclosures offer excellent properties for the installation of electronic and electrical components as well as complete control systems.

Thanks to the high UV-resistance of the material, these enclosures can be used in both indoor and outdoor areas.

The MBM Enclosures are mechanically processed in a number of ways providing almost no limits with customised surface design, including silk screen printing and membrane keyboards.

The enclosures are available with a grey or transparent cover (K).



We would be glad to assist you!

### MULTI-BOX GmbH

Wallücker Bahndamm 7  
D-32278 Kirchlegern  
Tel. +49 (0)5223 49107-0

info@multi-box.com  
www.multi-box.com



### Dimensions and weight

Length (mm)	120
Width (mm)	80
Height (mm)	85
Weight (g)	218

### Color information

Color description cover	Light grey
RAL-code cover	7035
Color description base	Light grey
RAL-code base	7035

### Technical Drawings

PDF	
DXF	
3D	



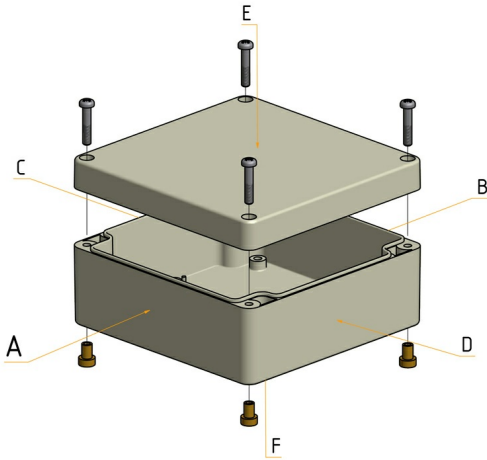

We would be glad to assist you!

**MULTI-BOX GmbH**

Wallücker Bahndamm 7  
D-32278 Kirchlengern  
Tel. +49 (0)5223 49107-0

info@multi-box.com  
www.multi-box.com

**Material information**

Material cover	Polycarbonate
Material base	Polycarbonate
Material sealing	Polyurethane
Material screws	Stainless Steel V2 A
Silicone-free	<input checked="" type="checkbox"/>
Halogen-free	<input checked="" type="checkbox"/>
Material UL listed	<input checked="" type="checkbox"/>
UV-resistant	<input checked="" type="checkbox"/>

**Temperature resistance and application areas**

Permanent operating temperature max. (°C)	100
Permanent operating temperature min. (°C)	-40
Suitable for outdoor use	<input checked="" type="checkbox"/>
Suitable for indoor use	<input checked="" type="checkbox"/>

**Technical specifications**

Protection class IP	65
Norm of protection class	DIN EN 60529
Flame retardancy	V2
UL-Subject	UL 94
Fully insulated	<input checked="" type="checkbox"/>
Sealing foamed seamless	<input checked="" type="checkbox"/>
Captive cover screws	<input checked="" type="checkbox"/>
Assembly tool	PZ2
Tightening torque cover screws max. (Nm)	2.00
Tightening torque cover screws min. (Nm)	1.00

















### Modifications and Services

Mechanical processing	✓
Finishing and Assembly	✓
Surface design	✓
Special colours	✓
EMC version	✓

### Equipment and accessories

Tragschiene TS 15 Article No. 0311102100	Stahl verzinkt	
Tragschiene TS 35 Article No. 0311104250	Stahl verzinkt	
Montageplatte Hartpapier Article No. 0312101600	Phenolharz Hartpapier	  
Wandlaschen PC (4 Stück) Article No. 0313000015	Polycarbonat	  
Silikon Deckeldichtung Article No. 1980099999	Silikon	
Außenscharniere (2 Stück) Article No. 0314000000	Polycarbonat	
EMV geschützte Ausführung Article No. 1980000118	-	
Innensechskantschrauben Article No. 1980000115	Edelstahl	
GummifüÙe (4 Stück) Article No. 0310000000	Polyurethan	
Tragschienenadapter TSFIX35 Article No. 0314000009	Polyamid 6 (PA6)	  
Adapter Wandmontage Article No. 0413000000	Polycarbonat	  



## INDIVIDUALITY IS OUR STANDARD

With our extensive machinery and a highly motivated team, we transform our standard products into your individual solution.



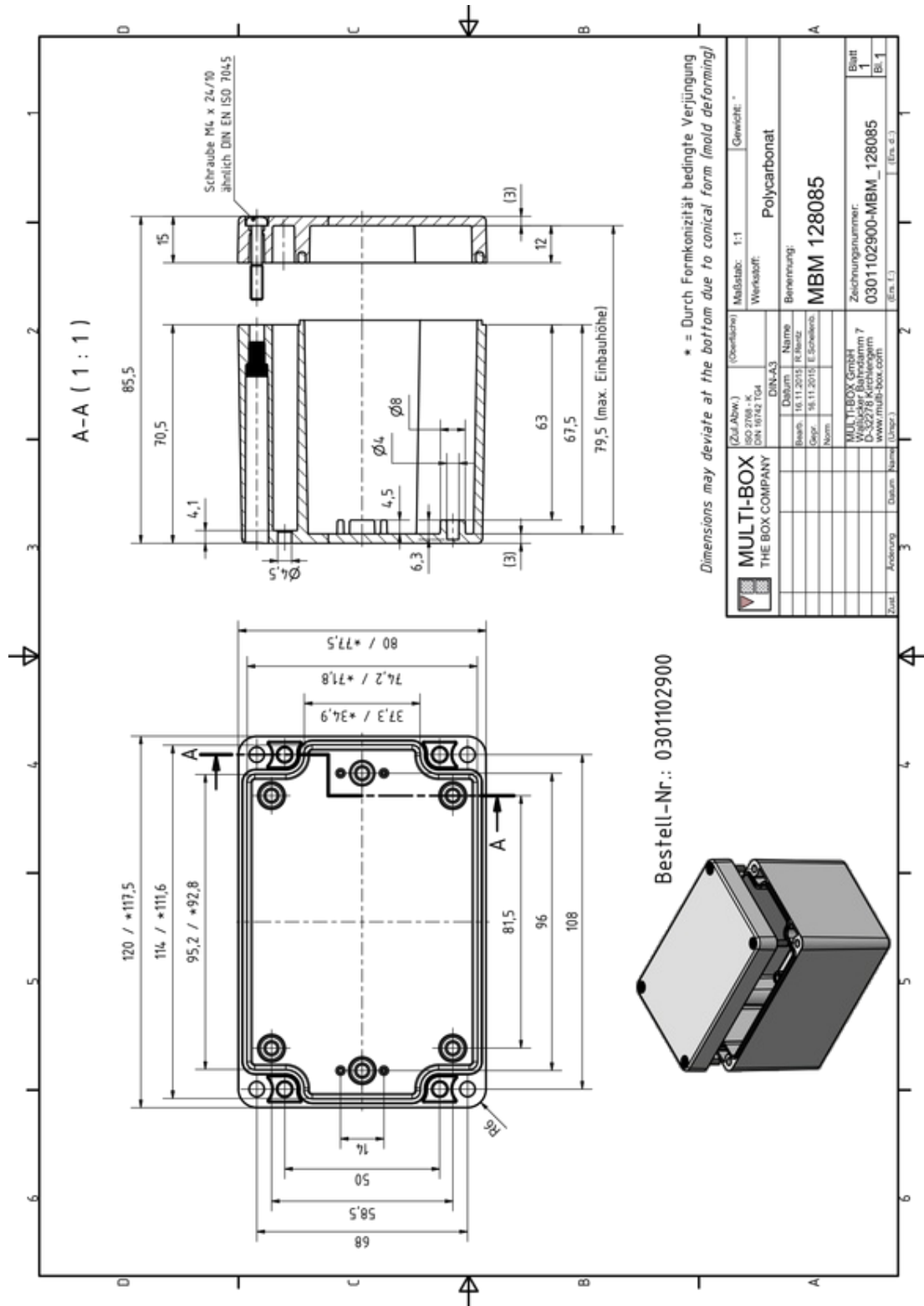

Under the following link you can download a higher resolution version of this drawing, including 3D construction data set:  
<https://www.multi-box.com/gehaeuse/enclosures/industrial-enclosures/plastic-enclosures/polycarbonate-pc-enclosures/mbm/cover-grey/mbm-128085>