



MBM 121275

Article No. 0301104400

Material: Polycarbonate

Protection class: IP65

MBM Enclosures offer excellent properties for the installation of electronic and electrical components as well as complete control systems.

Thanks to the high UV-resistance of the material, these enclosures can be used in both indoor and outdoor areas.

The MBM Enclosures are mechanically processed in a number of ways providing almost no limits with customised surface design, including silk screen printing and membrane keyboards.

The enclosures are available with a grey or transparent cover (K).



We would be glad to assist you!

MULTI-BOX GmbH

Wallücker Bahndamm 7
D-32278 Kirchlengern
Tel. +49 (0)5223 49107-0

info@multi-box.com
www.multi-box.com



Dimensions and weight

Length (mm)	122
Width (mm)	120
Height (mm)	75
Weight (g)	295

Color information

Color description cover	Light grey
RAL-code cover	7035
Color description base	Light grey
RAL-code base	7035

Technical Drawings

PDF	
DXF	
3D	



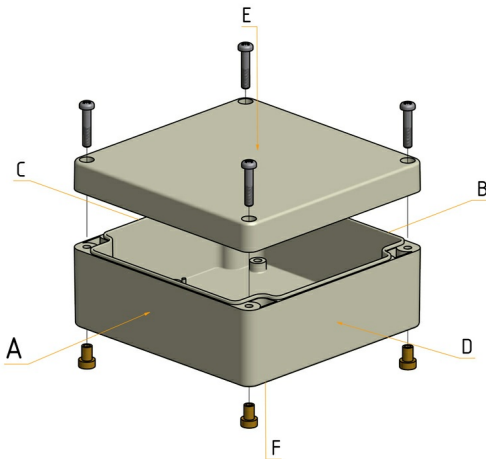

We would be glad to assist you!

MULTI-BOX GmbH

Wallücker Bahndamm 7
D-32278 Kirchlengern
Tel. +49 (0)5223 49107-0

info@multi-box.com
www.multi-box.com

Material information

Material cover	Polycarbonate
Material base	Polycarbonate
Material sealing	Polyurethane
Material screws	Stainless Steel V2 A
Silicone-free	<input checked="" type="checkbox"/>
Halogen-free	<input checked="" type="checkbox"/>
Material UL listed	<input checked="" type="checkbox"/>
UV-resistant	<input checked="" type="checkbox"/>

Temperature resistance and application areas

Permanent operating temperature max. (°C)	100
Permanent operating temperature min. (°C)	-40
Suitable for outdoor use	<input checked="" type="checkbox"/>
Suitable for indoor use	<input checked="" type="checkbox"/>

Technical specifications

Protection class IP	65
Norm of protection class	DIN EN 60529
Flame retardancy	V2
UL-Subject	UL 94
Fully insulated	<input checked="" type="checkbox"/>
Sealing foamed seamless	<input checked="" type="checkbox"/>
Captive cover screws	<input checked="" type="checkbox"/>
Assembly tool	PZ2
Tightening torque cover screws max. (Nm)	2.00
Tightening torque cover screws min. (Nm)	1.00















Modifications and Services

Mechanical processing	<input checked="" type="checkbox"/>
Finishing and Assembly	<input checked="" type="checkbox"/>
Surface design	<input checked="" type="checkbox"/>
Special colours	<input checked="" type="checkbox"/>
EMC version	<input checked="" type="checkbox"/>

Equipment and accessories

Tragschiene TS 15 Article No. 0311104200	Stahl verzinkt	
Tragschiene TS 35 Article No. 0311104250	Stahl verzinkt	
Montageplatte Hartpapier Article No. 0312104100	Phenolharz Hartpapier	  
Wandlaschen PC (4 Stück) Article No. 0313000015	Polycarbonat	  
Silikon Deckeldichtung Article No. 1980099999	Silikon	
Außenscharniere (2 Stück) Article No. 0314000000	Polycarbonat	
EMV geschützte Ausführung Article No. 1980000118	-	
GummifüÙe (4 Stück) Article No. 0310000000	Polyurethan	
Tragschienenadapter TSFIX35 Article No. 0314000009	Polyamid 6 (PA6)	  
Klappfenster KLF Article No. 7003001016	Polycarbonat	



INDIVIDUALITY IS OUR STANDARD

With our extensive machinery and a highly motivated team, we transform our standard products into your individual solution.



