



## MBM 251685

Article No. 0301107300

Material: Polycarbonate

Protection class: IP65

MBM Enclosures offer excellent properties for the installation of electronic and electrical components as well as complete control systems.

Thanks to the high UV-resistance of the material, these enclosures can be used in both indoor and outdoor areas.

The MBM Enclosures are mechanically processed in a number of ways providing almost no limits with customised surface design, including silk screen printing and membrane keyboards.

The enclosures are available with a grey or transparent cover (K).



We would be glad to assist you!

### MULTI-BOX GmbH

Wallücker Bahndamm 7  
D-32278 Kirchlegern  
Tel. +49 (0)5223 49107-0

info@multi-box.com  
www.multi-box.com

### Dimensions and weight

|             |     |
|-------------|-----|
| Length (mm) | 250 |
| Width (mm)  | 160 |
| Height (mm) | 85  |
| Weight (g)  | 686 |

### Color information

|                         |            |
|-------------------------|------------|
| Color description cover | Light grey |
| RAL-code cover          | 7035       |
| Color description base  | Light grey |
| RAL-code base           | 7035       |

### Technical Drawings

PDF



DXF



3D



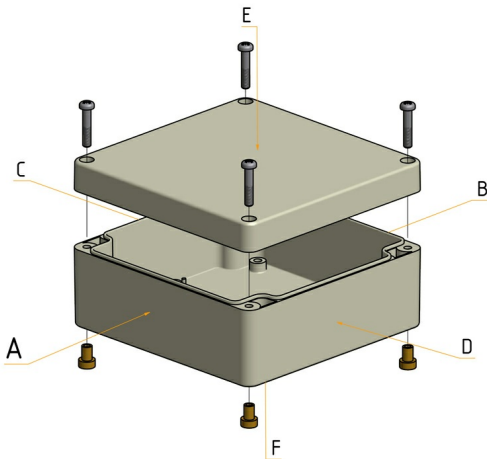

We would be glad to assist you!

**MULTI-BOX GmbH**

Wallücker Bahndamm 7  
D-32278 Kirchlengern  
Tel. +49 (0)5223 49107-0

info@multi-box.com  
www.multi-box.com

**Material information**

|                    |                                     |
|--------------------|-------------------------------------|
| Material cover     | Polycarbonate                       |
| Material base      | Polycarbonate                       |
| Material sealing   | Polyurethane                        |
| Material screws    | Stainless Steel V2 A                |
| Silicone-free      | <input checked="" type="checkbox"/> |
| Halogen-free       | <input checked="" type="checkbox"/> |
| Material UL listed | <input checked="" type="checkbox"/> |
| UV-resistant       | <input checked="" type="checkbox"/> |

**Temperature resistance and application areas**

|   |                                     |
|---|-------------------------------------|
| Permanent operating temperature max. (°C) | 100                                 |
| Permanent operating temperature min. (°C) | -40                                 |
| Suitable for outdoor use                  | <input checked="" type="checkbox"/> |
| Suitable for indoor use                   | <input checked="" type="checkbox"/> |

**Technical specifications**

|  |                                     |
|--|-------------------------------------|
| Protection class IP                      | 65                                  |
| Norm of protection class                 | DIN EN 60529                        |
| Flame retardancy                         | V2                                  |
| UL-Subject                               | UL 94                               |
| Fully insulated                          | <input checked="" type="checkbox"/> |
| Sealing foamed seamless                  | <input checked="" type="checkbox"/> |
| Captive cover screws                     | <input checked="" type="checkbox"/> |
| Assembly tool                            | PZ2                                 |
| Tightening torque cover screws max. (Nm) | 2.00                                |
| Tightening torque cover screws min. (Nm) | 1.00                                |















### Modifications and Services

|                        |   |
|------------------------|---|
| Mechanical processing  |  |
| Finishing and Assembly |  |
| Surface design         |  |
| Special colours        |  |
| EMC version            |  |

### Equipment and accessories

|   |                       |   |
|---|-----------------------|---|
| Montageplatte Hartpapier<br>Article No. 0312107200    | Phenolharz Hartpapier |          |
| Wandlaschen PC (4 Stück)<br>Article No. 0313000015    | Polycarbonat          |          |
| Silikon Deckeldichtung<br>Article No. 1980099999      | Silikon               |   |
| Außenscharniere (2 Stück)<br>Article No. 0314000000   | Polycarbonat          |    |
| EMV geschützte Ausführung<br>Article No. 1980000118   | -                     |   |
| Gummifüße (4 Stück)<br>Article No. 0310000000         | Polyurethan           |   |
| Tragschienenadapter TSFIX35<br>Article No. 0314000009 | Polyamid 6 (PA6)      |    |
| Klappfenster KLF<br>Article No. 7003001016            | Polycarbonat          |   |





## INDIVIDUALITY IS OUR STANDARD

With our extensive machinery and a highly motivated team, we transform our standard products into your individual solution.



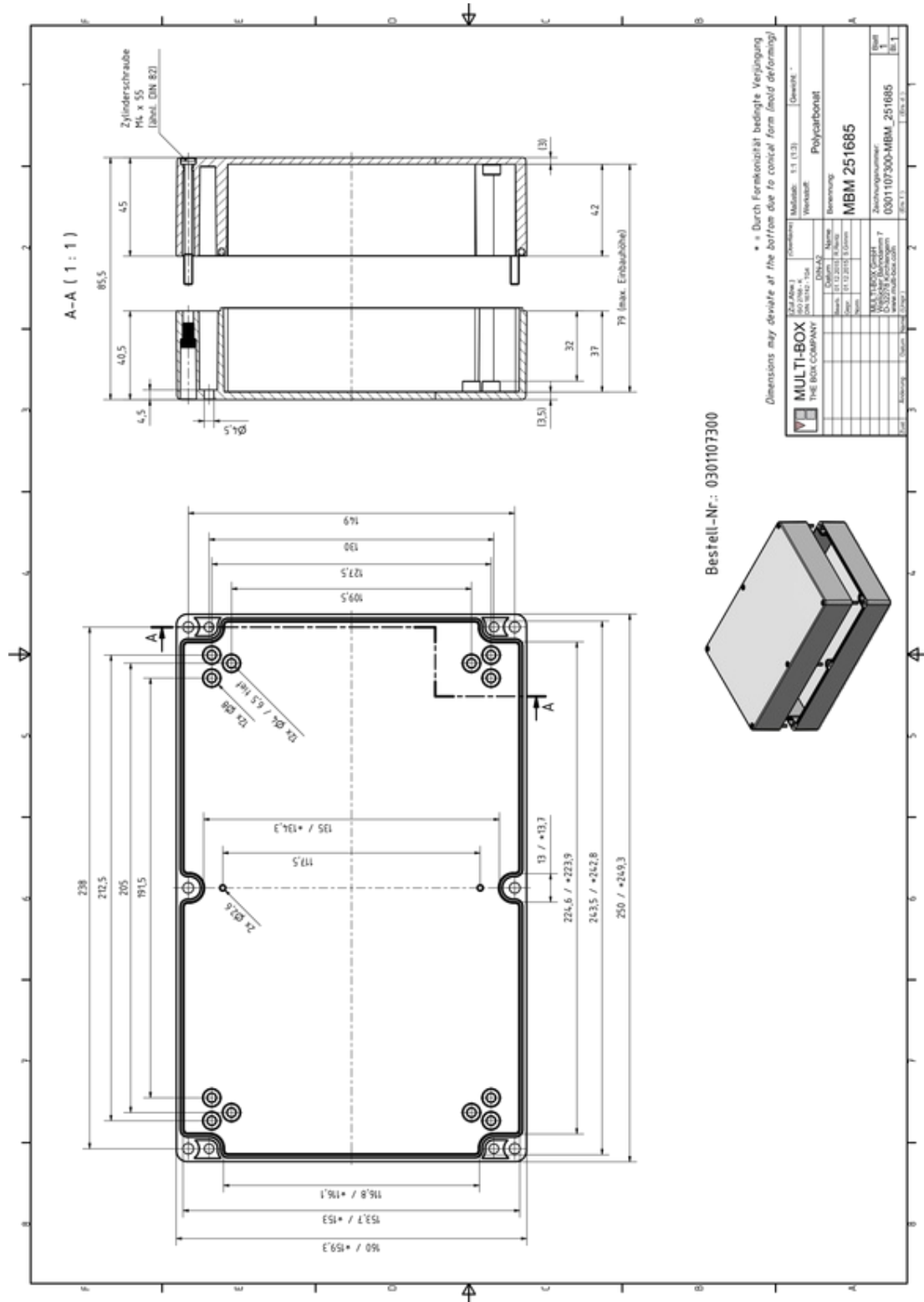

Under the following link you can download a higher resolution version of this drawing, including 3D construction data set:  
<https://www.multi-box.com/gehaeuse/enclosures/industrial-enclosures/plastic-enclosures/polycarbonate-pc-enclosures/mbm/cover-grey/mbm-251685>