



## MBT 128055

Article No. 0401102120

Material: ABS

Protection class: IP65

It doesn't always need to be grey!

With our Multi-Colour-Enclosures made of ABS, we offer the possibility of designing the colour of your products and visually upgrading them even for small quantities.

Multi-Colour-Enclosures offer excellent properties for "packaging" electronic and electrical components as well as complete control systems in indoor areas.

Our enclosures can be mechanically processed in a number of ways and there are almost no limits to customised surface design with silk screen printing or membrane keyboards.

We would be glad to assist you!

### MULTI-BOX GmbH

Wallücker Bahndamm 7  
D-32278 Kirchlegern  
Tel. +49 (0)5223 49107-0

info@multi-box.com  
www.multi-box.com

The enclosures are available with a coloured or transparent cover (K).



### Dimensions and weight

|             |     |
|-------------|-----|
| Length (mm) | 120 |
| Width (mm)  | 80  |
| Height (mm) | 55  |

### Color information

|                         |               |
|-------------------------|---------------|
| Color description cover | Signal yellow |
| RAL-code cover          | 1023          |
| Color description base  | Signal yellow |
| RAL-code base           | 1023          |



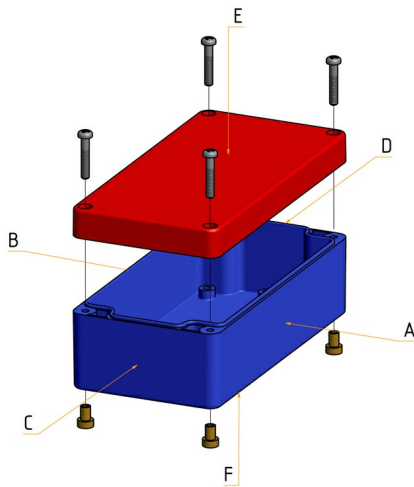

We would be glad to assist you!

**MULTI-BOX GmbH**

Wallücker Bahndamm 7  
D-32278 Kirchlengern  
Tel. +49 (0)5223 49107-0

info@multi-box.com  
www.multi-box.com



**Material information**

|                  |                      |
|------------------|----------------------|
| Material cover   | ABS                  |
| Material base    | ABS                  |
| Material sealing | Polyurethane         |
| Material screws  | Stainless steel V2 A |
| Silicone-free    | ✓                    |
| Halogen-free     | ✓                    |

**Temperature resistance and application areas**

|   |     |
|---|-----|
| Permanent operating temperature max. (°C) | 80  |
| Permanent operating temperature min. (°C) | -40 |
| Suitable for indoor use                   | ✓   |

**Technical specifications**













|  |              |
|--|--------------|
| Protection class IP                      | 65           |
| Norm of protection class                 | DIN EN 60529 |
| Flame retardancy                         | HB           |
| UL-Subject                               | UL 94        |
| Fully insulated                          | ✓            |
| Sealing foamed seamless                  | ✓            |
| Captive cover screws                     | ✓            |
| Assembly tool                            | PZ2          |
| Tightening torque cover screws max. (Nm) | 2.00         |
| Tightening torque cover screws min. (Nm) | 1.00         |



### Modifications and Services

|                        |   |
|------------------------|---|
| Mechanical processing  |  |
| Finishing and Assembly |  |
| Surface design         |  |
| Special colours        |  |
| EMC version            |  |

### Equipment and accessories

|   |                       |   |
|---|-----------------------|---|
| Tragschiene TS 15<br>Article No. 0311102100           | Stahl verzinkt        |   |
| Tragschiene TS 35<br>Article No. 0311104250           | Stahl verzinkt        |   |
| Montageplatte Hartpapier<br>Article No. 0312101600    | Phenolharz Hartpapier |       |
| Wandlaschen PC (4 Stück)<br>Article No. 0313000015    | Polycarbonat          |    |
| Silikon Deckeldichtung<br>Article No. 1980099999      | Silikon               |   |
| Außenscharniere (2 Stück)<br>Article No. 0314000000   | Polycarbonat          |    |
| EMV geschützte Ausführung<br>Article No. 1980000118   | -                     |   |
| Innensechskantschrauben<br>Article No. 1980000115     | Edelstahl             |   |
| GummifüÙe (4 Stück)<br>Article No. 0310000000         | Polyurethan           |   |
| Tragschienenadapter TSFIX35<br>Article No. 0314000009 | Polyamid 6 (PA6)      |    |
| Adapter Wandmontage<br>Article No. 0413000000         | Polycarbonat          |    |



## INDIVIDUALITY IS OUR STANDARD

With our extensive machinery and a highly motivated team, we transform our standard products into your individual solution.

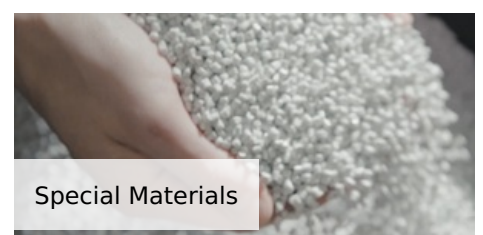
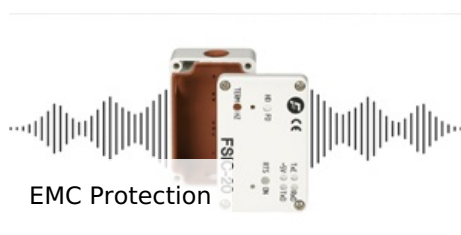
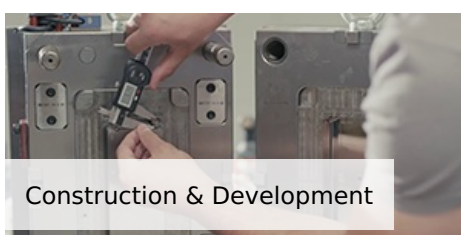
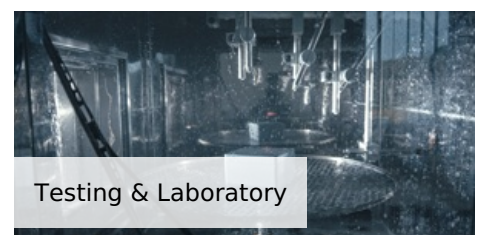
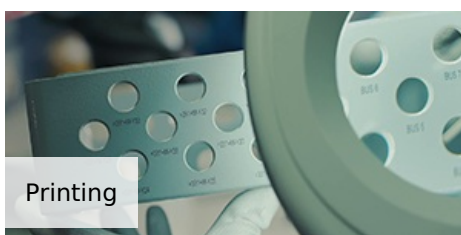

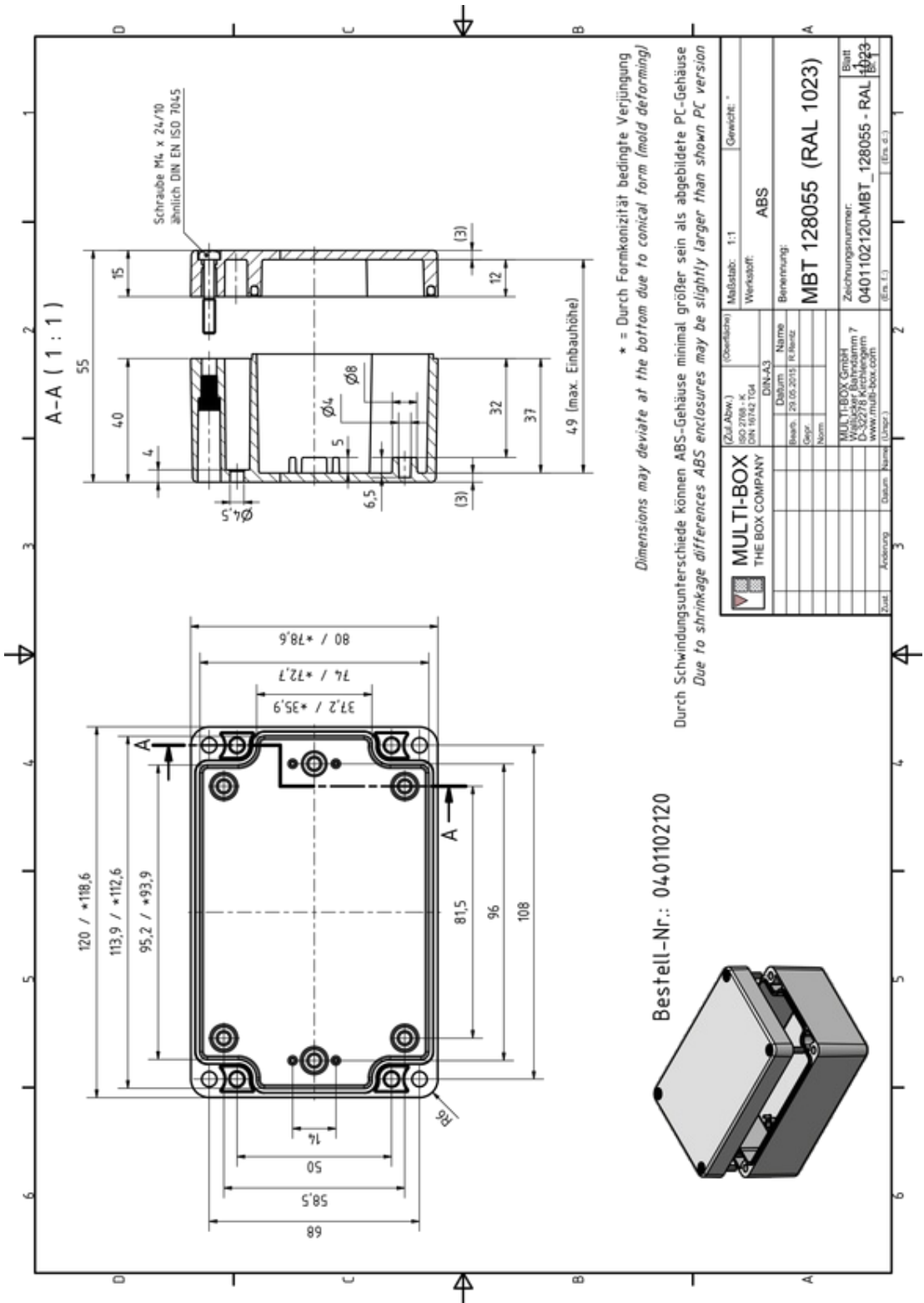

Under the following link you can download a higher resolution version of this drawing, including 3D construction data set:  
<https://www.multi-box.com/gehaeuse/enclosures/kunststoffgehaeuse/ral-1023-yellow/mbt-128055-2>