



MBT 168055

Article No. 0401103530

Material: ABS

Protection class: IP65

It doesn't always need to be grey!

With our Multi-Colour-Enclosures made of ABS, we offer the possibility of designing the colour of your products and visually upgrading them even for small quantities.

Multi-Colour-Enclosures offer excellent properties for "packaging" electronic and electrical components as well as complete control systems in indoor areas.

Our enclosures can be mechanically processed in a number of ways and there are almost no limits to customised surface design with silk screen printing or membrane keyboards.

We would be glad to assist you!

MULTI-BOX GmbH

Wallücker Bahndamm 7
D-32278 Kirchlegern
Tel. +49 (0)5223 49107-0

info@multi-box.com
www.multi-box.com

The enclosures are available with a coloured or transparent cover (K).



Dimensions and weight

Length (mm)	160
Width (mm)	80
Height (mm)	55

Color information

Color description cover	Signal red
RAL-code cover	3020
Color description base	Signal red
RAL-code base	3020



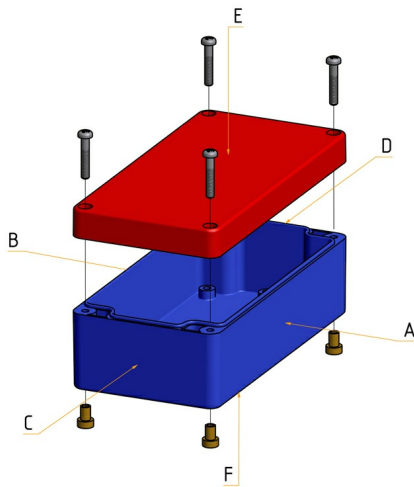

We would be glad to assist you!

MULTI-BOX GmbH

Wallücker Bahndamm 7
D-32278 Kirchlegern
Tel. +49 (0)5223 49107-0

info@multi-box.com
www.multi-box.com



Material information

Material cover	ABS
Material base	ABS
Material sealing	Polyurethane
Material screws	Stainless steel V2 A
Silicone-free	✓
Halogen-free	✓

Temperature resistance and application areas

Permanent operating temperature max. (°C)	80
Permanent operating temperature min. (°C)	-40
Suitable for indoor use	✓

Technical specifications













Protection class IP	65
Norm of protection class	DIN EN 60529
Flame retardancy	HB
UL-Subject	UL 94
Fully insulated	✓
Sealing foamed seamless	✓
Captive cover screws	✓
Assembly tool	PZ2
Tightening torque cover screws max. (Nm)	2.00
Tightening torque cover screws min. (Nm)	1.00



Modifications and Services

Mechanical processing	
Finishing and Assembly	
Surface design	
Special colours	
EMC version	

Equipment and accessories

Tragschiene TS 15 Article No. 0311103500	Stahl verzinkt	
Tragschiene TS 35 Article No. 0311103550	Stahl verzinkt	
Montageplatte Hartpapier Article No. 0312103400	Phenolharz Hartpapier	  
Wandlaschen PC (4 Stück) Article No. 0313000015	Polycarbonat	  
Silikon Deckeldichtung Article No. 1980099999	Silikon	
Außenscharniere (2 Stück) Article No. 0314000000	Polycarbonat	
EMV geschützte Ausführung Article No. 1980000118	-	
Innensechskantschrauben Article No. 1980000115	Edelstahl	
GummifüÙe (4 Stück) Article No. 0310000000	Polyurethan	
Tragschienenadapter TSFIX35 Article No. 0314000009	Polyamid 6 (PA6)	  
Adapter Wandmontage Article No. 0413000000	Polycarbonat	  



INDIVIDUALITY IS OUR STANDARD

With our extensive machinery and a highly motivated team, we transform our standard products into your individual solution.

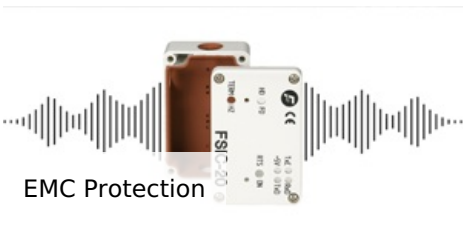
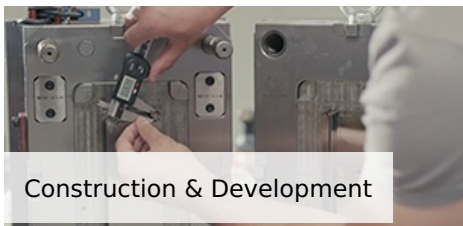
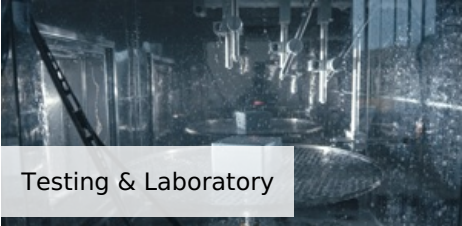

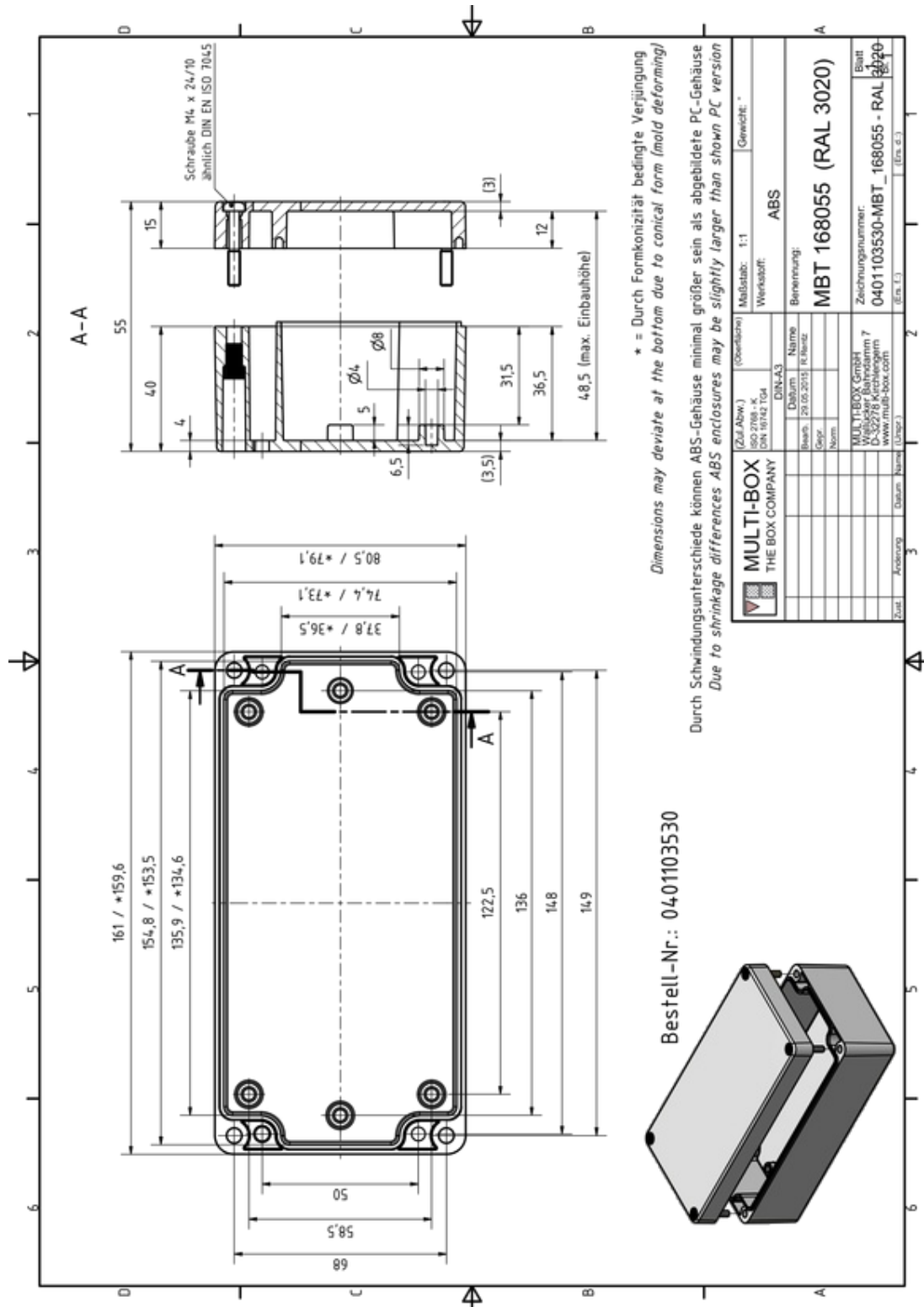

Under the following link you can download a higher resolution version of this drawing, including 3D construction data set:
<https://www.multi-box.com/gehaeuse/enclosures/kunststoffgehaeuse/ral-3020-red/mbt-168055-1>