



MBT 121255

Article No. 0401104250

Material: ABS

Protection class: IP65

It doesn't always need to be grey!

With our Multi-Colour-Enclosures made of ABS, we offer the possibility of designing the colour of your products and visually upgrading them even for small quantities.

Multi-Colour-Enclosures offer excellent properties for "packaging" electronic and electrical components as well as complete control systems in indoor areas.

Our enclosures can be mechanically processed in a number of ways and there are almost no limits to customised surface design with silk screen printing or membrane keyboards.

We would be glad to assist you!

MULTI-BOX GmbH

Wallücker Bahndamm 7
D-32278 Kirchlengern
Tel. +49 (0)5223 49107-0

info@multi-box.com
www.multi-box.com

The enclosures are available with a coloured or transparent cover (K).



Dimensions and weight

| | |
|-------------|-----|
| Length (mm) | 122 |
| Width (mm) | 120 |
| Height (mm) | 55 |

Color information

| | |
|-------------------------|-------------|
| Color description cover | Signal blue |
| RAL-code cover | 5017 |
| Color description base | Signal blue |
| RAL-code base | 5017 |



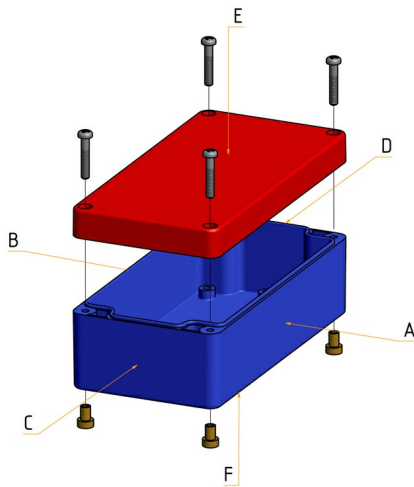

We would be glad to assist you!

MULTI-BOX GmbH

Wallücker Bahndamm 7
D-32278 Kirchlengern
Tel. +49 (0)5223 49107-0

info@multi-box.com
www.multi-box.com



Material information

| | |
|------------------|----------------------|
| Material cover | ABS |
| Material base | ABS |
| Material sealing | Polyurethane |
| Material screws | Stainless steel V2 A |
| Silicone-free | ✓ |
| Halogen-free | ✓ |

Temperature resistance and application areas



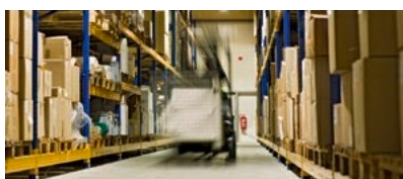

| | |
|---|-----|
| Permanent operating temperature max. (°C) | 80 |
| Permanent operating temperature min. (°C) | -40 |
| Suitable for indoor use | ✓ |

Technical specifications











| | |
|--|--------------|
| Protection class IP | 65 |
| Norm of protection class | DIN EN 60529 |
| Flame retardancy | HB |
| UL-Subject | UL 94 |
| Fully insulated | ✓ |
| Sealing foamed seamless | ✓ |
| Captive cover screws | ✓ |
| Assembly tool | PZ2 |
| Tightening torque cover screws max. (Nm) | 2.00 |
| Tightening torque cover screws min. (Nm) | 1.00 |



Modifications and Services

| | |
|------------------------|---|
| Mechanical processing |  |
| Finishing and Assembly |  |
| Surface design |  |
| Special colours |  |
| EMC version |  |

Equipment and accessories

| | | |
|---|-----------------------|---|
| Tragschiene TS 15 Article No. 0311104200 | Stahl verzinkt | |
| Tragschiene TS 35 Article No. 0311104250 | Stahl verzinkt | |
| Montageplatte Hartpapier Article No. 0312104100 | Phenolharz Hartpapier |    |
| Wandlaschen PC (4 Stück) Article No. 0313000015 | Polycarbonat |    |
| Silikon Deckeldichtung Article No. 1980099999 | Silikon | |
| Außenscharniere (2 Stück) Article No. 0314000000 | Polycarbonat |  |
| EMV geschützte Ausführung Article No. 1980000118 | - | |
| Innensechskantschrauben Article No. 1980000115 | Edelstahl | |
| GummifüÙe (4 Stück) Article No. 0310000000 | Polyurethan | |
| Tragschienenadapter TSFIX35 Article No. 0314000009 | Polyamid 6 (PA6) |    |
| Klappfenster KLF Article No. 7003001016 | Polycarbonat | |



INDIVIDUALITY IS OUR STANDARD

With our extensive machinery and a highly motivated team, we transform our standard products into your individual solution.

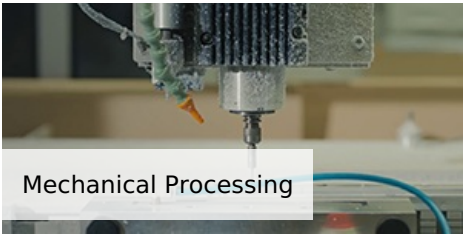

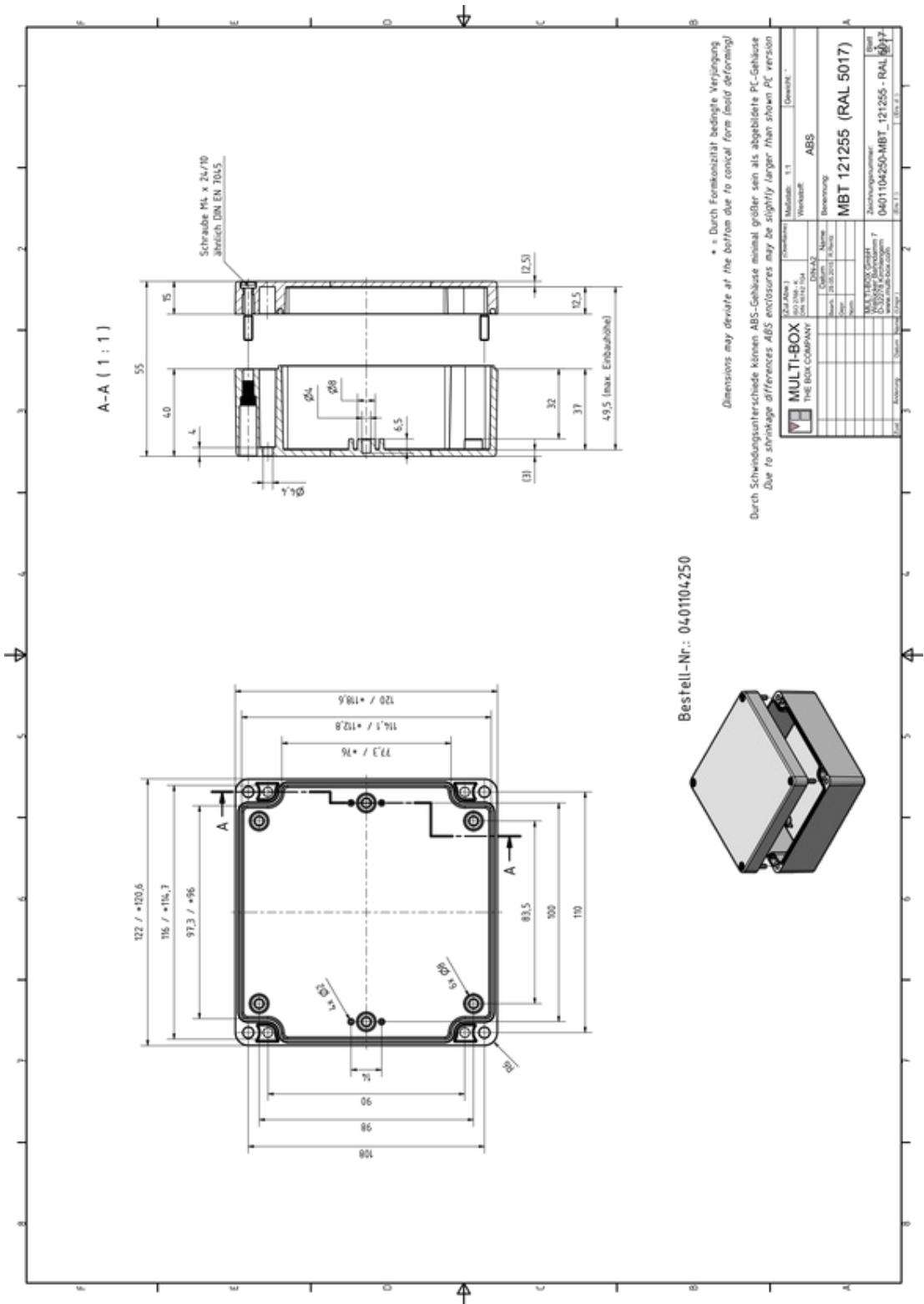

Bestell-Nr.: 0401104250

Under the following link you can download a higher resolution version of this drawing, including 3D construction data set:
<https://www.multi-box.com/gehaeuse/enclosures/kunststoffgehaeuse/ral-5017-blue/mbt-121255-3>