



## MBT 161255

Article No. 0401104950

Material: ABS

Protection class: IP65

It doesn't always need to be grey!

With our Multi-Colour-Enclosures made of ABS, we offer the possibility of designing the colour of your products and visually upgrading them even for small quantities.

Multi-Colour-Enclosures offer excellent properties for "packaging" electronic and electrical components as well as complete control systems in indoor areas.

Our enclosures can be mechanically processed in a number of ways and there are almost no limits to customised surface design with silk screen printing or membrane keyboards.

We would be glad to assist you!

### MULTI-BOX GmbH

Wallücker Bahndamm 7  
D-32278 Kirchlengern  
Tel. +49 (0)5223 49107-0

info@multi-box.com  
www.multi-box.com

The enclosures are available with a coloured or transparent cover (K).



### Dimensions and weight

|             |     |
|-------------|-----|
| Length (mm) | 160 |
| Width (mm)  | 120 |
| Height (mm) | 55  |

### Color information

|                         |            |
|-------------------------|------------|
| Color description cover | Deep black |
| RAL-code cover          | 9005       |
| Color description base  | Deep black |
| RAL-code base           | 9005       |



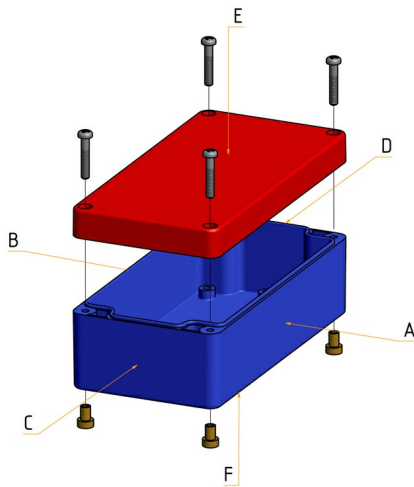

We would be glad to assist you!

**MULTI-BOX GmbH**

Wallücker Bahndamm 7  
D-32278 Kirchlegern  
Tel. +49 (0)5223 49107-0

info@multi-box.com  
www.multi-box.com



**Material information**

|                    |                      |
|--------------------|----------------------|
| Material cover     | ABS                  |
| Material base      | ABS                  |
| Material sealing   | Polyurethane         |
| Material screws    | Stainless Steel V2 A |
| Silicone-free      | ✓                    |
| Halogen-free       | ✓                    |
| Material UL listed | ✓                    |

**Temperature resistance and application areas**

|   |     |
|---|-----|
| Permanent operating temperature max. (°C) | 80  |
| Permanent operating temperature min. (°C) | -40 |
| Suitable for indoor use                   | ✓   |

**Technical specifications**











|  |              |
|--|--------------|
| Protection class IP                      | 65           |
| Norm of protection class                 | DIN EN 60529 |
| Flame retardancy                         | HB           |
| UL-Subject                               | UL 94        |
| Fully insulated                          | ✓            |
| Sealing foamed seamless                  | ✓            |
| Captive cover screws                     | ✓            |
| Assembly tool                            | PZ2          |
| Tightening torque cover screws max. (Nm) | 2.00         |
| Tightening torque cover screws min. (Nm) | 1.00         |



### Modifications and Services

|                        |   |
|------------------------|---|
| Mechanical processing  | ✓ |
| Finishing and Assembly | ✓ |
| Surface design         | ✓ |
| Special colours        | ✓ |
| EMC version            | ✓ |

### Equipment and accessories

|   |                       |   |
|---|-----------------------|---|
| Montageplatte Hartpapier<br>Article No. 0312104900    | Phenolharz Hartpapier |          |
| Wandlaschen PC (4 Stück)<br>Article No. 0313000015    | Polycarbonat          |          |
| Silikon Deckeldichtung<br>Article No. 1980099999      | Silikon               |   |
| Außenscharniere (2 Stück)<br>Article No. 0314000000   | Polycarbonat          |    |
| EMV geschützte Ausführung<br>Article No. 1980000118   | -                     |   |
| Innensechskantschrauben<br>Article No. 1980000115     | Edelstahl             |   |
| Gummifüße (4 Stück)<br>Article No. 0310000000         | Polyurethan           |   |
| Tragschienenadapter TSFIX35<br>Article No. 0314000009 | Polyamid 6 (PA6)      |    |
| Klappfenster KLF<br>Article No. 7003001016            | Polycarbonat          |   |





## INDIVIDUALITY IS OUR STANDARD

With our extensive machinery and a highly motivated team, we transform our standard products into your individual solution.

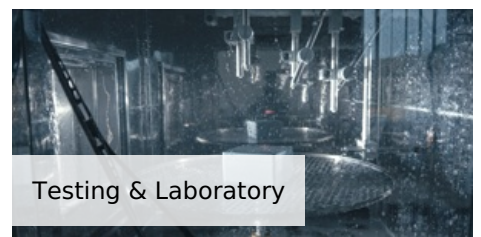

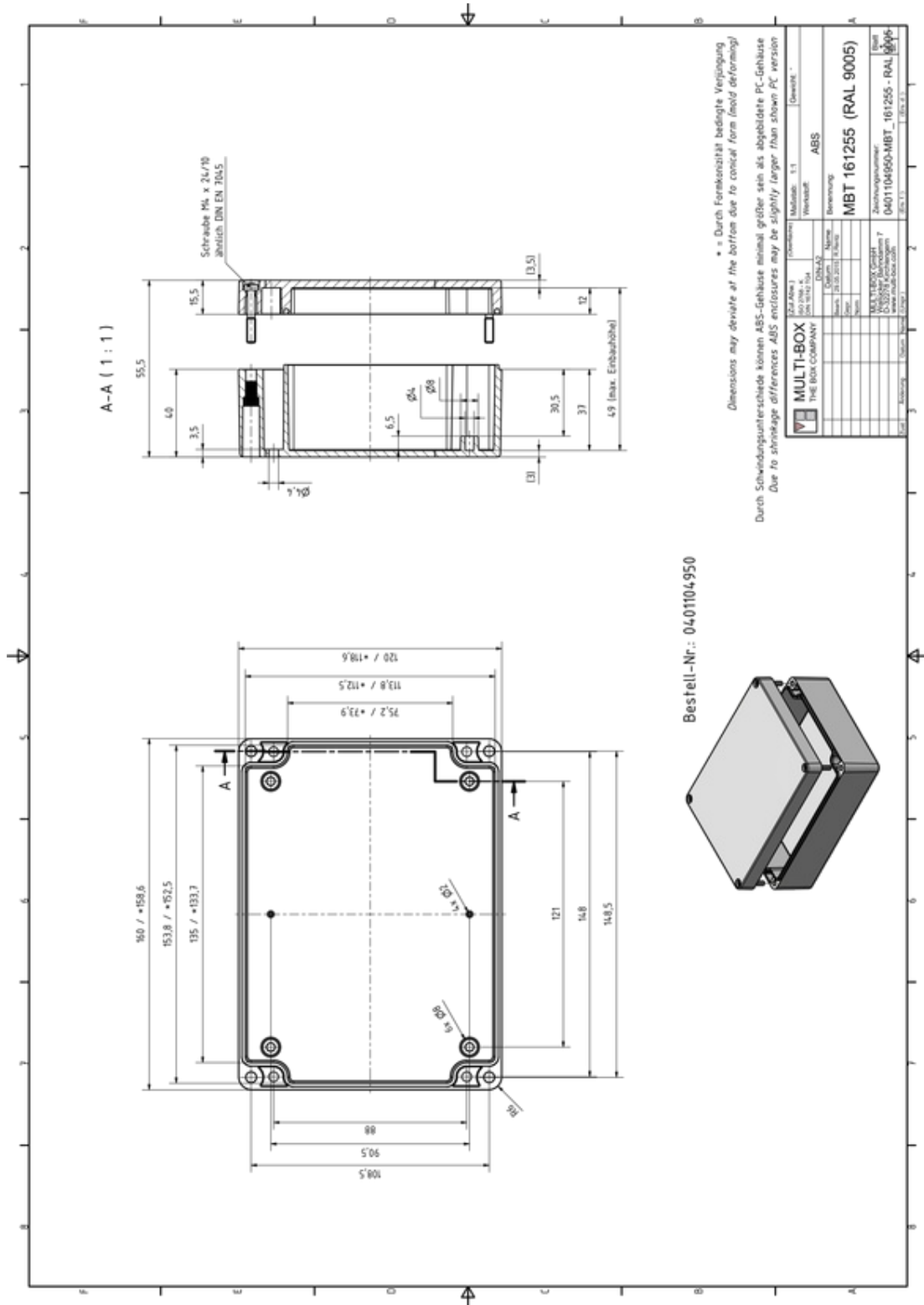

Under the following link you can download a higher resolution version of this drawing, including 3D construction data set:  
<https://www.multi-box.com/gehaeuse/enclosures/kunststoffgehaeuse/ral-9005-black/mbt-161255-4>