



## MBT 241270K

Article No. 0402106900

Material: ABS

Protection class: IP65

MBT Enclosures offer excellent properties for the installation of electronic and electrical components as well as complete control systems for indoor applications.

The MBT Enclosures can be mechanically processed in a number of ways providing almost no limits to customised surface design, including silk screen printing and membrane keyboards.

The enclosures are available with a grey or transparent cover (K).



We would be glad to assist you!

### MULTI-BOX GmbH

Wallücker Bahndamm 7  
D-32278 Kirchlegern  
Tel. +49 (0)5223 49107-0

info@multi-box.com  
www.multi-box.com

### Dimensions and weight

Length (mm)	240
Width (mm)	120
Height (mm)	70
Weight (g)	443

### Color information

Color description cover	Transparent
Color description base	Light grey
RAL-code base	7035

### Technical Drawings

PDF



DXF



3D



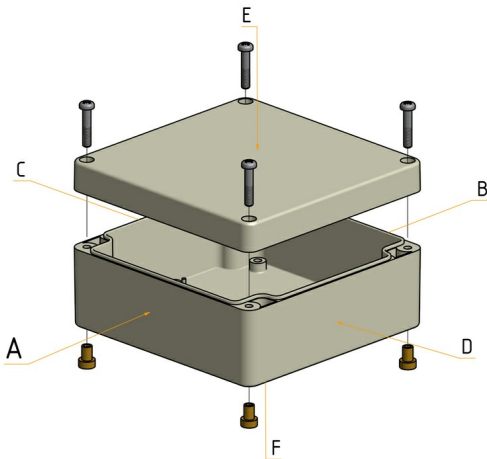

We would be glad to assist you!

**MULTI-BOX GmbH**

Wallücker Bahndamm 7  
D-32278 Kirchlegern  
Tel. +49 (0)5223 49107-0

info@multi-box.com  
www.multi-box.com



Material information

Material cover	Polycarbonate
Material base	ABS
Material sealing	Polyurethane
Material screws	Stainless Steel V2 A
Silicone-free	✓
Halogen-free	✓
Material UL listed	✓

Temperature resistance and application areas

Permanent operating temperature max. (°C)	80
Permanent operating temperature min. (°C)	-40
Suitable for indoor use	✓

Technical specifications











Protection class IP	65
Norm of protection class	DIN EN 60529
Flame retardancy	HB
UL-Subject	UL 94
Fully insulated	✓
Sealing foamed seamless	✓
Captive cover screws	✓
Assembly tool	PZ2
Tightening torque cover screws max. (Nm)	2.00
Tightening torque cover screws min. (Nm)	1.00



### Modifications and Services

Mechanical processing	
Finishing and Assembly	
Surface design	
Special colours	
EMC version	

### Equipment and accessories

Tragschiene TS 15 Article No. 0311106900	Stahl verzinkt	
Tragschiene TS 35 Article No. 0311106950	Stahl verzinkt	
Montageplatte Hartpapier Article No. 0312106800	Phenolharz Hartpapier	  
Wandlaschen PC (4 Stück) Article No. 0313000015	Polycarbonat	  
Silikon Deckeldichtung Article No. 1980099999	Silikon	
Außenscharniere (2 Stück) Article No. 0314000000	Polycarbonat	
GummifüÙe (4 Stück) Article No. 0310000000	Polyurethan	
Tragschienenadapter TSFIX35 Article No. 0314000009	Polyamid 6 (PA6)	  
Klappfenster KLF Article No. 7003001016	Polycarbonat	



## INDIVIDUALITY IS OUR STANDARD

With our extensive machinery and a highly motivated team, we transform our standard products into your individual solution.

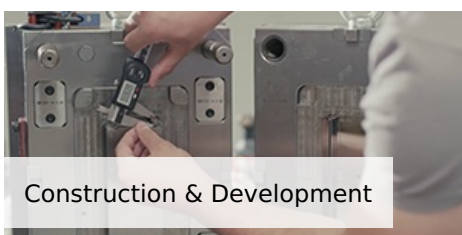
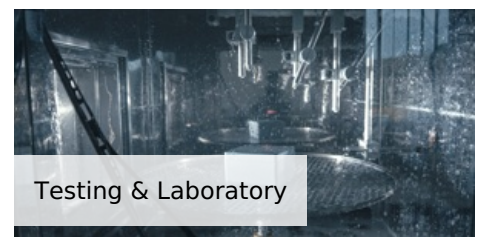
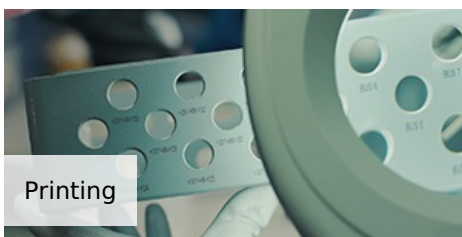

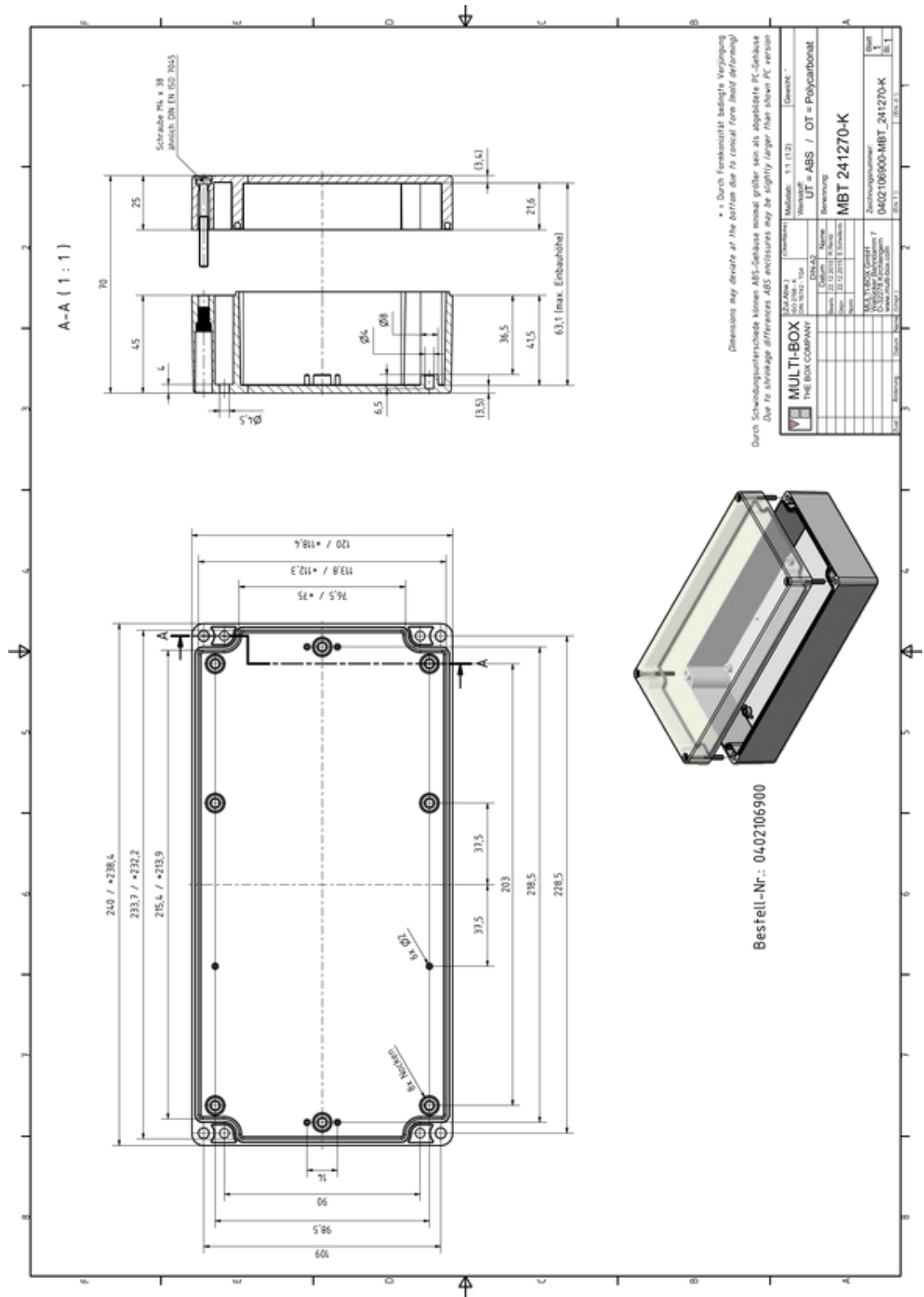

Under the following link you can download a higher resolution version of this drawing, including 3D construction data set:  
<https://www.multi-box.com/gehaeuse/enclosures/industrial-enclosures/plastic-enclosures/abs-enclosures/mbt/cover-clear/mbt-241270k>