



## MBI-PC 111109 O

Article No. 0901101190

Material: Polycarbonate GF10

Protection class: IP66

The MBI enclosure series is characterised by a wide range of sizes and a systematic focus on requirements in industrial installations. MBI enclosure bases are designed with plane side walls. These can be mechanically processed according to customer requirements. Covers are supplied in a light grey colour.

MBI enclosures are made of glass fibre reinforced polycarbonate in light grey colour RAL 7035. The material is UV-resistant (UL 746C F1) and self-extinguishing (UL 94 V0). Depending on quantities, the enclosures can be produced in special colours.

With a seamlessly foamed 2-component polyurethane gasket, all types achieve protection class IP66. The cover screws are made of plastic material and therefore they are completely corrosion-free. The impact resistance of the enclosures corresponds to IK08, making the MBI series ideally suitable for use in industrial and outdoor applications.

MBI enclosures offer a variety of mounting points for direct fixation of components into the base. The self-forming plastic screws for assembly are included in the scope of delivery.

There are several ways to mount the enclosures to walls or machines. With the cover opened, mounting can be done through wall mounting channels outside the sealing area. Alternatively, there are pre-formed knockouts on the enclosure base. With the cover closed, the enclosures can be fastened with external wall brackets. Another option is mounting with M4 screws from the rear side into pressed-in thread bushes in the bottom of the enclosure.

Depending on quantities, we can produce customer-specific mould sides. Individual knockouts, cutouts and hole designs can be implemented in the injection mould and there is no requirement for further mechanical processing.

We would be glad to assist you!

### MULTI-BOX GmbH

Wallücker Bahndamm 7  
D-32278 Kirchlengern  
Tel. +49 (0)5223 49107-0

info@multi-box.com  
www.multi-box.com



### Dimensions and weight

Length (mm)	110
Width (mm)	110
Height (mm)	90
Weight (g)	290

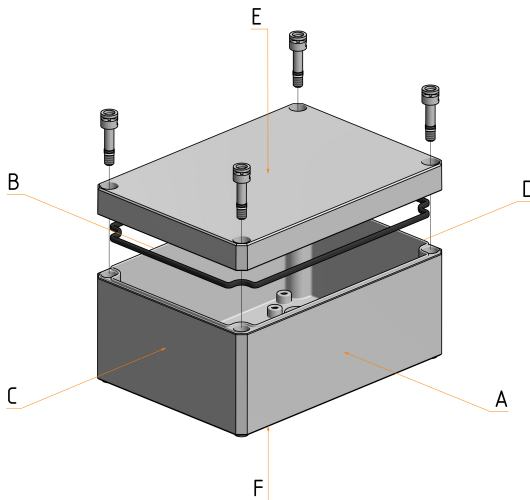

We would be glad to assist you!

**MULTI-BOX GmbH**

Wallücker Bahndamm 7  
D-32278 Kirchlegern  
Tel. +49 (0)5223 49107-0

info@multi-box.com  
www.multi-box.com

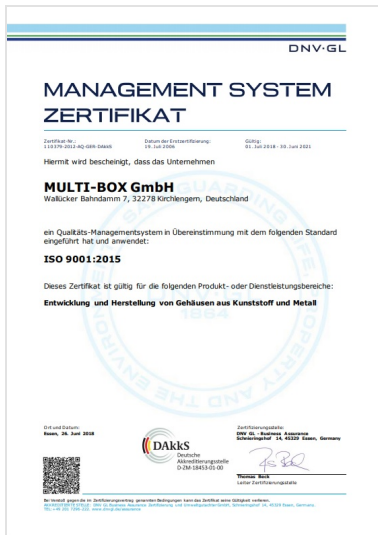

**Material information**

Material cover	Polycarbonate GF10
Material base	Polycarbonate GF10
Material sealing	Polyurethane
Material screws	Plastic
Silicone-free	<input checked="" type="checkbox"/>
Halogen-free	<input checked="" type="checkbox"/>
Material UL listed	<input checked="" type="checkbox"/>
UV-resistant	<input checked="" type="checkbox"/>

**Temperature resistance and application areas**

Permanent operating temperature max. (°C)	100
Permanent operating temperature min. (°C)	-40
Suitable for outdoor use	<input checked="" type="checkbox"/>
Suitable for indoor use	<input checked="" type="checkbox"/>

**Technical specifications**

Protection class IP	66
Norm of protection class	DIN EN 60529
Impact resistance IK	08
Norm of impact resistance	EN 50102
Flame retardancy	V-0
UL-Subject	UL 94
Fully insulated	<input checked="" type="checkbox"/>
Sealing foamed seamless	<input checked="" type="checkbox"/>
Captive cover screws	<input checked="" type="checkbox"/>
Assembly tool	SL 5,5
Tightening torque cover screws max. (Nm)	1.4
Tightening torque cover screws min. (Nm)	1



### Modifications and Services

- Mechanical processing ✔
- Finishing and Assembly ✔
- Surface design ✔
- Special colours ✔
- Special materials ✔

### Equipment and accessories

Tragschiene TS 35 Article No. 0911100004	Stahl verzinkt	
Montageplatte Hartpapier Article No. 0912111110	Phenolharz Hartpapier	  
Wandlaschen MBI (4 Stück) Article No. 0313000032	Polycarbonat GF10	  
Wandmontagebuchsen M4 (4 Stück) Article No. 1999000095	Messing vernickelt / Edelstahl	
Außenscharniere (2 Stück) Article No. 0314000000	Polycarbonat	





## INDIVIDUALITY IS OUR STANDARD

With our extensive machinery and a highly motivated team, we transform our standard products into your individual solution.



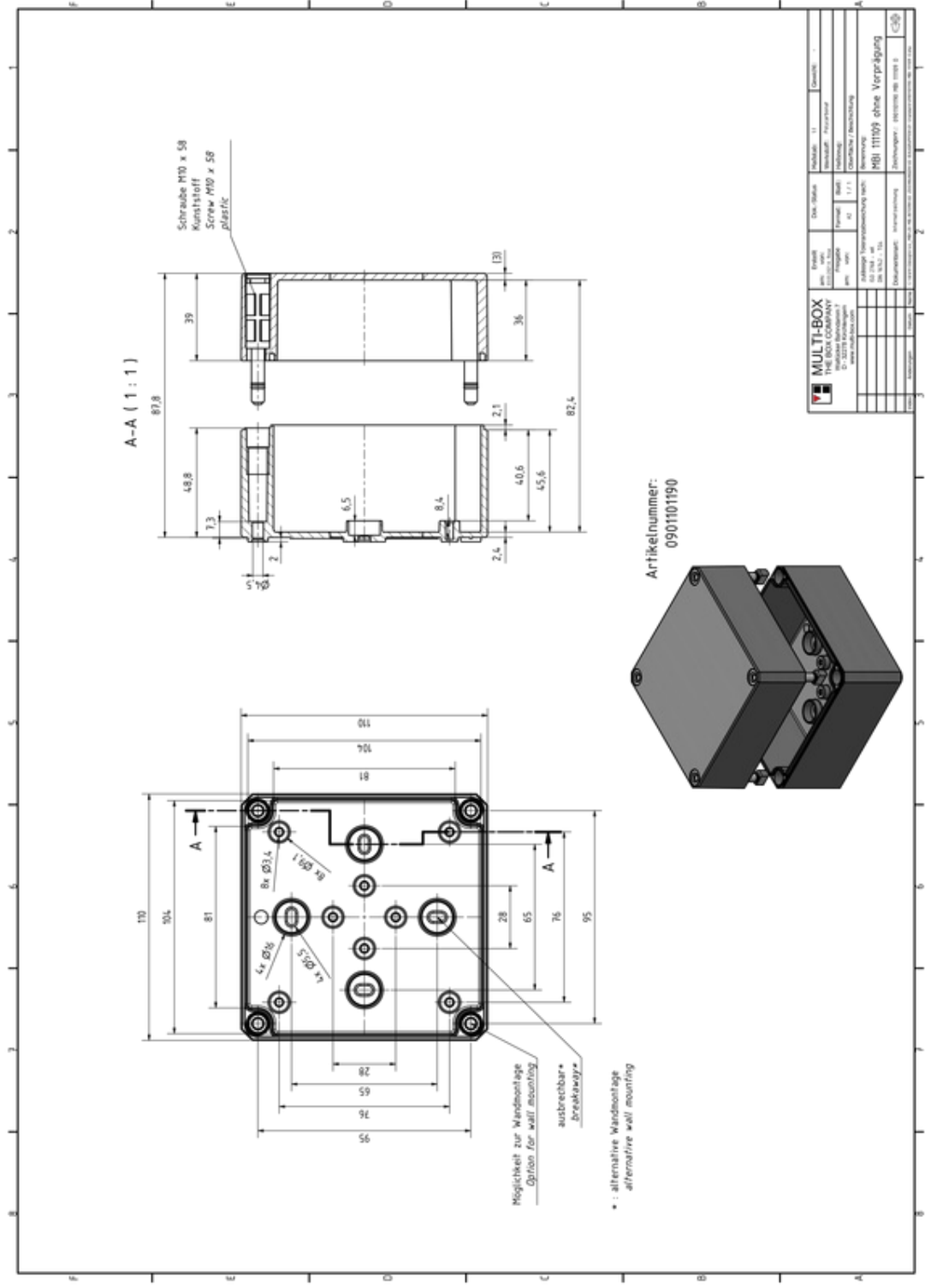

Under the following link you can download a higher resolution version of this drawing, including 3D construction data set:

<https://www.multi-box.com/gehaeuse/enclosures/industrial-enclosures/plastic-enclosures/polycarbonate-pc-enclosures/mbi/o/mbi-pc-111109-o>