



## MBI-PC 070708 OK

Article No. 0903107780

Material: Polycarbonate GF10

Protection class: IP66

The MBI enclosure series is characterised by a wide range of sizes and a systematic focus on requirements in industrial installations. MBI enclosure bases are designed with plane side walls. These can be mechanically processed according to customer requirements. Transparent covers are supplied with this version.

MBI enclosure bases are made of glass fibre reinforced polycarbonate in light grey colour RAL 7035. The material is UV-resistant (UL 746C F1) and self-extinguishing (UL 94 V0). The transparent covers are also made of UV-resistant polycarbonate (UL 746C F1) and comply with the flammability classification UL 94 V2. Depending on quantities, the enclosures can be produced in special colours.

With a seamlessly foamed 2-component polyurethane gasket, all types achieve protection class IP66. The cover screws are made of plastic material and therefore they are completely corrosion-free. The impact resistance of the enclosures corresponds to IK08, making the MBI series ideally suitable for use in industrial and outdoor applications.

MBI enclosures offer a variety of mounting points for direct fixation of components into the base. The self-forming plastic screws for assembly are included in the scope of delivery.

There are several ways to mount the enclosures to walls or machines. With the cover opened, mounting can be done through wall mounting channels outside the sealing area. Alternatively, there are pre-formed knockouts on the enclosure base. With the cover closed, the enclosures can be fastened with external wall brackets. Another option is mounting with M4 screws from the rear side into pressed-in thread bushes in the bottom of the enclosure.

Depending on quantities, we can produce customer-specific mould sides. Individual knockouts, cutouts and hole designs can be implemented in the injection mould and there is no requirement for further mechanical processing.

We would be glad to assist you!

### MULTI-BOX GmbH

Wallücker Bahndamm 7  
D-32278 Kirchlengern  
Tel. +49 (0)5223 49107-0

info@multi-box.com  
www.multi-box.com



| Dimensions and weight |     |
|-----------------------|-----|
| Length (mm)           | 65  |
| Width (mm)            | 65  |
| Height (mm)           | 81  |
| Weight (g)            | 155 |

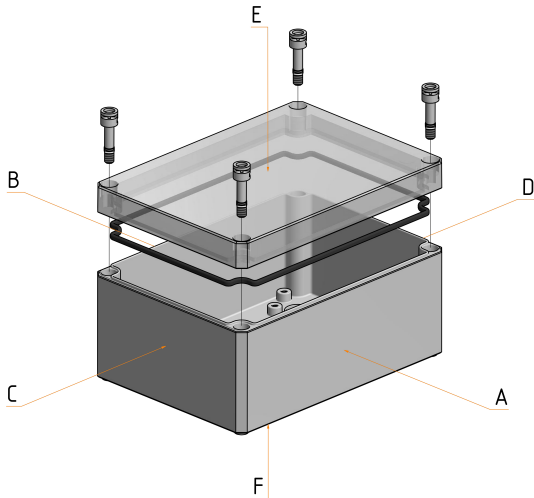

We would be glad to assist you!

**MULTI-BOX GmbH**

Wallücker Bahndamm 7  
D-32278 Kirchlegern  
Tel. +49 (0)5223 49107-0

info@multi-box.com  
www.multi-box.com

**Material information**

|                    |                    |
|--------------------|--------------------|
| Material cover     | Polycarbonate      |
| Material base      | Polycarbonate GF10 |
| Material sealing   | Polyurethane       |
| Material screws    | Plastic            |
| Silicone-free      | ✓                  |
| Halogen-free       | ✓                  |
| Material UL listed | ✓                  |
| UV-resistant       | ✓                  |

**Temperature resistance and application areas**

|   |     |
|---|-----|
| Permanent operating temperature max. (°C) | 100 |
| Permanent operating temperature min. (°C) | -40 |
| Suitable for outdoor use                  | ✓   |
| Suitable for indoor use                   | ✓   |

**Technical specifications**

|  |              |
|--|--------------|
| Protection class IP                      | 66           |
| Norm of protection class                 | DIN EN 60529 |
| Impact resistance IK                     | 08           |
| Norm of impact resistance                | EN 50102     |
| Flame retardancy                         | V-2          |
| UL-Subject                               | UL 94        |
| Fully insulated                          | ✓            |
| Sealing foamed seamless                  | ✓            |
| Captive cover screws                     | ✓            |
| Assembly tool                            | SL 5,5       |
| Tightening torque cover screws max. (Nm) | 1.4          |
| Tightening torque cover screws min. (Nm) | 1            |

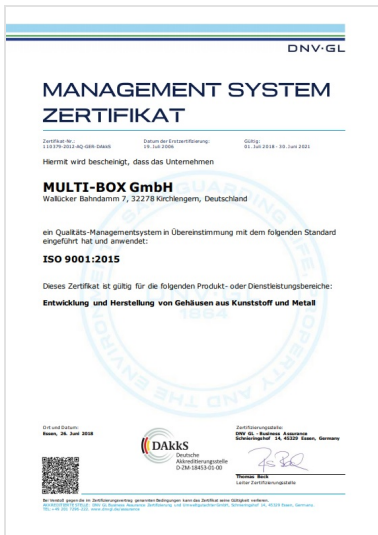









### Modifications and Services

- Mechanical processing ✔
- Finishing and Assembly ✔
- Surface design ✔
- Special colours ✔
- Special materials ✔

### Equipment and accessories

|   |                                |  |
|---|--------------------------------|--|
| Tragschiene TS 15<br>Article No. 0911100000               | Stahl verzinkt                 |  |
| Montageplatte Hartpapier<br>Article No. 0912107070        | Phenolharz Hartpapier          |       |
| Wandlaschen MBI (4 Stück)<br>Article No. 0313000032       | Polycarbonat GF10              |    |
| Wandmontagebuchsen M4 (4 Stück)<br>Article No. 1999000095 | Messing vernickelt / Edelstahl |  |





## INDIVIDUALITY IS OUR STANDARD

With our extensive machinery and a highly motivated team, we transform our standard products into your individual solution.

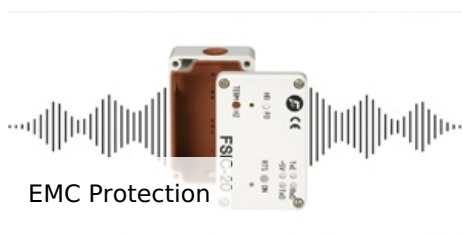

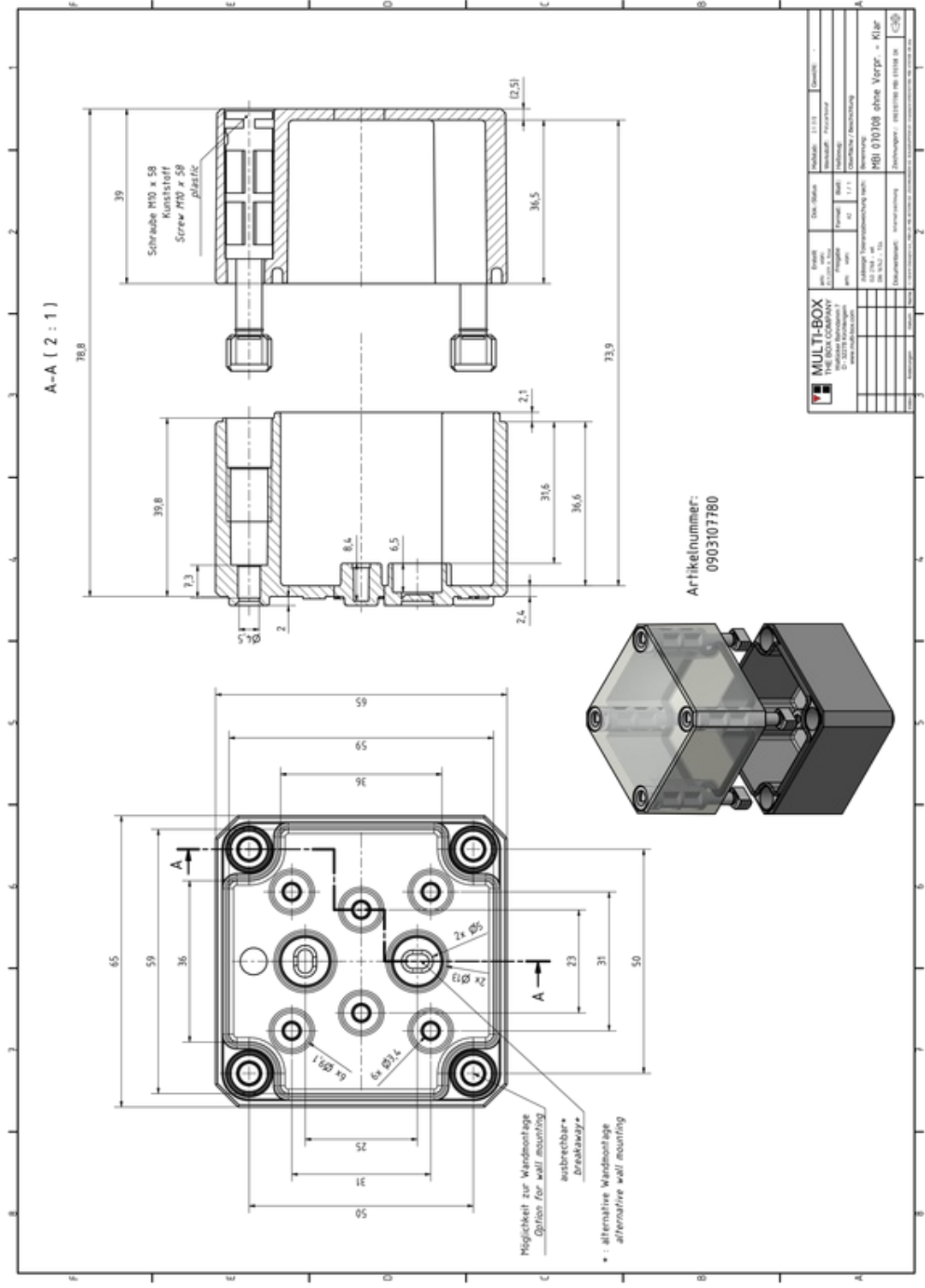

Under the following link you can download a higher resolution version of this drawing, including 3D construction data set:  
<https://www.multi-box.com/gehaeuse/enclosures/industrial-enclosures/plastic-enclosures/polycarbonate-pc-enclosures/mbi/ok/mbi-pc-070708-ok>