



MBI-PC BK 111107 O

Article No. 0905101170

Material: Polycarbonate GF10

Protection class: IP66

MBI BLACK - THE HIDDEN CHAMPION - Remarkably invisible.

MBI-BLACK industrial enclosures are the perfect combination of discreet presence, modern design and excellent technical performance.

Bases are designed with plane side walls. These can be mechanically processed according to customer requirements. Covers are supplied in black colour.

Their entirely black design integrates them seamlessly into industrial surroundings and enables a discreet, almost invisible installation in factory halls, control cabinets, camera systems or shaft installations. Thanks to their design in elegant black color and clean shapes MBI-BLACK enclosures have a modern appearance.

In addition, they reliably meet the high technical requirements of industrial installation technology. MBI BLACK enclosures are made of glass fibre reinforced polycarbonate. The material is UV-resistant (UL 746C F1) and self-extinguishing (UL 94 V0). With a seamlessly foamed 2-component polyurethane gasket, all types achieve protection class IP66. Cover screws are made of plastic material and therefore they are completely corrosion-free. The impact resistance corresponds to IK08, making the MBI BLACK enclosures ideally suitable for use in industrial and outdoor applications.

Depending on quantities, we can produce customer-specific mould sides. Individual knockouts, cutouts and hole designs can be implemented in the injection mould and there is no requirement for further mechanical processing.

MBI BLACK enclosures offer a variety of mounting points for direct fixation of components into the base. Self-tapping plastic screws for assembly are included in the scope of delivery.

We would be glad to assist you!

MULTI-BOX GmbH

Wallücker Bahndamm 7
D-32278 Kirchlengern
Tel. +49 (0)5223 49107-0

info@multi-box.com
www.multi-box.com



Dimensions and weight

Length (mm)	110
Width (mm)	110
Height (mm)	66
Weight (g)	235

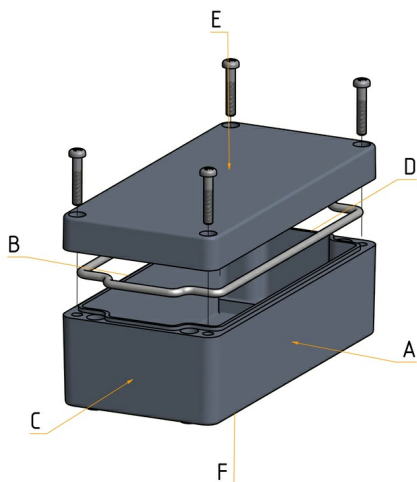

We would be glad to assist you!

MULTI-BOX GmbH

Wallücker Bahndamm 7
D-32278 Kirchlegern
Tel. +49 (0)5223 49107-0

info@multi-box.com
www.multi-box.com

Material information

Material cover	Polycarbonate GF10
Material base	Polycarbonate GF10
Material sealing	Polyurethane
Material screws	Plastic
Silicone-free	<input checked="" type="checkbox"/>
Halogen-free	<input checked="" type="checkbox"/>
Material UL listed	<input checked="" type="checkbox"/>
UV-resistant	<input checked="" type="checkbox"/>

Temperature resistance and application areas

Permanent operating temperature max. (°C)	100
Permanent operating temperature min. (°C)	-40
Suitable for outdoor use	<input checked="" type="checkbox"/>
Suitable for indoor use	<input checked="" type="checkbox"/>

Technical specifications

Protection class IP	66
Norm of protection class	DIN EN 60529
Impact resistance IK	08
Norm of impact resistance	EN 50102
Flame retardancy	V-0
UL-Subject	UL 94
Fully insulated	<input checked="" type="checkbox"/>
Sealing foamed seamless	<input checked="" type="checkbox"/>
Captive cover screws	<input checked="" type="checkbox"/>
Assembly tool	SL 5,5
Tightening torque cover screws max. (Nm)	1.4
Tightening torque cover screws min. (Nm)	1,0















Modifications and Services

- Mechanical processing ✔
- Finishing and Assembly ✔
- Surface design ✔
- Special colours ✔

Equipment and accessories

- | | | |
|---|---|--|
| <p>Mounting rail TS 35
Article No. 0911100004</p> | <p>Galvanized steel</p> | <p>  </p> |
| <p>Mounting plate phenolic resin hard paper
Article No. 0912211110</p> | <p>Phenolic resin hard paper</p> | <p>  </p> |
| <p>Wall mounting brackets MBI BK (4 pcs)
Article No. 0313000035</p> | <p>Polycarbonate GF10</p> | <p>  </p> |
| <p>Wall fixation bushes M4 (4 pcs)
Article No. 1999000095</p> | <p>Brass nickel-plated</p> | |
| <p>External Hinges MBI BK (2 pcs)
Article No. 0319000006</p> | <p>Polycarbonate GF10</p> | <p>  </p> |



INDIVIDUALITY IS OUR STANDARD

With our extensive machinery and a highly motivated team, we transform our standard products into your individual solution.

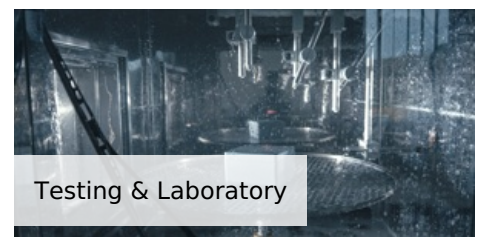
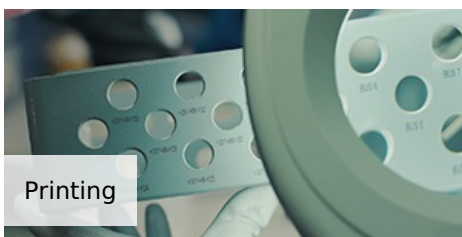

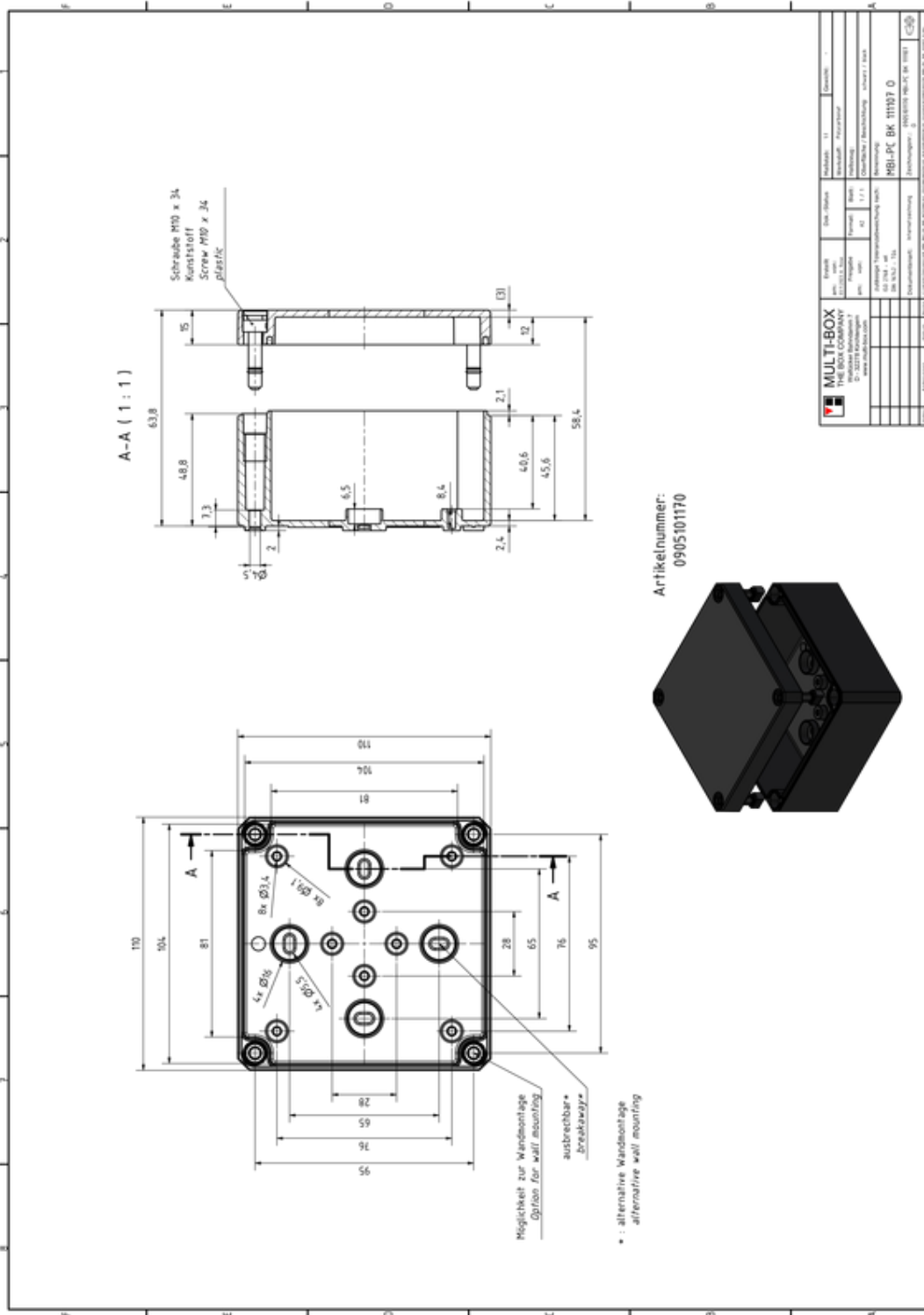

Under the following link you can download a higher resolution version of this drawing, including 3D construction data set:
<https://www.multi-box.com/en/enclosures/enclosures/industrial-enclosures/plastic-enclosures/polycarbonate-pc-enclosures/mbi/black/o/mbi-pc-bk-111107-o>