



## MBA-Ex empty 161080

Article No. 3111106500

Material: Aluminium

Protection class: IP66

MULTI-BOX **Aluminium-Ex empty enclosures** are conform to all installation field requirements where explosive concentrations of gases and dusts can appear. Zones 1 and 2 as well as 21 and 22.

MBA-Ex empty U certified enclosures have a component certificate confirming the construction security for the additional components to be added. Therefore the registration and re-testing of the new product, after the fitting of additional components is considerably simplified, due to the already approved enclosure construction.

The MBA-Ex empty enclosures have a U certification and therefore, after the installation of approved electrical and electrotechnical components into the enclosure, the complete unit should be retested with temperature characteristics included.

We would be glad to assist you!

### MULTI-BOX GmbH

Wallücker Bahndamm 7  
D-32278 Kirchlengern  
Tel. +49 (0)5223 49107-0

info@multi-box.com  
www.multi-box.com



### Dimensions and weight

Length (mm)	160
Width (mm)	100
Height (mm)	80

### Color information

Color description cover	Light Grey
RAL-code cover	7001
Color description base	Light Grey
RAL-code base	7001

### Technical Drawings

PDF	
DXF	
3D	



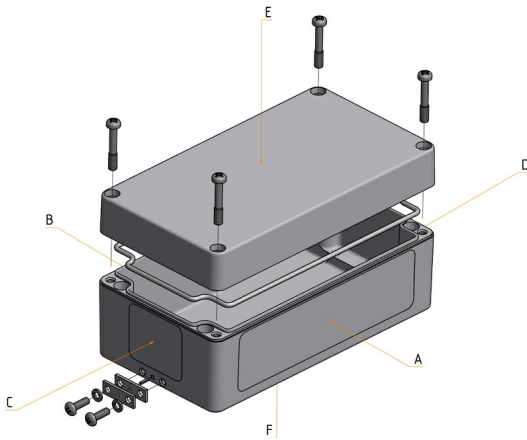

## Material information

Material cover	Aluminium
Material base	Aluminium
Material sealing	Silicone
Material screws	Stainless Steel V2 A
Halogen-free	<input checked="" type="checkbox"/>
UV-resistant	<input checked="" type="checkbox"/>
Surface coating	Powder coating

We would be glad to assist you!

### MULTI-BOX GmbH

Wallücker Bahndamm 7  
D-32278 Kirchlegern  
Tel. +49 (0)5223 49107-0

info@multi-box.com  
www.multi-box.com

## Temperature resistance and application areas

Permanent operating temperature max. (°C)	100
Permanent operating temperature min. (°C)	-55
Suitable for outdoor use	<input checked="" type="checkbox"/>
Suitable for indoor use	<input checked="" type="checkbox"/>





## Technical specifications

Protection class IP	66
Norm of protection class	DIN EN 60529
Earthing point available	<input checked="" type="checkbox"/>
Captive cover screws	<input checked="" type="checkbox"/>
Assembly tool	PZ2
Tightening torque cover screws max. (Nm)	3.00
Tightening torque cover screws min. (Nm)	1.50
Tightening torque earthing screw max. (Nm)	2.30
Tightening torque earthing screw min. (Nm)	1.20





## Details explosion protection













Categorisation	u
Zone classification	1, 2, 21, 22
Test report No. ATEX	IB-14-3-007
Test report No. IEC	IB-14-3-007
EC type-examination ATEX	IBExU10ATEX1158U
Certificate No. IEC	IECEX IBE 14.0020U
Marking	Ex II 2G Ex e IIC Gb, Ex II 2D Ex tb IIIC DI
Test norms	EN60079-0, EN60079-7, EN60079-31
Operating temperature max. (°C)	100
Operating temperature min. (°C)	-55
Surface temperature max. (°C)	135
Voltage max. (V)	1100
Current max. (A)	452
Cable cross section max. (mm <sup>2</sup> )	300
Protective conductor cross section max. (mm <sup>2</sup> )	150
External earthing point	
EC-Prototype Examination Certificate	
IEC-Certificate	
Declaration of Conformity	
Manufacturers Declaration	



## Modifications and Services

Mechanical processing	✓
Finishing and Assembly	✓
Surface design	✓
Special colours	✓

## Equipment and accessories

Tragschiene TS 15 Article No. 0111000655	Stahl verzinkt	
Tragschiene TS 35 Article No. 0111100655	Stahl verzinkt	  
Montageplatte Stahlblech Article No. 0112106500	Stahl verzinkt	  
Wandlaschen M4 (4 Stück) Article No. 0113100535	Edelstahl	  
Mastbefestigung MBFIX Article No. 0313000020	Edelstahl	  
Innensechskantschrauben Article No. 1980000115	Edelstahl	
Erdungsbolzen M6 Article No. 3000000169	Edelstahl	
Schutzleitersammelschiene Article No. 3000000002	Messing	





## INDIVIDUALITY IS OUR STANDARD

With our extensive machinery and a highly motivated team, we transform our standard products into your individual solution.

