



## MBP-Ex empty 402512

Article No. 3211101760

Material: Polyester GRP

Protection class: IP66

MULTI-BOX **MBP Polyester-Ex empty enclosures** are conform to all instillation field requirements where explosive concentrations of gases and dusts can appear. Zones 1 and 2 as well as 21 and 22.

MBP-Ex empty U certified enclosures have a component certificate confirming the construction security for the additional components to be added. Therefore the registration and re-testing of the new product, after the fitting of additional components is considerably simplified, due to the already approved enclosure construction.

The MBP Ex empty enclosures have a U certification and therefore, after the installation of approved electrical and electrotechnical components into the enclosure, the complete unit should be retested with temperature characteristics included.



We would be glad to assist you!

### MULTI-BOX GmbH

Wallücker Bahndamm 7  
D-32278 Kirchlengern  
Tel. +49 (0)5223 49107-0

info@multi-box.com  
www.multi-box.com

### Dimensions and weight

|             |     |
|-------------|-----|
| Length (mm) | 400 |
| Width (mm)  | 250 |
| Height (mm) | 120 |

### Color information

|                         |       |
|-------------------------|-------|
| Color description cover | Black |
| RAL-code cover          | 9005  |
| Color description base  | Black |
| RAL-code base           | 9005  |

### Technical Drawings

|     |  |
|-----|--|
| PDF |  |
| DXF |  |
| 3D  |  |



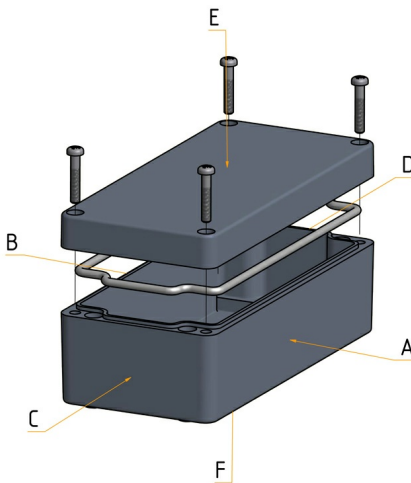

We would be glad to assist you!

**MULTI-BOX GmbH**

Wallücker Bahndamm 7  
D-32278 Kirchlengern  
Tel. +49 (0)5223 49107-0

info@multi-box.com  
www.multi-box.com

**Material information**

|                    |                      |
|--------------------|----------------------|
| Material cover     | Polyester GRP        |
| Material base      | Polyester GRP        |
| Material sealing   | Silicone             |
| Material screws    | Stainless Steel V2 A |
| Halogen-free       | ✓                    |
| Material UL listed | ✓                    |
| UV-resistant       | ✓                    |

**Temperature resistance and application areas**

|   |     |
|---|-----|
| Permanent operating temperature max. (°C) | 100 |
| Permanent operating temperature min. (°C) | -55 |
| Suitable for outdoor use                  | ✓   |
| Suitable for indoor use                   | ✓   |



**Technical specifications**

|  |              |
|--|--------------|
| Protection class IP                        | 66           |
| Norm of protection class                   | DIN EN 60529 |
| Flame retardancy                           | V0           |
| UL-Subject                                 | UL 94        |
| Fully insulated                            | ✓            |
| Captive cover screws                       | ✓            |
| Assembly tool                              | PZ2          |
| Tightening torque cover screws max. (Nm)   | 4.00         |
| Tightening torque cover screws min. (Nm)   | 2.00         |
| Tightening torque earthing screw max. (Nm) | 2.70         |
| Tightening torque earthing screw min. (Nm) | 1.50         |





## Details explosion protection





|  |   |
|--|---|
| Categorisation   | u   |
| Zone classification  | 1, 2, 21, 22  |
| Test report No. ATEX                                       | IB-13-3-094   |
| Test report No. IEC  | IB-13-3-094   |
| EC type-examination ATEX                                   | IBExU12ATEX1180U  |
| Certificate No. IEC  | IECEX IBE 14.0018U  |
| Marking  | Ex II 2G Ex e IIC Gb, Ex II 2D Ex tb IIIC DI  |
| Test norms   | EN60079-0, EN60079-7, EN60079-31  |
| Operating temperature max. (°C)                            | 100   |
| Operating temperature min. (°C)                            | -55   |
| Surface temperature max. (°C)                              | 100   |
| Voltage max. (V)   | 1100  |
| Current max. (A)   | 452   |
| Cable cross section max. (mm <sup>2</sup> )                | 300   |
| Protective conductor cross section max. (mm <sup>2</sup> ) | 150   |
| EC-Prototype Examination Certificate                       |  |
| IEC-Certificate  |  |
| Manufacturers Declaration                                  |  |



### Modifications and Services

- Mechanical processing ✔
- Finishing and Assembly ✔
- Surface design ✔

### Equipment and accessories

|   |                |   |
|---|----------------|---|
| Tragschiene TS 35<br>Article No. 0211101035         | Stahl verzinkt |    |
| Montageplatte Stahlblech<br>Article No. 0212101200  | Stahl verzinkt |    |
| Wandlaschen M6 (4 Stück)<br>Article No. 0113100520  | Edelstahl      |    |
| Erdungsbolzen M6<br>Article No. 3000000169          | Edelstahl      |   |
| Schutzleitersammelschiene<br>Article No. 3000000002 | Messing        |   |
| Schutzleiterhaltewinkel<br>Article No. 3006000018   | Edelstahl      |   |



## INDIVIDUALITY IS OUR STANDARD

With our extensive machinery and a highly motivated team, we transform our standard products into your individual solution.

