



MBP-Ex empty 404012

Article No. 3211101850

Material: Polyester GRP

Protection class: IP66

MULTI-BOX **MBP Polyester-Ex empty enclosures** are conform to all instillation field requirements where explosive concentrations of gases and dusts can appear. Zones 1 and 2 as well as 21 and 22.

MBP-Ex empty U certified enclosures have a component certificate confirming the construction security for the additional components to be added. Therefore the registration and re-testing of the new product, after the fitting of additional components is considerably simplified, due to the already approved enclosure construction.

The MBP Ex empty enclosures have a U certification and therefore, after the installation of approved electrical and electrotechnical components into the enclosure, the complete unit should be retested with temperature characteristics included.

We would be glad to assist you!

MULTI-BOX GmbH

Wallücker Bahndamm 7
D-32278 Kirchlengern
Tel. +49 (0)5223 49107-0

info@multi-box.com
www.multi-box.com



Dimensions and weight

Length (mm)	400
Width (mm)	405
Height (mm)	120

Color information

Color description cover	Black
RAL-code cover	9005
Color description base	Black
RAL-code base	9005

Technical Drawings

PDF	
DXF	
3D	



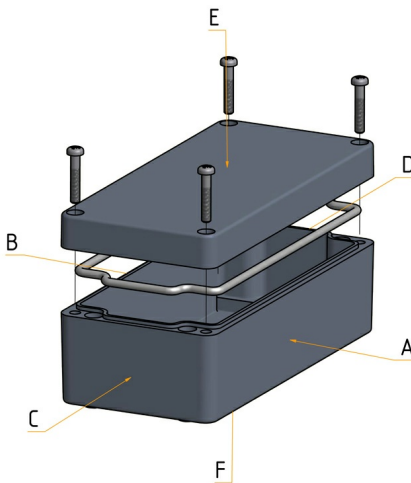

We would be glad to assist you!

MULTI-BOX GmbH

Wallücker Bahndamm 7
D-32278 Kirchlengern
Tel. +49 (0)5223 49107-0

info@multi-box.com
www.multi-box.com

Material information

Material cover	Polyester GRP
Material base	Polyester GRP
Material sealing	Silicone
Material screws	Stainless Steel V2 A
Halogen-free	✓
Material UL listed	✓
UV-resistant	✓

Temperature resistance and application areas

Permanent operating temperature max. (°C)	100
Permanent operating temperature min. (°C)	-55
Suitable for outdoor use	✓
Suitable for indoor use	✓



Technical specifications

Protection class IP	66
Norm of protection class	DIN EN 60529
Flame retardancy	V0
UL-Subject	UL 94
Fully insulated	✓
Captive cover screws	✓
Assembly tool	PZ2
Tightening torque cover screws max. (Nm)	4.00
Tightening torque cover screws min. (Nm)	2.00
Tightening torque earthing screw max. (Nm)	2.70
Tightening torque earthing screw min. (Nm)	1.50





Details explosion protection



Categorisation	u
Zone classification	1, 2, 21, 22
Test report No. ATEX	IB-13-3-094
Test report No. IEC	IB-13-3-094
EC type-examination ATEX	IBExU12ATEX1180U
Certificate No. IEC	IECEX IBE 14.0018U
Marking	Ex II 2G Ex e IIC Gb, Ex II 2D Ex tb IIIC DI
Test norms	EN60079-0, EN60079-7, EN60079-31
Operating temperature max. (°C)	100
Operating temperature min. (°C)	-55
Surface temperature max. (°C)	100
Voltage max. (V)	1100
Current max. (A)	452
Cable cross section max. (mm ²)	300
Protective conductor cross section max. (mm ²)	150
EC-Prototype Examination Certificate	
IEC-Certificate	
Manufacturers Declaration	



Modifications and Services

- Mechanical processing ✔
- Finishing and Assembly ✔
- Surface design ✔

Equipment and accessories

Tragschiene TS 35 Article No. 0211101035	Stahl verzinkt	  
Montageplatte Stahlblech Article No. 0212101300	Stahl verzinkt	  
Wandlaschen M6 (4 Stück) Article No. 0113100520	Edelstahl	  
Erdungsbolzen M6 Article No. 3000000169	Edelstahl	
Schutzleitersammelschiene Article No. 3000000002	Messing	
Schutzleiterhaltewinkel Article No. 3006000018	Edelstahl	



INDIVIDUALITY IS OUR STANDARD

With our extensive machinery and a highly motivated team, we transform our standard products into your individual solution.

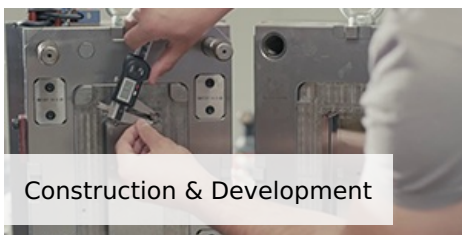
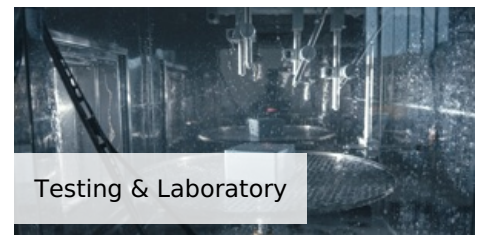

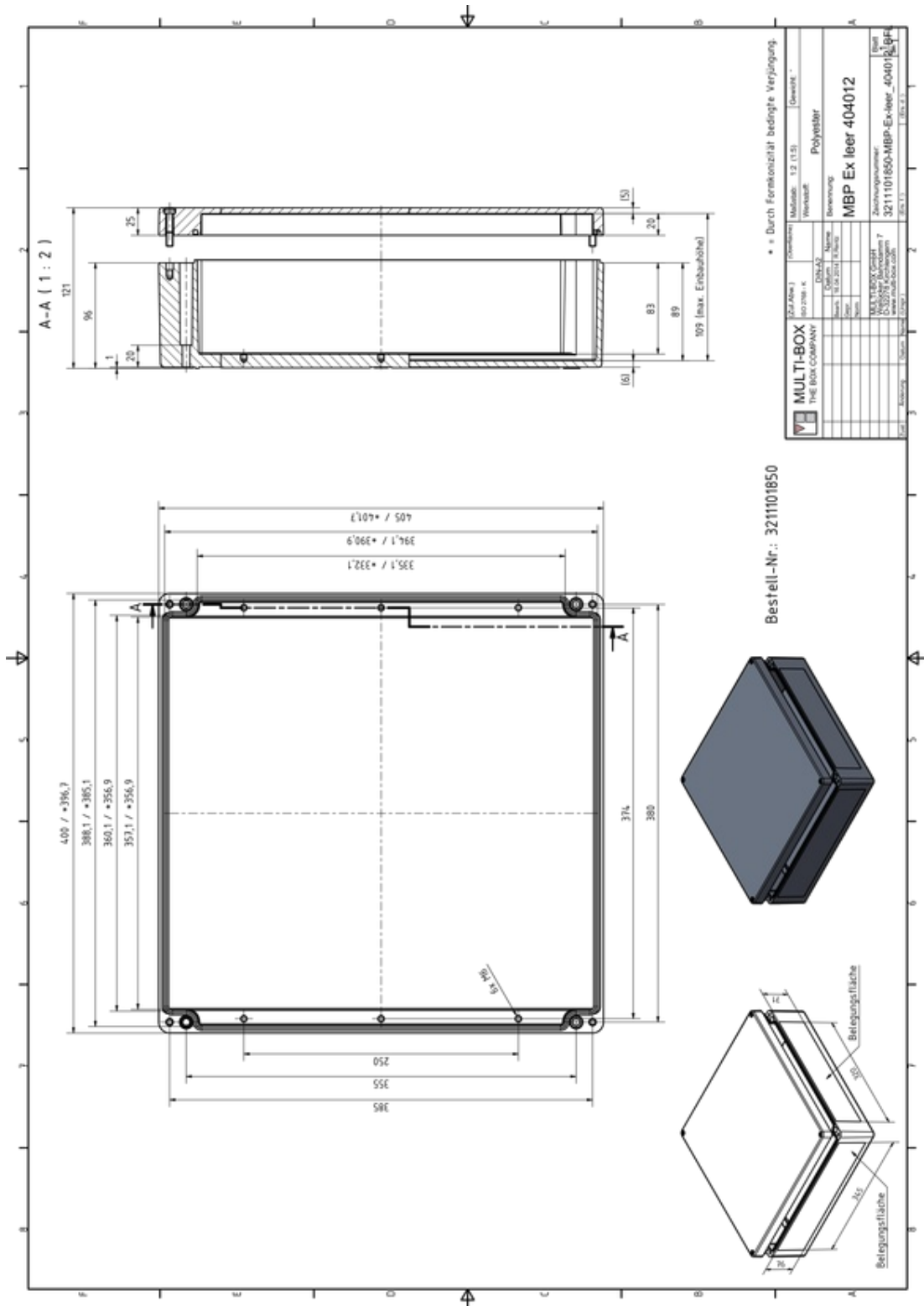

Under the following link you can download a higher resolution version of this drawing, including 3D construction data set:
<https://www.multi-box.com/gehaeuse/enclosures/ex-gehaeuse/polyester-ex-empty-enclosures/mbp-ex-empty-404012>