



GIOVENZANA

INTERNATIONAL B.V.



ENERGY & DATA TRANSMISSION SYSTEM
BUSBAR · MULTIPOLE · FESTOON



HANDLING · ENERGY & DATA TRANSMISSION SYSTEM

GIOVENZANA INTERNATIONAL B.V.



4/25	BUSBAR SYSTEM
6/7	Line construction Busbar System
8	Technical Data - Busbar & Multipole System

LINE TYPE / AMPERAGE COVERAGE

40A	50A	60A	70A	100A	140A	160A	200A	320A
-----	-----	-----	-----	------	------	------	------	------

TR60

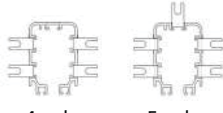
10/11	Continuous conductors Max 5 Poles	 Max 5 conductors slot	40A	60A
12/13	Pre-mounted conductors Max 5 Poles	 4 poles 5 poles	40A	60A

TR85H5P

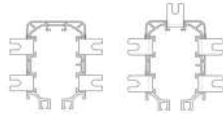
14/15	Continuous conductors Max 5 Poles	 Max 5 conductors slot	40A	70A	100A	140A
16/17	Pre-mounted conductors Max 5 Poles	 4 poles 5 poles	40A	70A	100A	140A

TR85H7P

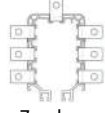
18/19	Continuous conductors Max 7 Poles	 Max 7 conductors slot	50A	100A	160A	200A*	320A*
20/21	Pre-mounted conductors Max 7 Poles	 7 poles	50A	100A	160A	200A*	320A*

*Only 4 poles with parallel connections

22/23	Accessories Busbar System
24/25	Survey Busbar System

26/29 **MULTIPOLE SYSTEM**

LINE TYPE / AMPERAGE COVERAGE

40A	50A	60A	70A	100A	140A	160A	200A	320A
-----	-----	-----	-----	------	------	------	------	------

MPO4P

28/29 Pre-Mounted Conductors
4 Poles

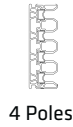

4 Poles

60A

100A

140A

30/41 **FESTOON SYSTEM**

32 Line construction Festoon System

LINE 30

34/35 Standard



LINE 41

36/37 Standard

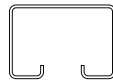

36/37 Stainless Steel

LINE WIRE-ROP

38 Standard



LINE I-BEAM

39 Light Series



40 Flat cables - Festoon System

41 Round cables with dual strain relief cords - Festoon System



BUSBAR SYSTEM

The “trolley system” series conductors rails is modern and safe system for energy transmission for various types of equipment, such as, cranes, bridge cranes, conveyour belts, chain conveyors, etc...

The “trolley system” complies with the relevant international standards ensuring safety of the operator, easy installation and reliability.



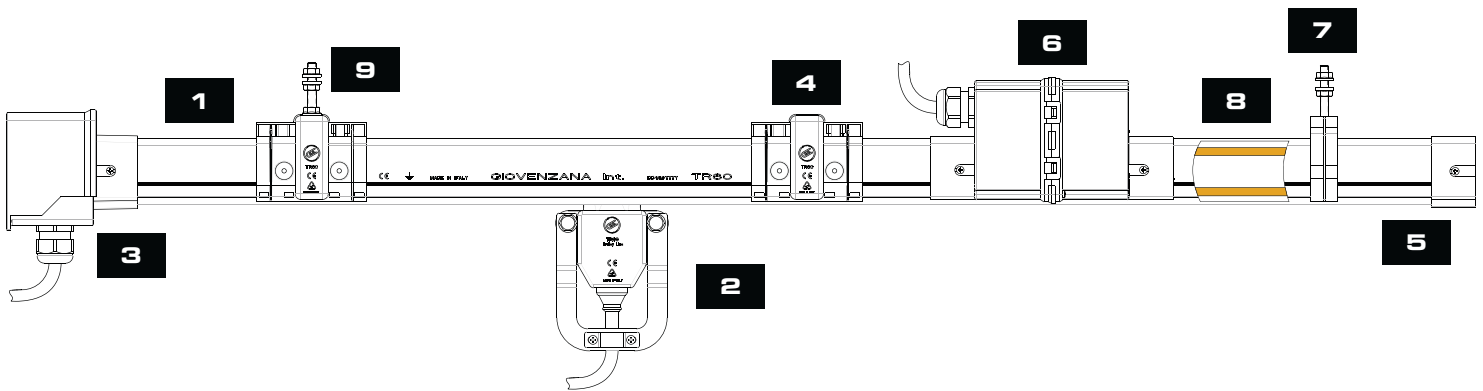

The new “H” honeycomb profile of the TR85H line guarantees extra endurance and lightness.

TYPICAL LAYOUT

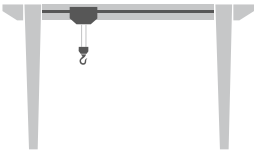
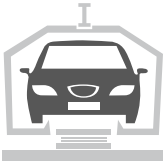
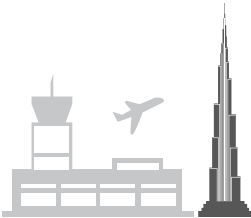
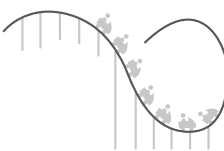
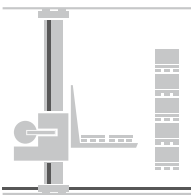

1	BUSBAR	PVC Housing
2	TROLLEY CURRENT COLLECTOR	Transmits the energy from the conductor to the machine
3	HEAD FEED BOX	Connects power supply to the conductors
4	JOINT BOX	Links two busbars
5	END CAP	Closes and protects the busbar end
6	IN-LINE FEED BOX	Connects power supply from centre to avoid the voltage drop
7	HANGER CLAMP	Connects the busbar to the brackets
8	COPPER STRIP	Transmits the energy from the power supply to the current collector
9	FIXED POINT	Creates a fixed point

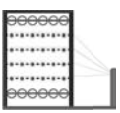
TYPICAL UTILIZATIONS

 CRANE TECHNOLOGY Cranes and Hoists Recycling plants Galvanized plants	 PRODUCTION AUTOMATION Electric systems Automated conveyors	 BMU Building Maintenance Units Airport and terminal stations Skyscrapers Cleanroom technology	 PEOPLE MOVER SYSTEM People movers Vertical elevators Inclined elevators	 STORAGE High-bay warehouses Automated storage	 AGRICULTURE  TEXTILE  AIRCRAFT HANGAR DOORS
---	--	---	---	---	---

AVAILABLE VERSIONS

A. CONTINUOUS CONDUCTORS

The conductors are pulled from a coil without joints into the already installed casing.

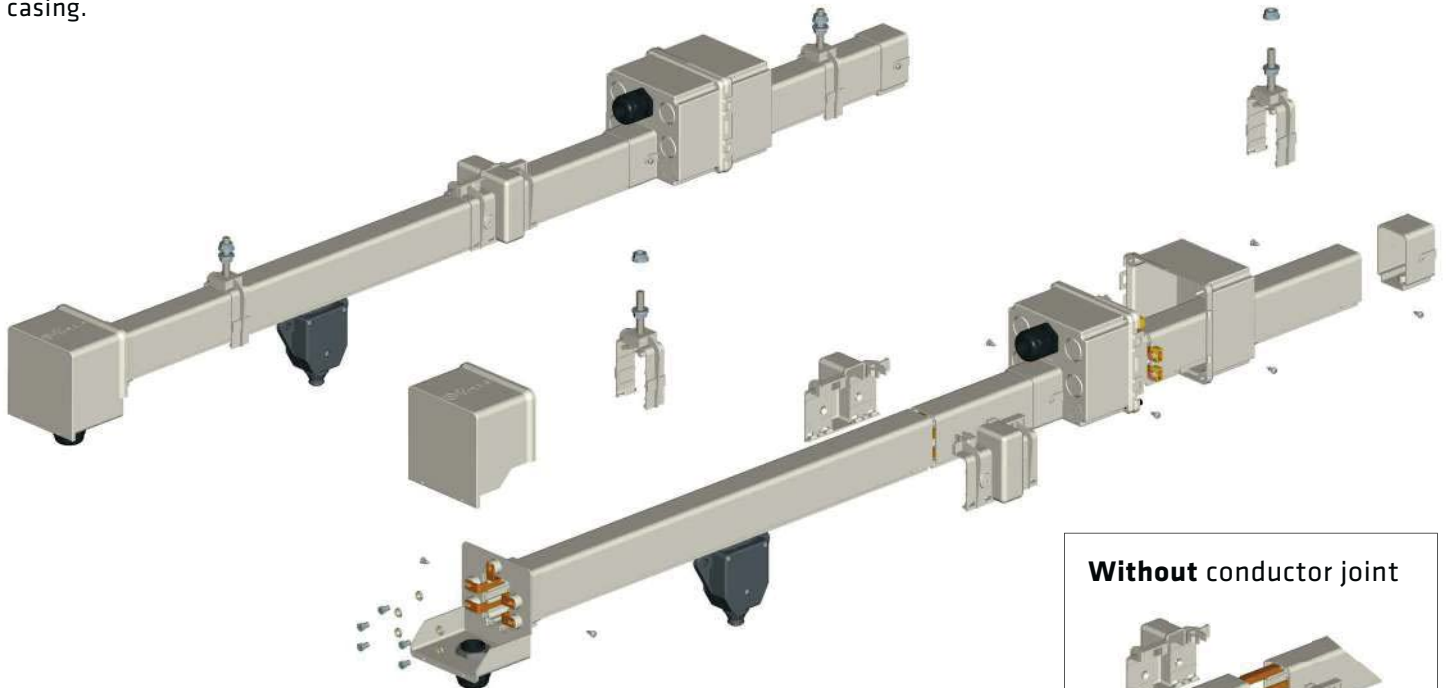

Without conductor joint

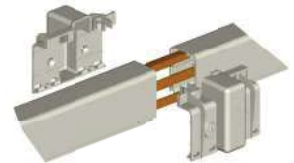

B. PRE-MOUNTED CONDUCTORS

The conductors are already inserted in the plastic casing.

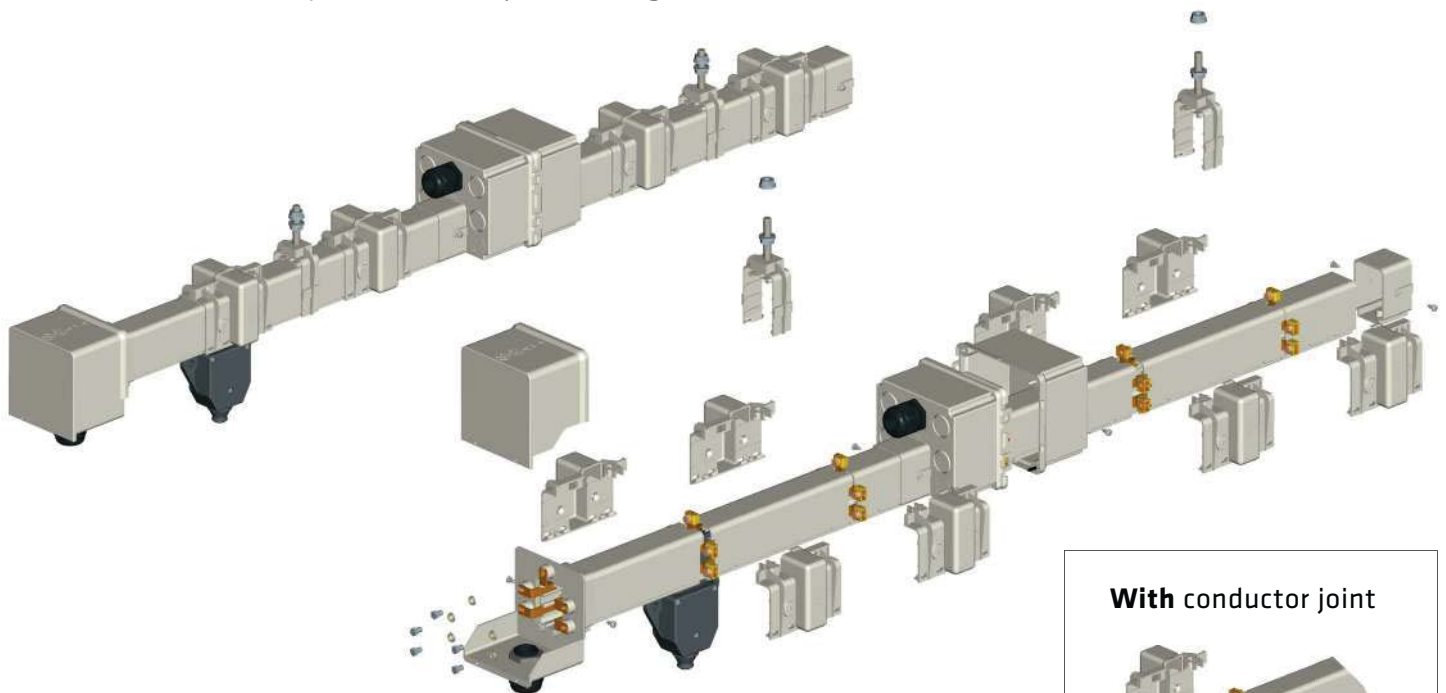

With conductor joint



LINE CONSTRUCTION

To decide the size of trolleys it is necessary to consider:

- Maximum current in service
- Devices (cage motors, slip rings motors, resistors, electronic starters)
- Starting current of the devices
- Maximum ambient temperature
- The distance between device to the nearest power feed
- Voltage and admissible voltage drop in continuous and in starting service
- Type of current
- Devices cycle operations (load factor)

CALCULATION OF THE VOLTAGE DROP

➤ Voltage drop should not exceed 5% of rated voltage in normal operating service.

Three phase alternate current:

$$\Delta u = \sqrt{3} \times I \times L_t \times Z$$

$$\Delta u\% = \frac{\Delta u \times 100}{U}$$

Keys:

- Δu = Voltage drop [V]
- $\Delta u\%$ = Voltage drop [%]
- I = Current intensity [A]
- L_t = Length of section [m]
- Z = Impedence [Ω/m]
- U = Voltage [V]

POWER FEED: BUSBAR TRACK LENGHT

➤ A proper disposal of power feed points minimize the voltage reduction.
If "L" is the lenght of the line, "Lt" is the track maximum length to consider the voltage reduction.

- A** $L_t = L$ - with ending/starting power feed
- B** $L_t = L/2$ - with in-line power feed
- C** $L_t = L/6$ - with power feed at 1/6 from each end
- D** $L_t = L/10$ - with three power feed at L/2 and L/10 from each end

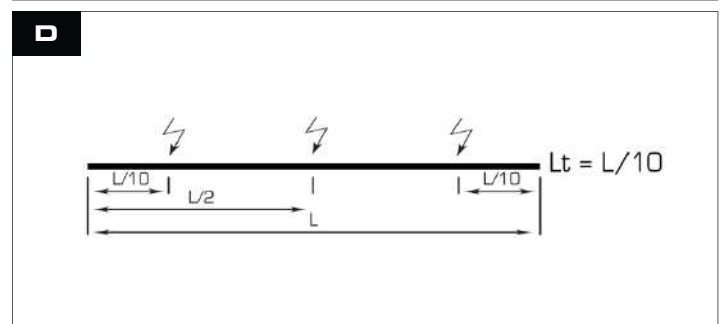
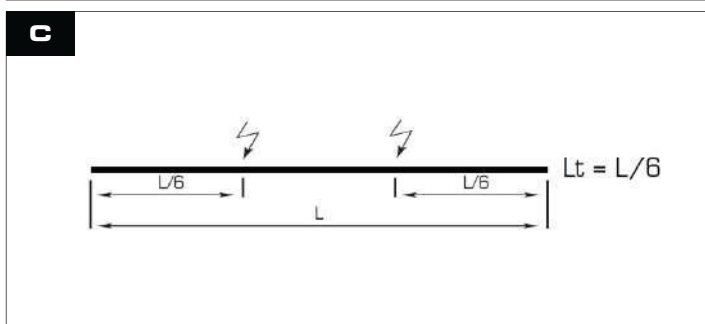
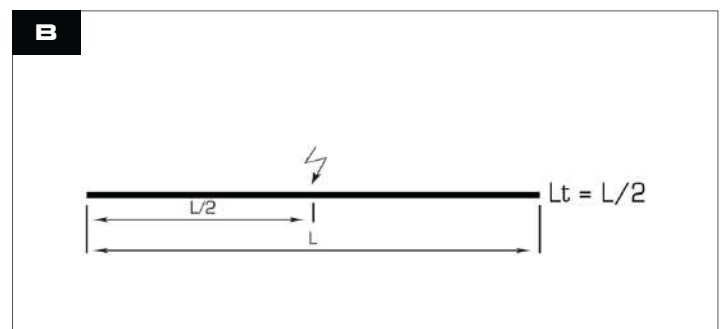
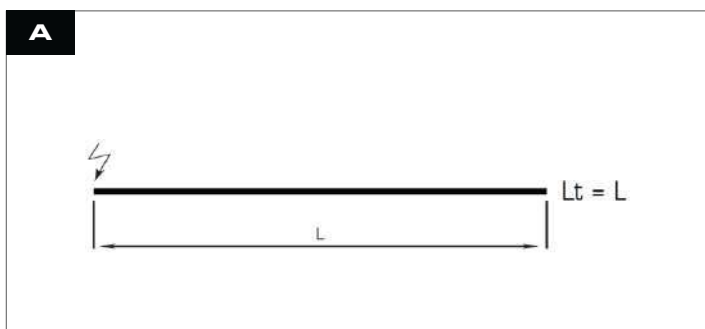

CURRENT IN CONTINUOUS SERVICE

Specify the number of the devices which work simultaneously to calculate the corresponding current:

$$I_n = I_1 + I_2 + I_3 + \dots$$

The current can be determined from the devices power [W] that for a three phase system is:

$$I_n = \frac{P_u}{\sqrt{3} \times U \times \cos\varphi \times \eta}$$

Keys:

I_n = Current consumption [A]

P_u = Power devices [W]

η = Devices performance

U = Operating Voltage [V]

$\cos\varphi$ = Power factor

In the absence of information on the operation of simultaneous devices, consider the following table:

N° OF IN-LINE LIFTING DEVICE	LIFTING EQUIPMENT IN USE			
	1 ST ENGINE	2 ND ENGINE	3 TH ENGINE	4 TH ENGINE
	max power engine*		decreasing power engine*	
1	x	x		
2	x	x	x	
3	x	x	x	
4	x	x	x	x
5	x	x	x	x
N° 2 lifting equipment operating simultaneously	x	x	x	x

* About η motors connected in parallel with rated current I_n' , consider $I_n = \eta \times I_n'$.

STARTING CURRENT

Calculate the numbers of the devices started simultaneously and the device already in service, then calculate the corresponding current. If the starting current is unknown, proceed with the following approximation:

For a single user

$$I_a = K \times I_n \quad K = \frac{\text{Starting current (I}_a\text{)}}{\text{Nominal current (I}_n\text{)}}$$

As a general rule, consider:

$K = 5$ to 6 for cage motors

$K = 2$ for winding motors

$K = 2$ for inverters (frequency converters)

In the absence of information on the operation of simultaneous devices, consider the following table:

N° OF IN-LINE LIFTING DEVICE	LIFTING EQUIPMENT IN USE							
	1 ST ENGINE		2 ND ENGINE		3 TH ENGINE		4 TH ENGINE	
	I_a	I_n	I_a	I_n	I_a	I_n	I_a	I_n
1	x			x				
2	x			x		x		
3	x		x					
4	x		x			x		
5	x		x			x		x
N° 2 lifting equipment operating simultaneously	x		x			x		x



GENERAL CHARACTERISTICS

LINE / SIZE	TR60		TR85H5P				TR85H7P			MPO4P		
	40	60	40	70	100	140	50	100 200*	160 320*	60	100	140
Operating current 23°C	40A	60A	40A	70A	100A	140A	50A	100A	160A	60A	100A	140A
Comply with standards	CEI EN 60439-1, CEI EN 60439-2, CEI EN 60695-2-1, CEI EN 60570											
Markings	C E EAC											
Rated operating voltage [Ue]	600Vac											
Frequency	50Hz											
Conditional short circuit withstand current	10 ka											
Fuse rating gG	40A	60A	40A	70A	100A	140A	50A	100A	160A	60A	100A	140A
Protection class CEI EN 60529	IP13 (IP44 with gasket accessories)									IP20		
Flammability resistance:												
UL94	V0											
CeI EN 60695-2-1	960°C											
Ambient Temperature												
operating	-30°C +55°C											
storage	-30°C +70°C											
Max admissible trolley speed	200 m/min ⁻¹									400 m/min ⁻¹		
ETP Copper strip section [mm ²]	10 10x1	15 10x1,5	9,3 15,5x0,6	15,5 15,5x1	23,25 15,5x1,5	31 15,5x2	10 12,5x0,8	22,5 12,5x1,8	31,25 12,5x2,5	15	24	32
Resistance [Ω /m 10 ⁻⁴]	17	11,33	18,27	10,96	7,83	5,48	17	8,38	5,29	11,33	7,83	5,48
Impedence [Ω /m 10 ⁻⁴]	17,09	11,38	18,36	11,01	7,87	5,55	17,09	8,42	5,36	11,38	7,87	5,55

* The 200A and the 320A are obtained by parallel configuration, so only for 4 poles. The values indicated are referred to the single conductor.









CONDUCTORS BARS WEIGHT TABLE (complete of conductors)

LINE / SIZE	TR60		TR85H5P				TR85H7P			MPO4P		
	40	60	40	70	100	140	50	100	160	60	100	140
Weight [kg/m] +/- 50g												
4 poles	1,05	1,25	1,40	1,65	1,95	2,25	-	-	-	1,25	1,54	1,83
5 poles	1,15	1,35	1,50	1,80	2,15	2,55	-	-	-	-	-	-
7 poles	-	-	-	-	-	-	1,70	2,30	3,05	-	-	-





PVC BUSBAR CHARACTERISTICS

MATERIAL	CERTIFICATIONS	RIGID PVC
Self-extinguish	UL94 DIN 4102 D.M. 6/7/83	V0 B2 CI
Ultimate tensile strenght	ISO R527 23°C	430 kg/cm ³
Yield point	ISO R527 23°C	460 kg/cm ³
Modulus of elasticity	ISO R178 23°C	30.000 kg/cm ³
Impact resistance	DIN 53453	Unbroken
Dielectric strenght	ASTM 149	25 kv/mm
Softening temperature - Vicat	ISO R306 49N	82°C



ITEM	PRODUCT	SPECIFICATION	40A	60A
BUSBAR		<ul style="list-style-type: none"> - Standard length: 4 meters*. - Material: PVC. 	TR6000W	
CONDUCTOR SIZE		ETP Copper	CS40 10x1 - 10mm ²	CS60 10x1,5 - 15mm ²
JOINT BOX		<ul style="list-style-type: none"> - Material: Plastic. - To connect two busbars. 	TR6001W	
HANGER CLAMP		<ul style="list-style-type: none"> - Material: Plastic. - Max support spacing: 1,33 m. 	TR6002W	
		<ul style="list-style-type: none"> - Material: Steel. - Max support spacing: 1,33 m. 	TR6020	
END CAP		<ul style="list-style-type: none"> - Material: Plastic. - Closes and protects the busbar end. 	TR6006W	
FEED BOX		<ul style="list-style-type: none"> - Material: Plastic. - To use to feed the line (at the head of the line). 	TR6003W	
IN-LINE FEED		<ul style="list-style-type: none"> - To use along the line in order to prevent voltage drop. - Clamps or screws + nuts not included. 	TR6008W Recommended use of dedicated accessories to page 23.	
TROLLEY CURRENT COLLECTOR (for straight and curved lines)		25A - 4 Conductors	TR6004	
		25A - 5 Conductors	TR6005	









TR60
Continuous Conductors

ITEM	PRODUCT	SPECIFICATION	40A	60A
TOWING ARM		- To use to move the trolley current collector.		TR8557
TOWING ARM BRACKET		- Alternative product of TR8557 (with TR8510).		TR6007
TOWING ARM		- To use with TR6007 or TR6013.		TR8510
DOUBLE TROLLEY SUPPORT		- For utilization with two trolleys in order to have ampacity of 50A.		TR6013
FIXED POINT		- Fix the line to control thermal expansion. - One for each line.		TR6014W
TRANSFER GUIDE				TR6034
SPRING LOADED TOWING ARM		- For transfer guide.		TR8538 Coming soon
GASKET IP44				TR6012
CONDUCTOR INSERTION TROLLEY		- For insertion of copper conductor in the line.		TR6011
DE-COIL UNIT				TR8513















ITEM	PRODUCT	SPECIFICATION	40A	60A
BUSBAR		- Standard length: 4 meters*. - 4 Conductors.	TR60404CW	TR60604CW
		- Standard length: 4 meters*. - 5 Conductors.	TR60405CW	TR60605CW
		- Conductor type.	Included in busbar code 10x1 - 10mm ²	Included in busbar code 10x1,5 - 15mm ²
JOINT BOX		- Material: Plastic. - To connect two busbars.	TR6001W	
HANGER CLAMP		- Material: Plastic. - Max support spacing: 1,33 m.	TR6002W	
		- Material: Steel. - Max support spacing: 1,33 m.	TR6020	
END CAP		- Material: Plastic. - Closes and protects the busbar end.	TR6006W	
FEED BOX		- 4 Conductors.	TR6003A4W	
		- 5 Conductors.	TR6003A5W	
IN-LINE FEED		- 4 Conductors.	TR6008A4W	
		- 5 Conductors.	TR6008A5W	
TROLLEY CURRENT COLLECTOR		- 25A - 4 Conductors.	TR6004	
		- 25A - 5 Conductors	TR6005	

TR60
Pre-Mounted Conductors













ITEM	PRODUCT	SPECIFICATION	40A	60A
TOWING ARM		- To use to move the trolley current collector.		TR8557
TOWING ARM BRACKET		- Alternative product of TR8557 (with TR8510).		TR6007
TOWING ARM		- To use with TR6007 or TR6013.		TR8510
DOUBLE TROLLEY SUPPORT		- For utilization with two trolleys in order to have ampacity of 50A.		TR6013
FIXED POINT		- To fix the line to control thermal expansion. - 1 for each line.		TR6014W
TRANSFER GUIDE		- LEFT - 4 Conductors.		TR6034A4W
		- LEFT - 5 Conductors.		TR6034A5W
		- RIGHT - 4 Conductors.		TR6035A4W
		- RIGHT - 5 Conductors.		TR6035A5W
SPRING LOADED TOWING ARM		- For transfer guide.		TR8538 Coming soon
GASKET IP44				TR6012













ITEM	PRODUCT	SPECIFICATION	40A	70A	100A	140A
BUSBAR		- Standard length: 4 meters*. - Material: PVC.	TR85H5PW			
CONDUCTOR SIZE		- ETP Copper.	RM40 15,5x0,6 9,3mm ²	RM70 15,5x1 15,5mm ²	RM100 15,5x1,5 23,25mm ²	RM140 15,5x2 31mm ²
JOINT BOX		- Material: Plastic. - To connect two busbars.	TR8501W			
		- Material: Steel. - To connect two busbars.	TR8524			
HANGER CLAMP		- Material: Plastic. - Max support spacing: 1,33 m.	TR8502W			
		- Material: Steel. - Max support spacing: 1,33 m.	TR8525			
END CAP		- Material: Plastic. - Closes and protects the busbar end.	TR8506W			
FEED BOX		- Material: Plastic. - To use to feed the line (at the head of the line).	TR8503W			
IN-LINE FEED		- To use along the line in order to prevent voltage drop - Clamps or screws + nuts not included.	TR8547W Recommended use of dedicated accessories to page 23.			
TROLLEY CURRENT COLLECTOR		- 35A - 4 Conductors.	TR8511			
		- 35A - 5 Conductors.	TR8512			
		- 70A - 4 Conductors.	TR8518			
		- 70A - 5 Conductors.	TR8519			
TROLLEY CURRENT COLLECTOR FOR CURVES		- 35A - 4 Conductors.	TR8516			
		- 70A - 4 Conductors.	TR8532			

TR85H5P

Continuous Conductors





ITEM	PRODUCT	SPECIFICATION	40A	70A	100A	140A
TOWING ARM		- To use to move the trolley current collector.				TR8557
TOWING ARM BRACKET		- Alternative product of TR8557 (with TR8510).				TR6007
TOWING ARM		- To use with TR6007 or TR8523.				TR8510
DOUBLE TROLLEY SUPPORT		- For utilization with two trolleys in order to have ampacity of 140A.				TR8523
FIXED POINT		- To fix the line to control thermal expansion - 1 for each line.				TR8527.1
EXPANSION JOINT		- To use to compensate thermal expansion.				TR85H5P07W
INSPECTION JOINT		- To use to extract the trolley from the line (when there are more than two trolleys).				TR85H5P28W
SECTION JOINT		- To use to section the line (double up the number of the trolleys).				TR85H5P45W
TRANSFER GUIDE						TR85H5P34
SPRING LOADED TOWING ARM		- For transfer guide.				TR8538 Coming soon
GASKET IP44						TR8505
CONDUCTOR INSERTION TROLLEY		- For insertion of copper conductor in the line.				TR8514
DE-COIL UNIT						TR8513

















ITEM	PRODUCT	SPECIFICATION	40A	70A	100A	140A
BUSBAR		- Standard length: 4 meters*. - 4 Conductors.	TR85H5P404CW	TR85H5P704CW	TR85H5P1004CW	TR85H5P1404CW
		- Standard length: 4 meters*. - 5 Conductors.	TR85H5P405CW	TR85H5P705CW	TR85H5P1005CW	TR85H5P1405CW
		- Conductor Type.	Included in Busbar code			
			15,5x0,6 9,3mm ²	15,5x1 15,5mm ²	15,5x1,5 23,25mm ²	15,5x2 31mm ²
JOINT BOX		- Material: Plastic. - To connect two busbars.	TR8535W			
HANGER CLAMP		- Material: Plastic. - Max support spacing: 1,33 m.	TR8502W			
		- Material: Steel. - Max support spacing: 1,33 m.	TR8525			
END CAP		- Material: Plastic. - Closes and protects the busbar end	TR8506W			
FEED BOX		- 4 Conductors.	TR85H5P03A4W			
		- 5 Conductors.	TR85H5P03A5W			
IN-LINE FEED		- To use along the line in order to prevent voltage drop.	TR8547W			
TROLLEY CURRENT COLLECTOR		- 35A - 4 Conductors.	TR8511			
		- 35A - 5 Conductors.	TR8512			
		- 70A - 4 Conductors.	TR8518			
		- 70A - 5 Conductors.	TR8519			
TROLLEY CURRENT COLLECTOR FOR CURVES		- 35A - 4 Conductors.	TR8516			
			- 70A - 4 Conductors.	TR8532		

TR85H5P

Pre-Mounted Conductors

ITEM	PRODUCT	SPECIFICATION	40A	70A	100A	140A
TOWING ARM		- To use to move the trolley current collector.				TR8557
TOWING ARM BRACKET		- Alternative product of TR8557 (with TR8510).				TR6007
TOWING ARM		- To use with TR6007 or TR8523.				TR8510
DOUBLE TROLLEY SUPPORT		- For utilization with two trolleys in order to have ampacity of 140A.				TR8523
FIXED POINT		- To fix the line to control thermal expansion. - 1 for each line.				TR8527.1
SECTION JOINT		- To use to section the line (double up the number of the trolleys).				TR85H5P45W
TRANSFER GUIDE		- LEFT - 4 Conductors.				TR85H5P34A4W
		- LEFT - 5 Conductors.				TR85H5P34A5W
		- RIGHT - 4 Conductors.				TR85H5P35A4W
		- RIGHT - 5 Conductors.				TR85H5P35A5W
SPRING LOADED TOWING ARM		- For transfer guide.				TR8538 Coming soon
GASKET IP44						TR8505

ITEM	PRODUCT	SPECIFICATION	50A	100/200A*	160/320A*
BUSBAR		- Standard length: 4 meters.	TR85H7PW		
CONDUCTOR SIZE		- ETP Copper.	CSH750 12,5x0,8 10mm ²	CSH7100 12,5x1,8 22,5mm ²	CSH7160 12,5x2,5 31,25mm ²
JOINT BOX		- Material: Plastic. - To connect two busbars.	TR8501W		
		- Material: Steel. - To connect two busbars.	TR8524		
HANGER CLAMP		- Material: Plastic. - Max support spacing: 1 m.	TR8502W		
		- Material: Steel. - Max support spacing: 1 m.	TR8525		
END CAP		- Material: Plastic. - Closes and protects the busbar end.	TR8506W		
FEED BOX		- Only for 7 poles till 100A.	TR85H7P005W	-	
IN-LINE FEED		- Clamps or screws + nuts not included.	TR85H7P03W Recommended use of dedicated accessories to page 23.		
TRANSITION BOX		- For parallel connections 200A or 320A.	-	TR8564 Coming soon	
FIXED POINT		- To fix the line to control thermal expansion. - 1 for each line.	TR85271		
TROLLEY CURRENT COLLECTOR FOR CURVES		- 35A - Single.	TR85H7P001		
		- 70A - Double.	TR85H7P002		
		- 105A - Triple.	TR85H7P010		

TR85H7P

Continuous Conductors











ITEM	PRODUCT	SPECIFICATION	50A	100/200A*	160/320A*
TOWING ARM		- Single.			TR8557
		- Double.			TR8558
		- Triple.			TR8559
4 POLES TROLLEY CONNECTION CLAMP		- Single (3ph 70A - PE 35A).			TR8561
		- Double (3ph 140A - PE 70A).			TR8562
		- Triple (3ph 210A - PE 105A).			
EXPANSION JOINT		- To use to compensate thermal expansion.			TR85H7P07W
INSPECTION JOINT		- To use to extract the trolley from the line (when there are more than two trolleys).			TR85H7P28W
SECTION JOINT		- To use to section the line (double up the number of the trolleys).			TR85H7P45W
TRANSFER GUIDE					TR85H7P34
SPRING LOADED TOWING ARM		- For transfer guide.			TR8538 Coming soon
GASKET IP44					TR8505
CONDUCTOR INSERTION TROLLEY		- For insertion of copper conductor in the line.			TR85H7P14
DE-COIL UNIT					TR8513

* The 200A and the 320A are obtained by parallel configuration ONLY for 4 poles.

ITEM	PRODUCT	SPECIFICATION	50A	100A	160A	200A*	320A*	
BUSBAR		- Standard length: 4 meters*. - 4 Conductors.	-	-	-	TR85H7P1007CW	TR85H7P1607CW	
		- Standard length: 4 meters. - 7 Conductors.	TR85H7P507CW	TR85H7P1007CW	TR85H7P1607CW	-	-	
		- Conductor Type.	Included in busbar code					
			12,5x0,8 10mm ²	12,5x1,8 22,5mm ²	12,5x2,5 31,25mm ²	2X (12,5x1,8) 2x22,5mm ²	2X (12,5x2,5) 2x31,25mm ²	
JOINT BOX		- Material: Plastic. - To connect two busbars.	TR85H7P007W					
HANGER CLAMP		- Material: Plastic. - Max support spacing: 1 m.	TR8502W					
		- Material: Steel. - Max support spacing: 1 m.	TR8525					
END CAP		- Material: Plastic. - Closes and protects the busbar end.	TR8506W					
FEED BOX		- 7 Conductors.	TR85H7P005A7W					
IN-LINE FEED		- 7 Conductors.	TR85H7P03A7W					
TRANSITION BOX		- For parallel connections 200A or 320A.	-				TR8564 Coming soon	
FIXED POINT		- To fix the line to control thermal expansion. - 1 for each line.	TR8527.1					
TROLLEY CURRENT COLLECTOR FOR CURVES		- 35A - Single.	TR85H7P001					
		- 70A - Double.	TR85H7P002					
		- 105A - Triple.	TR85H7P010					





TR85H7P

Pre-Mounted Conductors



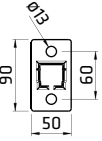
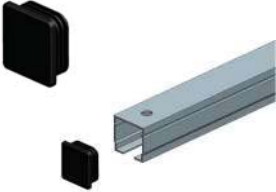
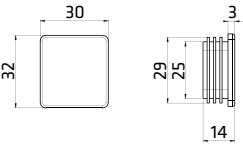

ITEM	PRODUCT	SPECIFICATION	50A	100A	160A	200A*	320A*
TOWING ARM		- Single.					TR8557
		- Double.					TR8558
		- Triple.					TR8559
4 POLES TROLLEY CONNECTION CLAMP		- Single (3ph 70A - PE 35A).					TR8561
		- Double (3ph 140A - PE 70A).					TR8562
		- Triple (3ph 210A - PE 105A).					
SECTION JOINT		- To use to section the line (double up the number of the trolleys).					TR85H7P45W
TRANSFER GUIDE		- LEFT - 7 Conductors.					TR85H7P34A7W
		- RIGHT - 7 Conductors.					TR85H7P35A7W
SPRING LOADED TOWING ARM		- For transfer guide.					TR8538 Coming soon
GASKET IP44							TR8505

* The 200A and the 320A are obtained by parallel configuration ONLY for 4 poles.

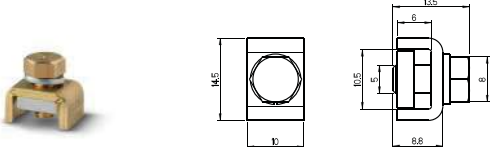
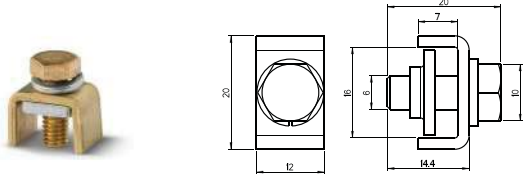
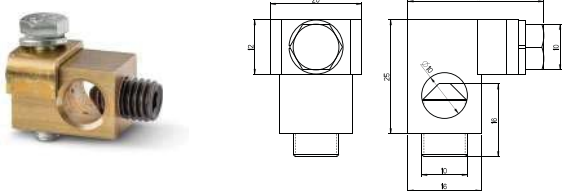

ITEM	PRODUCT	SPECIFICATION	CODE
<p>SUPPORT BRACKET (RAIL Fixing)</p>	  <p>2 arm clips kit included. THK ≤ 10mm</p> <p>Mounting Example</p> 	L=350mm	TR8550
	L=500mm	TR8551	
	L=700mm	TR8552	
<p>SUPPORT BRACKET (Wall Fixing)</p>	  <p>Wall drilling plan</p> 	L=350mm	TR8555
	L=500mm	TR8556	
<p>END CAP</p>	 		30607015

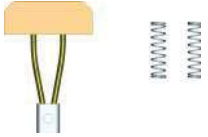
**BUSBAR
ACCESSORIES**

ITEM	PRODUCT	SPECIFICATION	CODE
<p>TR60 CONDUCTORS CONNECTION CLAMP</p>		<p>Brass material</p>	<p>TR6015</p>
<p>TR85H5P CONDUCTORS CONNECTION CLAMP</p>		<p>Brass material</p>	<p>TR8548</p>
<p>TR85H5P CONDUCTORS CONNECTION CLAMP (for IN-LINE FEED)</p>		<p>Brass material</p>	<p>TR8537</p>
<p>TR85H7P CONDUCTORS CONNECTION KIT</p>		<p>Flanged screw M6x12</p>	<p>11606075</p>
<p>TR85H7P CONDUCTORS CONNECTION KIT</p>		<p>Flanged nut M6</p>	<p>11612013</p>
<p>TR85H5P BRUSH KIT REPLACEMENT</p>		<p>Only for: TR8518, TR8519, TR8532. One piece for each pole.</p>	<p>TR8520K</p>
<p>TR85H7P BRUSH KIT REPLACEMENT</p>		<p>1x TR85H7P001 2x TR85H7P002 3x TR85H7P010</p>	<p>TR85H7P020K</p>
<p>TR85H7P WHEELS KIT REPLACEMENT</p>		<p>Only for: TR85H7P001 TR85H7P002 TR85H7P010</p>	<p>TR85H7P021K</p>



COMPANY NAME: CITY:

COUNTRY: CONTACT:

PHONE: MAIL:

DATE: REFERENCE:

1 GENERAL DATA

1.1 TYPE OF INDUSTRY Crane BMU Storage Other

1.2 N° MACHINE FOR TRACK

1.3 N° OF TRACKS

1.4 TRACK LENGHT m

1.5 TRACK LAYOUT mt straight - mt curved

(Please include Layout Drawing on the next page)

2 ELECTRICAL DATA

2.1 POWER / CURRENT PER MACHINE Kw - Inom A - Istart A

2.2 MAX SIMULTANEOUS CURRENT PER TRACK A

2.3 POWER SUPPLY VOLTAGE V 50/60 Hz - n° phases PE N

2.4 CONTROL SIGNALS Specify number - Voltage

2.5 SWITCH FREQUENCY AND DUTY CYCLE OF THE MACHINERY per - duty cycle 50% 60% 70% 80% 90% 100%

3 SYSTEM CONFIGURATION

3.1 FEED POINT(S) At beginning - At mt from beginning - At mt from each end

3.2 CENTRE DISTANCE HANGERS mt

4 MACHINE PARAMETERS

4.1 TRAVEL SPEED m/min

4.2 BUILD DIMENSIONS Please list if there are any build dimensions to take in consideration (include drawing)

5 ENVIRONMENTAL DATA

5.1 INDOOR OR OUTDOOR Indoor outdoor

5.2 MIN & MAX AMBIENT TEMP. °C min °C max

5.3 ENVIRONMENTAL DETAILS Normal Dusty Humid Corrosive Other

6 OPTIONS

6.1 TRANSFER GUIDES Yes No Quantity

6.2 SECTION JOINT Yes No Specify the position in the line

6.3 IP44 RUBBER GASKET Yes No

6.3 OTHER

1.5 LAYOUT DRAWING



MULTIPOLE SYSTEM

The Multipole System is one of the most used insulated system for transmission of power. The main applications of this system are for mobile power consumer: automatic warehouse, light cranes and packaging machinery. The honeycomb profile guarantees high rigidity and the design of the trolley allow to feed device that have high travel speed (up to 500 m/min).

TYPICAL LAYOUT

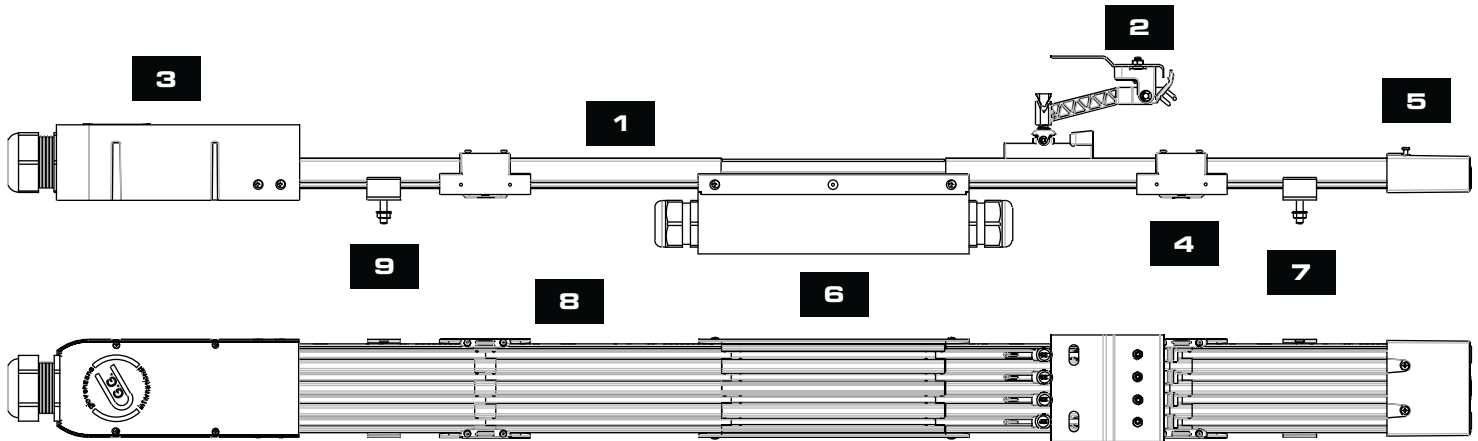

1	BUSBAR	PVC Housing
2	TROLLEY CURRENT COLLECTOR	Transmits the energy from the conductor to the machinery
3	HEAD FEED BOX	Connects power supply to the conductors
4	JOINT BOX	Links two busbars
5	END CAP	Closes and protects the busbar end
6	IN-LINE FEED BOX	Connects power supply from centre to the conductors
7	HANGER CLAMP	Connects the busbar to the support (posts, columns)
8	COPPER STRIP	Transmits the energy from the power supply to the current collector
9	FIXED POINT	Creates a fixed point to control thermal expansion

TYPICAL UTILIZATIONS

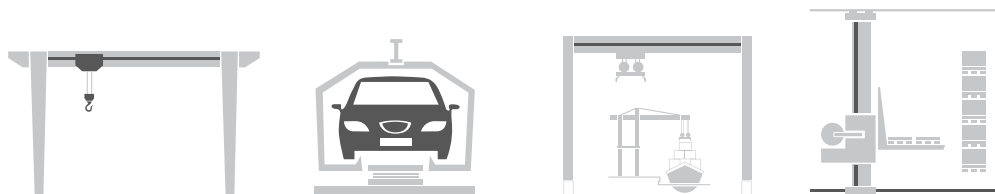

CRANE TECHNOLOGY

Cranes and Hoists
Recycling plants
Galvanized plants

PRODUCTION AUTOMATION

Electric systems
Automated conveyors

PORT TECHNOLOGY

RTG cranes
STG cranes

STORAGE

High-bay warehouses
Automated storage

MULTIPOLE SYSTEM





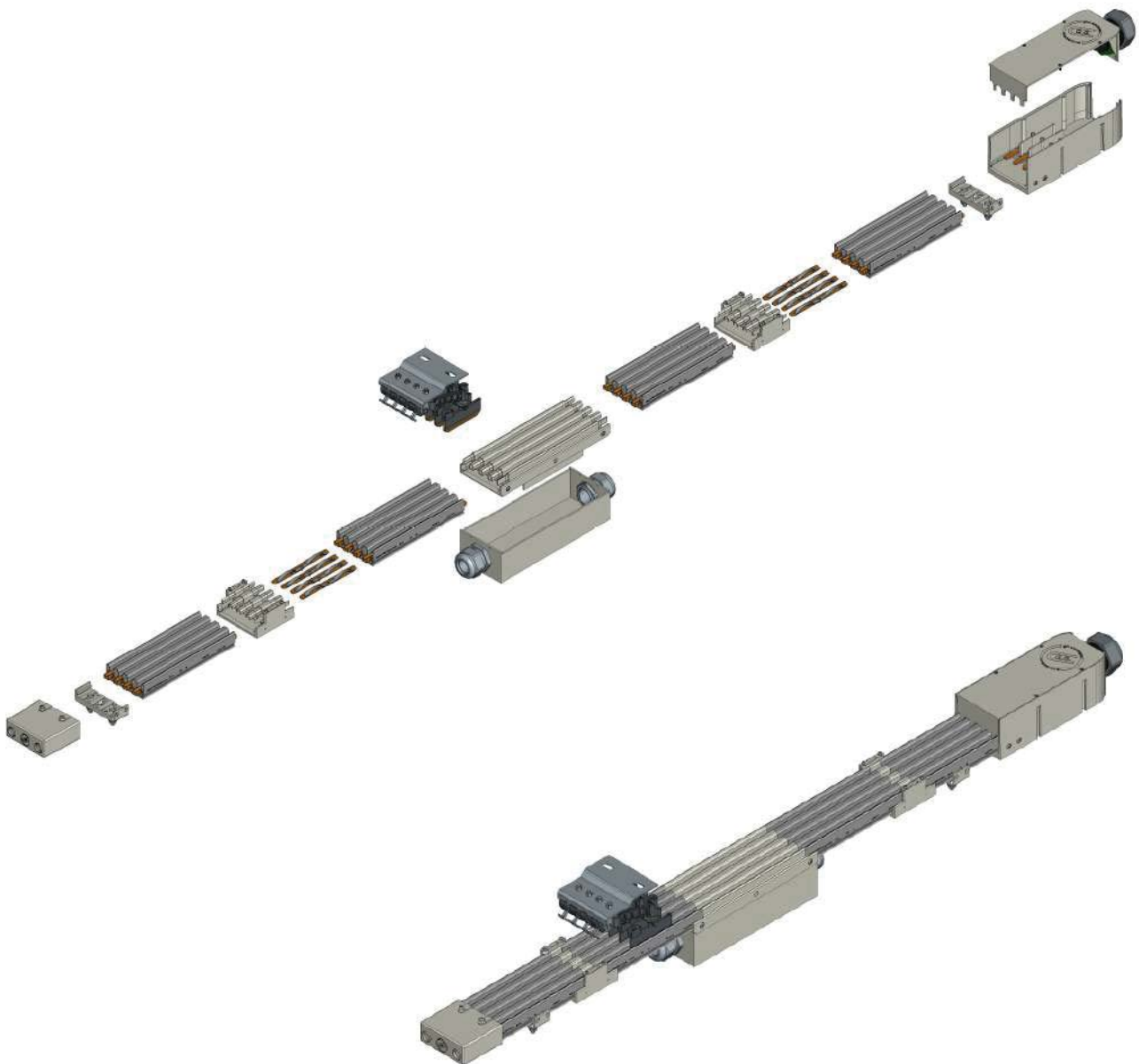

AVAILABLE VERSION

PRE-MOUNTED CONDUCTORS

The conductors are already inserted in the plastic casing.





ITEM	PRODUCT	SPECIFICATION	60A	100A	140A
BUSBAR		<ul style="list-style-type: none"> - PVC busbar; - Copper ETP; - Length 4 mt; - 4 Poles. 	MP04P060	MP04P100	MP04P140
JOINT UNIT		<ul style="list-style-type: none"> - Material: PA + copper; - To use to connect two busbar. 		MP04P001	
HANGER CLIP		<ul style="list-style-type: none"> - Material: PA; - 1 or 2 screws to fix; - 1 piece each 1 mt. 		MP04P002	
FIX POINT		<ul style="list-style-type: none"> - Material: PA; - 1 or 2 screws to fix; - 1 piece each 1 line. 		MP04P014	
END CAP		<ul style="list-style-type: none"> - Material: PA; - To use at the end of the line. 		MP04P006	
HEAD FEED		<ul style="list-style-type: none"> - Material: PA; - To use to feed the line (at the end or at the head). 		MP04P003	
IN-LINE FEED				MP04P008	

MULTIPOLE SYSTEM

ITEM	PRODUCT	SPECIFICATION	60A	100A	140A
<p>TROLLEY CURRENT COLLECTOR</p>		<ul style="list-style-type: none"> - 50A. - COMPACT. - Max deflection: +-15mm- 	MP04P011		
		<ul style="list-style-type: none"> - 50A. - LONG. - Max deflection: +-30 mm. 	MP04P012		
<p>DOUBLE TROLLEY CURRENT COLLECTOR</p>		<ul style="list-style-type: none"> - 100A. - COMPACT. - Max deflection +-15mm. 	MP04P021		
		<ul style="list-style-type: none"> - 100A. - LONG. - Max deflection: +-30 mm. 	MP04P022		



FESTOON SYSTEM

The Festoon System is the traditional system for energy transmission by using cable. The main applications of this system is for mobile power consumer like crane, monorail, electric hoist, machine tools, car wash systems, plating lines, etc...

This feeding system has several advantages:

- Safety - the cable are flame resistant, the conductor are completely protected;
- Versatility - it can be used for straight rail as curves rail, for indoor and outdoor applications;
- Easy to install;
- The maintenance of the line is extremely reduced.

AVAILABLE VERSIONS

A. LINE 30

- **LOAD CAPACITY: 100 kg/m**
- **Bar size: 30 x 32 mm**
- **Bar lenght: 4 mt**

B. LINE 41

- **LOAD CAPACITY: 140 kg/m**
- **Bar size: 39 x 56 mm**
- **Bar lenght: 4 mt**

C. LINE 41 STAINLESS STEEL

- **LOAD CAPACITY: 140 kg/m**
- **Bar size: 39 x 56 mm**
- **Bar lenght: 3 mt**

D. LINE WIRE-ROPE

- **TROLLEY LOAD CAPACITY: 8 kg**
- **Rope diameter: 8 mm**
- **Travel speed: 40 m/min**

E. LINE I-BEAM Light Series

- **TROLLEY LOAD CAPACITY: 50 kg**
- **I-beam type: IPE-IPN 80÷100**
- **Travel speed: 120 kg/m**
- **Max cable capacity: 70 mm**

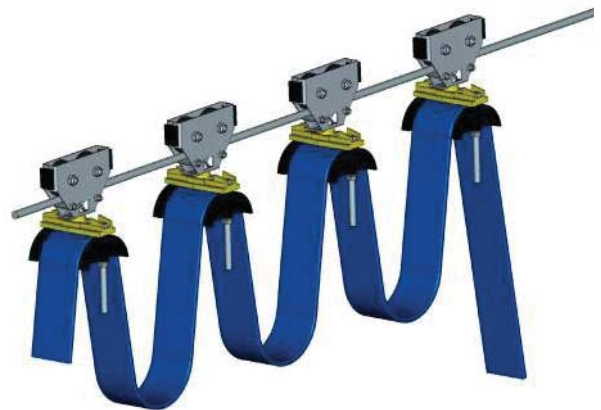

TYPICAL LAYOUT

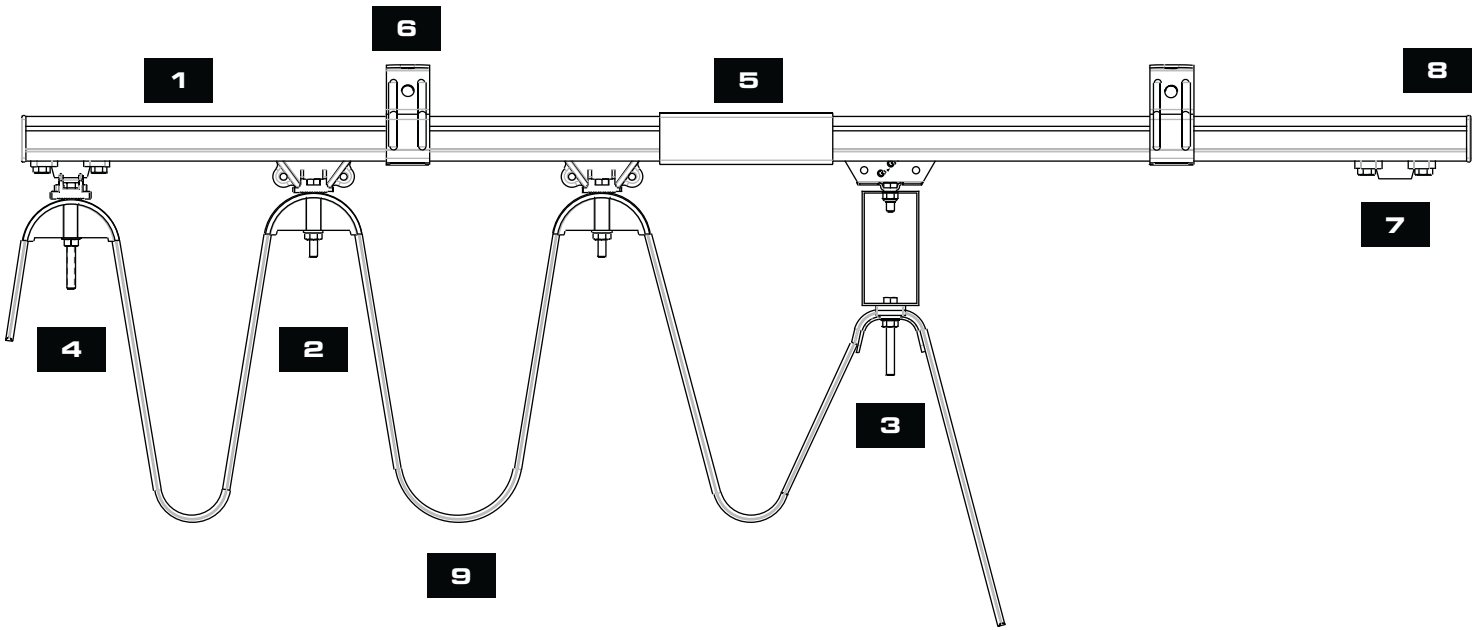

1	C-RAIL BAR	Steel material
2	TROLLEY	Supports the cable
3	TOWING TROLLEY	Connects to the mobile device and allows the movement
4	HEAD CLAMP	Cable-supporting element without movement
5	JOINT	Connects two C-rail bars
6	SUPPORT	Holds the C-rail bar
7	END STOP	Prevents the exit of the trolley from the C-rail bar
8	END CAP	Closes and protects the C-rail bar
9	CABLE	Transmits the energy

TYPICAL UTILIZATIONS



CRANE TECHNOLOGY

Cranes and Hoists
Recycling plants
Galvanized plants

PRODUCTION AUTOMATION

Electric systems
Automated conveyors

BMU

Building Maintenance Units
Airport and terminal stations
Skyscrapers
Cleanroom technology

PORT TECHNOLOGY

RTG cranes
STG cranes

STORAGE

High-bay warehouses
Automated storage



LINE DIAGRAMS



**LINE 30 / 41 /
41 Stainless Steel**



LINE WIRE-ROPE



LINE I-BEAM

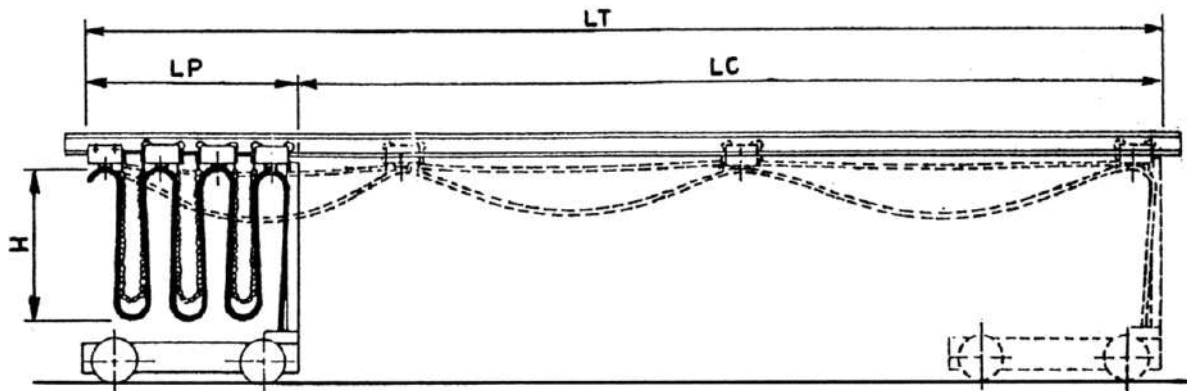

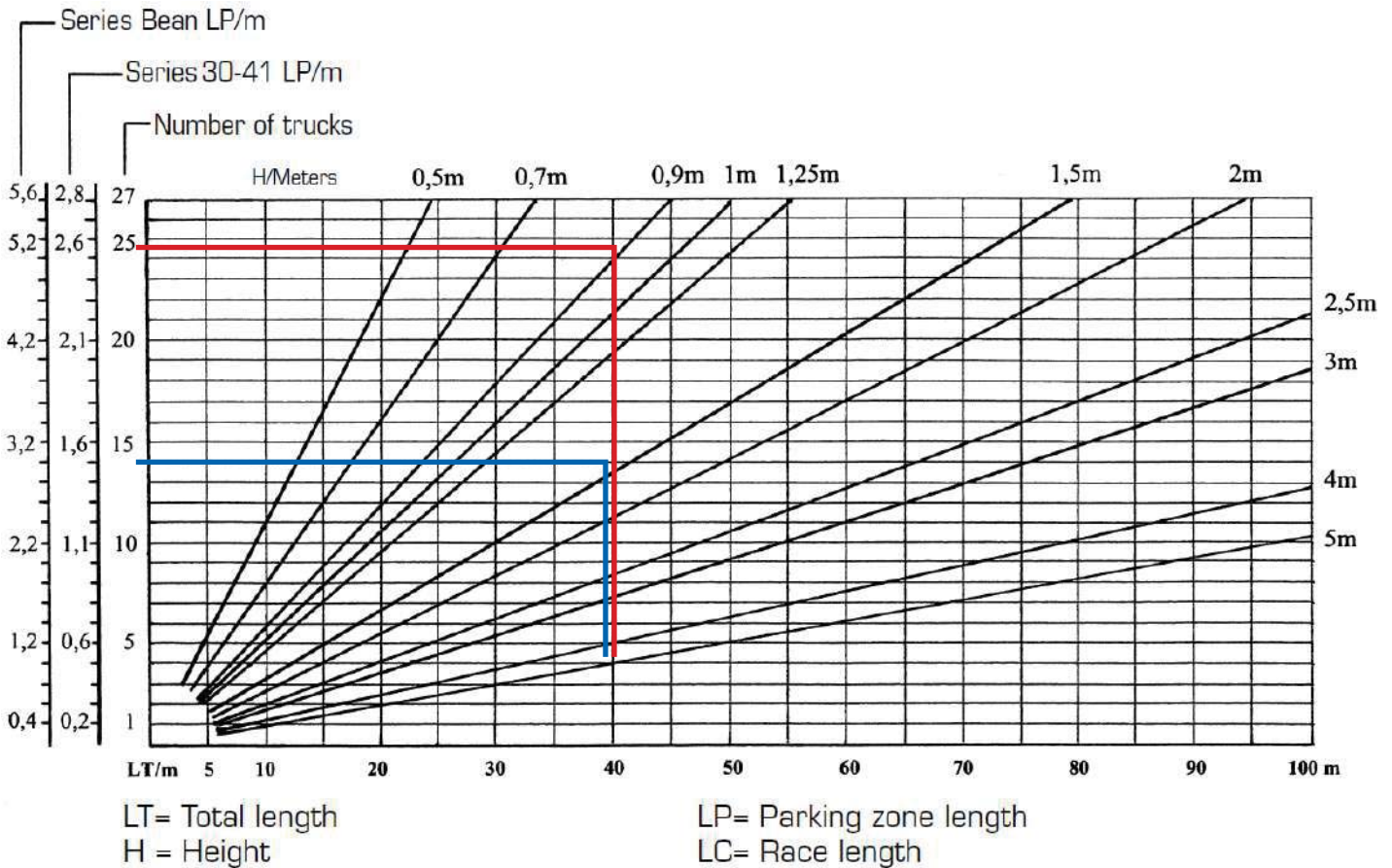

BLUE Example









Total line length "LT" = 40 mt
Height "H" = 2 mt
Number of trolley/trucks = 12 pcs
Parking zone length "LP" = 1,2 meters
Race length "LC=LT-LP" = 38,8 meters





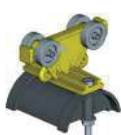

RED Example

Total line length "LT" = 40 meters
Height "H" = 1 meters
Number of trolley/trucks = 21 pcs
Parking zone length "LP" = 2,2 meters
Race length "LC=LT-LP" = 37,8 meters



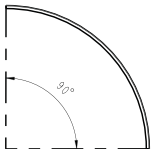

The diagram is used to determine the number of trolley necessary for the formation of the line, depending on its length.

The height of the loop determines how many trolley are needed and thus their parking area. Where the parking area is too long at the expense of running real user, it must increase the height of the loops, thus decreasing the number of trolleys required and therefore the parking area. To determine the cable length of a garland to increase by 10% the total length of the line and add enough to connect the two ends of the fixed and mobile users.





ITEM	PRODUCT	SPECIFICATION	LINE 30
C-RAIL BAR		<ul style="list-style-type: none"> - Material: steel. - Length: 4 mt. - Max load capacity: 100 kg/m. 	30607001
JOINT		<ul style="list-style-type: none"> - To connect 2 C-Rail bars. 	30607002
TRACK SUPPORT BRACKET		<ul style="list-style-type: none"> - Max support spacing: 1 mt. 	30607003
		<ul style="list-style-type: none"> - Ceiling fixing. - Max support spacing: 1 mt. 	30607017
SUPPORT ARM BRACKET		<ul style="list-style-type: none"> - Bracket fixing. - Max support spacing: 1 mt. 	30607004
BRACKET		<ul style="list-style-type: none"> - Length: 0,5 mt. 	30607001/050F
		<ul style="list-style-type: none"> - Length: 0,8 mt. 	30607001/080F
SUPPORT ARM CLIPS		<ul style="list-style-type: none"> - To fix bracket to I-beam. - Two pieces each bracket. 	30607012
HEAD CLAMP		<ul style="list-style-type: none"> - Saddle: 55 mm. - Excursion: 30 mm. 	30607020
		<ul style="list-style-type: none"> - Saddle: 76 mm. - Excursion: 30 mm. 	30607006
TROLLEY		<ul style="list-style-type: none"> - Material: steel. - Saddle: 68 mm. - Excursion: 35 mm. - Max load capacity: 30 kg. - Max travel speed: 100 m/min. 	30607010
		<ul style="list-style-type: none"> - Material: plastic. - Saddle: 55 mm. - Excursion: 10 mm. - Max load capacity: 15 kg. - Max travel speed: 50 m/min. 	30607011

ITEM	PRODUCT	SPECIFICATION	LINE 30
ROUND CABLE TROLLEY		- For round cable from 10 to 25 mm.	30607021
		- For round cable from 26 to 40 mm.	30607022
EXPANSION FOR ROUND CABLE TROLLEY		- For round cable from 10 to 25 mm.	30607025
		- For round cable from 26 to 40 mm.	30607026
TOWING TROLLEY		- Material: steel. - Saddle: 68 mm. - Excursion: 30 mm.	30607007
TROLLEY WITH SOCKET		- 16 poles' socket.	30607027
		- 24 poles' socket.	30607028
		- Without socket.	30607029
END STOP			30607005
END CAP			30607015
END CAP			30607016
CURVED C-RAIL BAR		- Curve radius 1200 mm.	30607031
		- Curve radius 1500 mm.	30607030



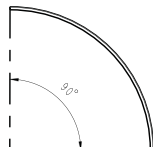

ITEM	PRODUCT	SPECIFICATION	LINE 41	LINE 41 Stainless Steel
C-RAIL BAR		LINE 41 Steel: 4 mt. Stainless steel: 3 mt. - Max load capacity: 140 kg/m.	30602001/4	30602061
JOINT		- Single.	30602002	30602065
		Double. For track > 50 mt.	30602034	30602062
TRACK SUPPORT BRACKET		- Galvanized steel. - Max support spacing: 1 mt.	30602003	30602063
		- Galvanized steel. - Ceiling fixing. - Max support spacing: 1 mt.	30602004	-
HEAD CLAMP		- Saddle: 55 mm. - Excursion: 30 mm.	30602071	30602066
		- Saddle: 76 mm. - Excursion: 30 mm.	30602072	-
TROLLEY		- Material: steel. - Saddle: 68 mm. - Range: 30 mm. - Max load capacity: 35 kg. - Max travel speed: 120 m/min.	30602086	-
		- Material: plastic. - Saddle: 55 mm. - Range: 25 mm. - Max load capacity: 20 kg. - Max travel speed: 60 m/min.	30602069	30602064
		- Material: plastic. - Saddle: 76 mm. - Range: 25 mm. - Max load capacity: 20 kg. - Max travel speed: 60 m/min.	30602070	-

FESTOON
LINE 41 / 41 stainless steel

ITEM	PRODUCT	SPECIFICATION	LINE 41	LINE 41 Stainless Steel
ROUND CABLE TROLLEY		- For round cable from 10 to 25 mm.	36602044	-
		- For round cable from 26 to 40 mm.	30602045	-
EXPANSION FOR ROUND CABLE TROLLEY		- For round cable from 10 to 25 mm.	30607025	-
		- For round cable from 26 to 40 mm.	30607026	-
TOWING TROLLEY		- Single. - Saddle: 68 mm.	30602091	30602067
		- Double. - Saddle: 68 mm.	30602020	-
TROLLEY WITH SOCKET		- 16 poles' socket.	30602041	-
		- 24 poles' socket.	30602042	-
		- Without socket.	30602043	-
END STOP		- Plastic.	30602038	30602068
CURVED C-RAIL BAR		- Curve radius 1500 mm.	30602054	-





ITEM	PRODUCT	SPECIFICATION	MIN. QTY	LINE WIRE ROPE
TWIN ROLLER TROLLEY		<ul style="list-style-type: none">- For flat cable.- Saddle: 55 mm.- Range: 30 mm.	10	30604003
ONE ROLLER TROLLEY		<ul style="list-style-type: none">- For flat cable.- Saddle: 55 mm.- Range: 30 mm.	10	30604005
ONE ROLLER TROLLEY + METAL CABLE CLIP		<ul style="list-style-type: none">- For round cable.- Max diameter 18 mm.	10	30604007

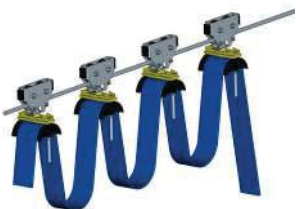

FESTOON
LINE WIRE-ROPE & I-BEAM

I-BEAM TYPE	I-BEAM SIZE	SADDLE (mm)	WHEELS	TROLLEY	TOWING TROLLEY	HEAD CLAMP	
 IPE	80	55	PA	30606003	30606033	30606062	
			acciaio	30606103	30606133		
		85	PA	30606005	30606035	30606063	
			acciaio	30606105	30606135		
	100	55	PA	30606011	30606041	30606066	
			acciaio	30606111	30606141		
		85	PA	30606013	30606043	30606067	
			acciaio	30606113	30606143		
	 IPN	80	55	PA	30606004	30606034	30606062
				acciaio	30606104	30606134	
			85	PA	30606006	30606036	30606063
				acciaio	30606106	30606136	
100		55	PA	30606012	30606042	30606066	
			acciaio	30606112	30606142		
		85	PA	30606014	30606044	30606067	
			acciaio	30606114	30606144		





PVC FLAT CABLE ANTI-AGING HO7VVH6-F

MAIN FEATURES:



Blue colour sheath.
Finish the order code
with "N" for the
black sheath.

- Particularly suitable for supply and control circuits, lifting and handling equipment.
- Comply with: CEI 20-22 II (flame resistant).
- Rated operating voltage: 400V.
- Max short circuit temperature: 160°C.
- Insulation class: 2/3.
- Rated insulation voltage: U₀/U 450/750V.
- Operating temperature: -5°C + 70°C.
- Internal conductors with flexible PVC sheath progressively numbered, plus earth conductor (yellow/green).
- On request the cables can be supplied with a tinned red copper shield heat resistant up to 105 ° C (minimum requirement is 2000 m).

CODE	N° COND. X CROSS SECTION	OUTER SIZES (mm)	STRAND (N°/mm)	WEIGHT (gr/m)	TOTAL CROSS SECTION (mm²)	ELECTRICAL RESISTANCE 20°C (ohm/km)	MAX CURRENT AMBIENT TEMPERATURE 30°C (A)	
							FIXED	MOVED
CP0415AF	4X1.5	15X5.2	30X0.25	150	6	13.30	19.5	17
CP0815AF	8X1.5	29X5.5		300	12		12	10
CP1215AF	12X1.5	41X5		420	18		11	9.5
CP1615AF	16X1.5	54X8		510	24		10	8.5
CP1815AF	18X1.5	43x11		700	27		9.5	8
CP2415AF	24X1.5	51X13		1000	36		9	7.5
CP0425AF	4X2.5	21X5.7	50X0.25	240	10	7.98	26	22.5
CP0825AF	8X2.5	33X6		420	20		18	13
CP1225AF	12X2.5	50X7		640	30		17	12
CP1625AF	16X2.5	41X13		1000	40		16	11
CP1825AF	18X2.5	50X13		1050	45		15	10
CP2425AF	24X2.5	54X13		1100	60		14	9
CP0404AF	4X4	21X7.5	56X0.30	330	16	4.95	35	30
CP0804AF	8X4	38X5		550	32		24	19
CP0406AF	4X6	24X8	84X0.30	440	24	3.30	46	40
CP0806AF	8X6	38.5X8		742	48		32	25
CP0410AF	4X10	35X11	7X12X0.40	800	40	1.91	57	46
CP0416AF	4X16	36.5X12	7X18X0.40	1200	64	1.21	76	62
CP04250AF	4X25	43X13	7X28X0.40	1700	100	0.78	96	80
CP0435AF	4X35	50X14	7X39X0.40	2050	140	0.55	119	99

FLAT CABLE GLAND	Standard		12903010		
	ø28.5 out		12903011		



ROUND CABLE WITH DUAL STRAIN RELIEF STEEL ROPES S05VVD7-F

MAIN FEATURES:



- Made for heavy duty applications, in particular for pendant push button stations and moving electromechanical components.
- The two strain relief ropes avoid any stress on the cable; they are embedded, diametrically opposed to PVC sheath.
- Comply with: CEI 20-22 II (flame resistant).
- Rated operating voltage: 230V.
- Max short circuit temperature: 160°C.
- Ø2mm steel strain relief ropes.
- Insulation class: 2/3.
- Rated insulation voltage: Uo/U 300/500V.
- Operating temperature: -5°C +70°C.
- Breaking point: 60kg/mm².
- Internal conductors with flexible PVC sheath progressively numbered, plus earth conductor (yellow/green).

Blue colour sheath.
Finalize the code with
"N" for the black colour.

CODE	N° COND. X CROSS SECTION	OUTER CABLE Ø (mm) approx	STRAIN RELIEF ROPE	STRAND (N°/mm)	WEIGHT (gr/m)	TOTAL CROSS SECTION (mm ²)	ELECTRICAL RESISTANCE 20°C (ohm/km)	MAX CURRENT AMBIENT TEMPERATURE 30°C (A)	
								FIXED	MOVED
CT0815AUAF	8X1.5	11.6	23.6	30X0.25	225	12	13.30	12	10
CT1215AUAF	12X1.5	14.4	26.4		315	18		11	9.5
CT1615AUAF	16X1.5	16	28		415	24		10	8.5
CT1815AUAF	18X1.5	17	29		470	27		9.5	8
CT2015AUAF	20X1.5	18	30		525	30		9	7.5
CT2415AUAF	24X1.5	21	33		620	36		8.5	7

GIOVENZANA INTERNATIONAL B.V.

1077 XX Amsterdam, The Netherlands
WTC Strawinskylaan 1105
Phone: +31(0) 20.4413576 - Fax: +31(0) 20.4413456
E-mail: giovenzana@giovenzana.com

G.T.R. LLC

127051, Moscow, Russian Federation
Likhov lane, h.3, b.2, office 101
Phone: +7.495.6991296 / +7.499.9228548
E-mail: gtr@giovenzana.com

GIOVENZANA CONTROLS INDIA Pvt. Ltd.

Near Mindspace, Malad West - 400064 Mumbai
A-203, Knox Plaza, Chincholi, Off Link Road
Phone: +91.22.42640071
E-mail: ggindia@giovenzana.com

GIOVENZANA do Brasil

São Paulo - Brasile
Rua Enxovia, 472 cj1904
Cep. 04711-030; Vila São Francisco
Phone: +55 11 3360-6840 / 11 3530-5316
E-mail: logistic.brasil@giovenzana.com

Branch

DUBAI U.A.E. P.O. Box 262146 - J.A.F.Z.A. 15, Jebel Ali Free Zone
Phone: +971.4.8870788 - Fax: +971.4.8870787
E-mail: uae@giovenzana.com



www.giovenzana.com