

# Multipole connectors Naval Applications



ENGLISH

## The Company and the Product

**I.L.M.E. SpA - INDUSTRIA LOMBARDA MATERIALE ELETTRICO** - has been operating in Milan since 1938, in particular in the electrotechnical sector for the manufacturing of equipment for industrial installations.

ILME reflects the traditional entrepreneurial spirit of Lombardy, and has enjoyed continuous expansion for over half a century. The company has carved an important role for itself in the main world markets, also operating directly in the countries that have assumed world leadership in the field of automation, including Germany and Japan. In the electrical connection sector with applications in industrial automation, characterised by top

performance and utmost reliability needs, ILME is today the acknowledged partner of many leading companies worldwide. The company's fundamental values are: product innovation, original solutions, excellent price-quality ratio, a customer-oriented sense of service, ethical behaviour and an environmentally-friendly approach. To promote the continuing improvement of its qualitative results, ILME has always encouraged its collaborators to work with utmost responsibility and participation. The company focuses on a series of benefits to the user, including research into the most suitable materials, high quality and safe cabling, a rapid turnaround and readily available services.



ISO 9001 certification: 2015  
Design, manufacture and distribution of industrial electrical equipment (IAF 19)  
Certificate N° 50 100 11133 - Rev. 01

# Multipole connectors

## Naval Applications

### Table of contents

- 2 **Electrical installations on board ships**  
**Normative references**
- 4 **Overview of the connectors**
- 6 **Inserts**
- 7 **MIXO inserts**
- 8 **Overview of CLASS enclosures**
- 10 **IP68 and W-TYPE enclosures**
- 11 **E-Xtreme® enclosures**
- 12 **Standard enclosures**
- 15 **Accessories**
- 16 **ILME website**
- 17 **Technical catalogues**



## Electrical installations on board ships – Normative references

Electrical installations in seagoing ships are subject to several regulations and standards covering both safety and environmental requirements, most of which either are already or are progressively becoming globally harmonized, due to the inherent interest to establish a shared set of technical safety and environmental requirements for the complete electrical installation and for each of the relevant electrical equipment and components usually foreseen on board.

International standard setting organizations dealing with seagoing ships and relevant safety requirements for electrical equipment are surely ISO (International Standards Organization) with its Technical Committee TC 8 Ships and marine technology, and IEC (International Electrotechnical Commission) with its TC 18 Electrical installations of ships and of mobile and fixed offshore units.

**ISO TC 8** with its many Working Groups and Subcommittees, covers the following scope:

*Standardization of design, construction, structural elements, outfitting parts, equipment, methods and technology, and marine environmental matters, used in shipbuilding and the operation of ships, comprising sea-going ships, vessels for inland navigation, offshore structures, ship-to-shore interface and all other marine structures subject to IMO requirements.*

*Excluded:*

- *electrical and electronic equipment on board ships and marine structures (IEC / TC 18 and IEC / TC 80);*
- *internal combustion engines (ISO / TC 70);*
- *offshore structures for petroleum and natural gas industries, including procedures for assessment of the site specific application of mobile offshore drilling and accommodation units for the petroleum and natural gas industry (ISO / TC 67 / SC 7);*
- *steel and aluminium structures (ISO / TC 167);*
- *equipment and construction details of recreational craft and other small craft (not being lifeboats and lifesaving equipment) less than 24 metres in overall length (ISO / TC 188);*
- *sea bed mining;*
- *equipment which is not specific for use on board ships and marine structures (e.g. pipes, steel wire ropes, etc.) and falling within the scope of particular ISO technical committees with which a regular mutual liaison must be maintained.*

ISO TC 18 has to date (as of 2017-05-03) 306 published standards, 88 ISO standards under its programme of work, 22 countries participating as members and 26 countries participating as observers.

**IEC TC 18**, with its subcommittee SC 18A dealing particularly with cables, and its several Maintenance Teams and Working Groups, has the following scope: *To prepare standards for electrical installations and equipment of ships and of mobile and fixed offshore units, incorporating good practice and aligning as far as possible existing regulations and IEC Publications.*

<sup>1</sup>**SOLAS = Safety Of Life At Sea**, refers to the International Convention for the Safety of Life at Sea (SOLAS), of 1974, adopted on 1<sup>st</sup> November 1974 and entered into force on 25<sup>th</sup> May 1980. It is generally regarded as the most important of all international treaties concerning the safety of merchant ships. The first version was adopted in 1914, in response to the Titanic disaster, the second in 1929, the third in 1948, and the fourth in 1960. The 1974 version includes the tacit acceptance procedure – which provides that an amendment shall enter into force on a specified date unless, before that date, objections to the amendment are received from an agreed number of Parties. As a result the 1974 Convention has been updated and amended on numerous occasions. The Convention in force today is sometimes referred to as SOLAS, 1974, as amended. The main objective of the SOLAS

*The standards will chiefly concern:*

- a) factors promoting the safety of ships and of mobile and fixed offshore units;*
- b) factors promoting safety of life.*

*The standards will form a code of practical interpretation and amplification of the requirements of the International Convention on Safety of Life at Sea, a guide for future regulations may be prepared by Administrations, and a statement of practice for use by builders and appropriate organizations. The standards will also foster interchangeability of parts and ease the selection and procurement of equipment, including cables for transport of energy, signals and data, by indicating, as appropriate, IEC standards of ratings, types, dimensions, materials, quality, test methods, etc., whether or not these are influenced by regulations, and will thus facilitate interchanges between purchaser and supplier.*

IEC TC 18 has to date (as of 2017-05-03) 48 IEC standards published, 17 projects of work undergoing, 15 countries participating as members and 15 countries participating as observers.

Besides ISO and IEC, the **International Maritime Organization (IMO)** has its own set of regulations affecting seagoing ships. The IMO is a specialized agency of the United Nations which is responsible for measures to improve the safety and security of international shipping and to prevent pollution from ships. It is also involved in legal matters, including liability and compensation issues and the facilitation of international maritime traffic. It was established by means of a Convention adopted under the auspices of the United Nations in Geneva on 17 March 1948 and met for the first time in January 1959. It currently has 172 Member States. IMO's governing body is the Assembly which is made up of all the Member States and meets normally once every two years. It adopts the budget for the next biennium together with technical resolutions and recommendations prepared by subsidiary bodies during the previous two years. The Council, of 40 Member States elected by the Assembly, acts as governing body in between Assembly sessions. It prepares the budget and work programme for the Assembly. The main technical work is carried out by the Maritime Safety, Marine Environment Protection, Legal, Technical Co-operation and Facilitation Committees and a number of sub-committees. The IMO slogan sums up its objectives: "Safe, secure and efficient shipping on clean oceans".

### Classification societies

All ships must be surveyed in order to be issued certificates which establish their seaworthiness, type of ship, and so on and this is the responsibility of the flag State of the vessel. However, the flag State ("Administration") may "entrust the inspections and surveys either to surveyors nominated for the purpose or to organizations recognized by it" (SOLAS<sup>1</sup> Chapter 1, regulation 6).

In practice these "recognized organizations" are often the classification societies. IMO has adopted a mandatory Code for recognized organizations

Convention is to specify minimum standards for the construction, equipment and operation of ships, compatible with their safety. Flag States are responsible for ensuring that ships under their flag comply with its requirements, and a number of certificates are prescribed in the Convention as proof that this has been done. Control provisions also allow Contracting Governments to inspect ships of other Contracting States if there are clear grounds for believing that the ship and its equipment do not substantially comply with the requirements of the Convention - this procedure is known as port State control. The current SOLAS Convention includes Articles setting out general obligations, amendment procedure and so on, followed by an Annex divided into 12 Chapters. For more details see <http://www.imo.org>.

(RO Code), which provides flag States with standards mechanisms for the oversight, assessment and authorization of recognized organizations (ROs) and clarifies the responsibilities of such organizations. The International Association of Classification Societies (**IACS**) is a Non-Governmental Organization which was granted Consultative Status with IMO in 1969. Classification societies (also known as naval registers) are one of the members of said association nowadays counting 12 member societies: **ABS** (America Bureau of Shipping), **BV** (Bureau Veritas), **CCS** (China Classification Society), **CRS** (Croatian Register of Shipping), **DNV GL** (Det Norske Veritas Germanischer Lloyd, who merged in late 2013), **IRS** (Indian Register of Shipping), **KR** (Korean Register), **LR** (Lloyd's Register), **NK** (Nippon Kaiji Kyokai), **PRS** (Polski Rejestr Statków), **RINA** (Registro Italiano Navale), **RS** (Russian Maritime Register of Shipping). Each of these classification societies issues and keeps updated a very articulated set of technical regulations, mainly covering very important mechanical, electrical and safety-related aspects of ships and offshore units.

With the growing development of the electric traction technology for ships, also for very large vessels, the tailoring of the technical requirements for electrical equipment and components to the specific constraints of the marine environment is gaining more and more interest, in view of e.g. reliability, containment of costs for refurbishing, and energy saving. Refurbishing is particularly due to the harsh environment that the marine environmental conditions pose to such equipment, either installed indoor or outdoor.

## IEC Standards

Among the most important and fundamental requirements are those set in the **IEC 60092** series of standards under the responsibility of TC 18, whose title includes **IEC 60092-101** *Electrical installations in ships – Part 101: Definitions and general requirements*, which stands as the main part of this family of standards which nowadays counts already 30 publications. As perfectly focused in its introduction *“These standards form a code of practical interpretation and amplification of the requirements of the International convention on safety of life at sea [SOLAS], a guide for future regulations which may be prepared and a statement of practice for use by shipowners, shipbuilders and appropriate organizations”*.

## Fire behaviour

Another important aspect to consider for electrical equipment and components is that of **fire behaviour**. Particularly now that giant cruiser ships able to host the population of a small town (5000 and more passengers plus crew and service personnel) it becomes essential that any accidental source of fire be contained (i.e. not propagated), quickly extinguished and that the effluents of such fire do not pose any serious risk for panic and health of people.

In this field, often sad to say based on tremendous accidents occurred, the field of rail transportation has pushed manufacturers of thermoplastic materials to develop materials with low toxicity and low smoke density. Flame retardant technology has also made giant progress and the ban of the so-called *substances of very high concern* for health (SVHC) imposed by regional regulations like the European REACH Regulation No.

1907/2006 and similar ones adopted in other areas of the globe, lead to replace traditional halogen composites or red phosphorous composites with identically – when not even better – performing formulations free from any (known) detrimental effect on health and environment.

ILME electrical multipole connector inserts are made by thermoplastic materials qualified according **EN 45545** series of standard with the maximum applicable sets of requirements (R22 for installation inside railway vehicles, i.e. passenger cars and R23 for outdoor installation in railway vehicles, hazard level HL3 (the top one)). EN 45545 series are amongst the most advanced worldwide and a benchmark for other regional regulations for fire behaviour in rail transportation. See CN.16 Catalogue pp. 24-25 for further details.

## Vibration and shock, humidity, temperature, UV and corrosive atmosphere in marine environment

Among the most important parameters describing the harsh environmental condition that electrical equipment has to withstand when installed on board seagoing ships are the condition of exposure to vibration and shocks (due to mechanical movement of engines, ship propellers and wave motion in open sea, or when used in hoisting devices e.g. in cranes on board ships), as well as thermal and relative humidity cycling with condensation, exposure to UV radiation (sunlight), and – most of all – corrosive atmosphere due to sea salt. Marginally, also the resistance to chemicals (e.g. diesel fuels) may have its relevance, depending on the location on board the ship a connector is being installed.

## ILME connectors and enclosures Type Approval Certificates

Besides being third party certified by Underwriters Laboratories with **cULus**, Canadian Standards Association with **CSA**, China Quality Certification with voluntary mark **CQC**, EAC with **EAC** mark and in compliance with the relevant European safety standards IEC/EN 61984, IEC/EN 60529, IEC/EN 60664-1, IEC/EN 61076-7-100 and EN 175301-801 as far as applicable with **CE** marking, see Catalogue CN.16 for further details, ILME connectors and enclosures have been approved since more than one decade by **DNV GL** with Type Approval Certificate no. TA0000197 of 2016-07-18 in accordance with *DNV GL Rules for classification – Ships and offshore units*.

The rules of DNV GL provide a classification into several zones in view of their location on board a ship or offshore unit (related to different environmental categories) with increasing harshness of test requirements. ILME connector inserts and relevant hoods and housings are being qualified under former class D of GL Rules, so that they can be installed also in proximity of diesel engines (higher level of vibration and shock up to 4,0 g). The relevant DNV GL Type Approval Certificate is going to be updated also to include new series of connectors and enclosures. Consult our Sales Offices for further details.

At the same time ILME is applying for approval of their range of connectors and connector enclosures by **Bureau Veritas** under the VeriSTAR certification scheme, with a Type Approval similar to that of DNV GL, being also BV technical rules based on IEC 60092 standards. Consult our Sales Offices for further details.

# Overview of the connectors



## Open deck

### E-Xtreme® C7 IP67 Enclosures

CX MIXOBUS Inserts



### E-Xtreme® IP68 Enclosures

CX 6/6, 100A/16A Inserts

MIXO (up to 200A) CDD / CQE Inserts



### IP68 Enclosures

CQ 12 / CQ 05 Inserts



## Boat cleaning system

COB Enclosures  
The complete set of inserts

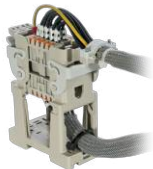

C-TYPE Enclosures  
The complete set of inserts

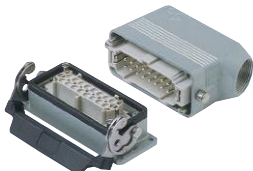

## Bridge

EMC Enclosures



T-TYPE/W Enclosures  
IP68 NEMA4 Version



RJ45 Inserts



## Cabins

COB Enclosures  
The complete set of inserts



C-TYPE Enclosures  
MIXO 16A/40A/70A/100A/200A Inserts



CK/CKA Enclosures  
CK/CKS Inserts



## Engine room

**E-Xtreme® IP68 Enclosures**  
CQEE Inserts



**E-Xtreme® IP68 Enclosures**  
MIXO (up to 200A)  
CDD / CQE Inserts



EMC Enclosures



CR...SP/FS/SS Anchors  
for panel installation

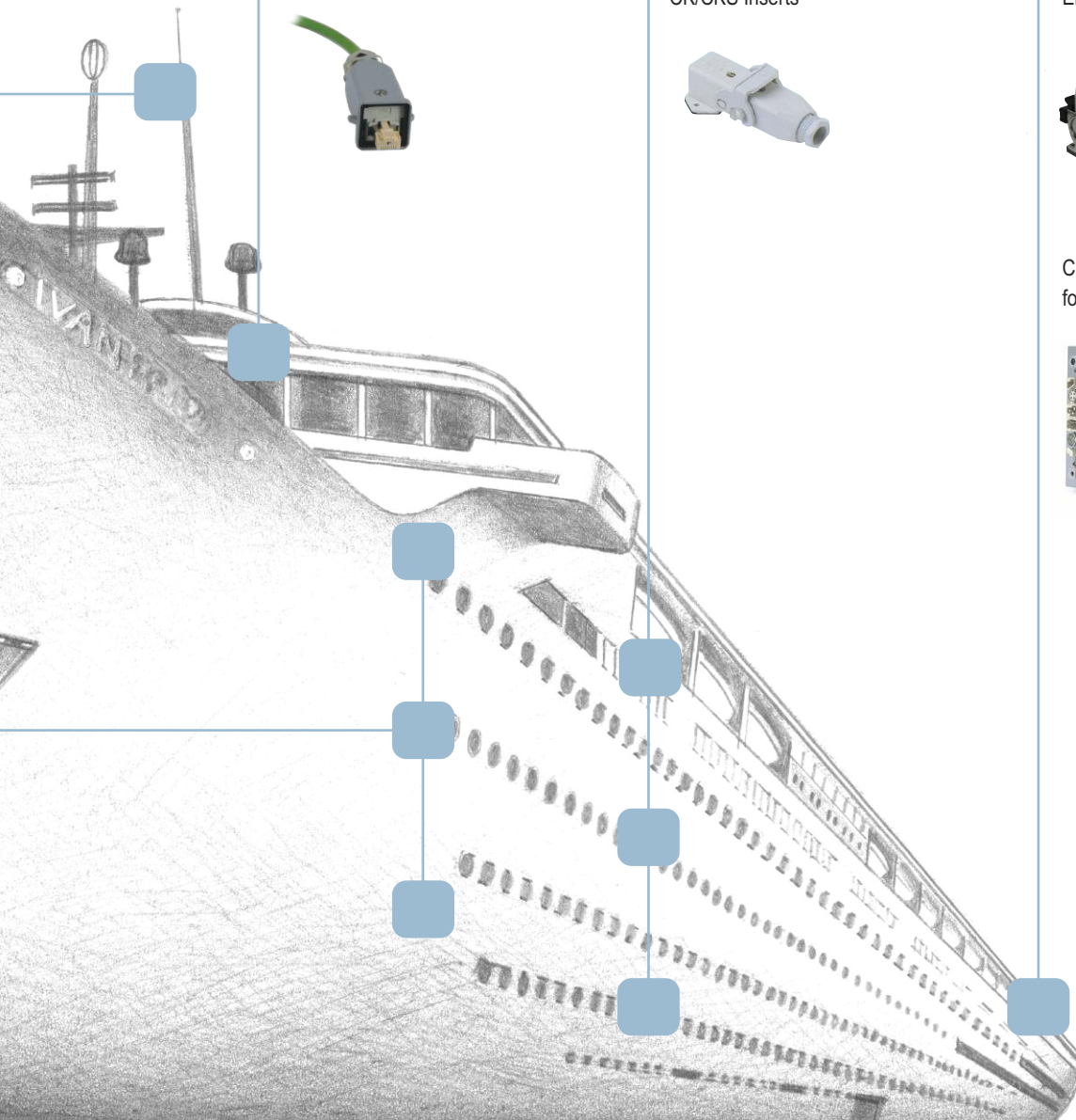

## Inserts for multipole connectors

Inserts for multipole connectors are made of self-extinguishing thermoplastic resin UL 94 V-0, normally used for applications in a maximum ambience temperature of 125 °C. Different conductor connection techniques are available: screw, crimp or flexible spring. The contacts are in silver or gold plated brass. Inserts are numbered on both sides by laser printing or moulded.

There is a large number of versions of inserts selected on the basis of the rated voltage (from 50V to 5000V), the rated current (from 5A to 200A max), the number of poles, the different load combinations required (power and signal poles within the same insert). Inserts are approved in accordance with the approval marks including UL, CSA, CQC, DNV-GL and EAC.

**CQEE**  
16A CRIMP Contacts



**CQE - CCE - CX**  
16A/40A CRIMP Contacts



**CD-CDD**  
10A CRIMP Contacts



**CX 6/6**  
16A/100A CRIMP Contacts



**CRIMP Contacts**  
silver - gold plated



**CQ**  
10A/16A/40A  
CRIMP Contacts



## SQUICH® Series >

**CSH SQUICH®**  
16A SPRING contacts  
with actuator

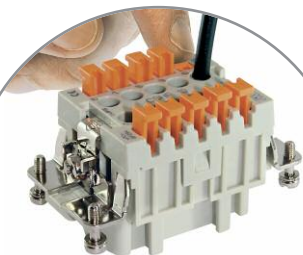

**CDSH SQUICH®**  
10A High density SPRING  
contacts with actuator

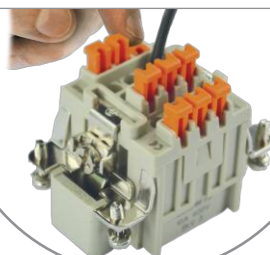

**CKSH SQUICH®**  
10A SPRING contacts  
with actuator

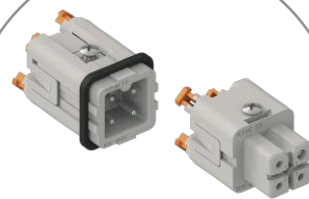



## MIXO Inserts for multipole connectors

The MIXO Series range is a system of modular units for special applications that uses traditional enclosures. Each enclosure can house different types of connections such as: electrical signals and contacts for the conduction of compressed air, fibre optic connectors, connectors for Ethernet networks, USB and coaxial connectors.

The insert compartments are made up by installing several modules next to one another in order to form a single compact block that is then mounted on metal frames with mandatory housings. Once the modules have been inserted and locked with the special tabs, the connector can be inserted into the enclosure.

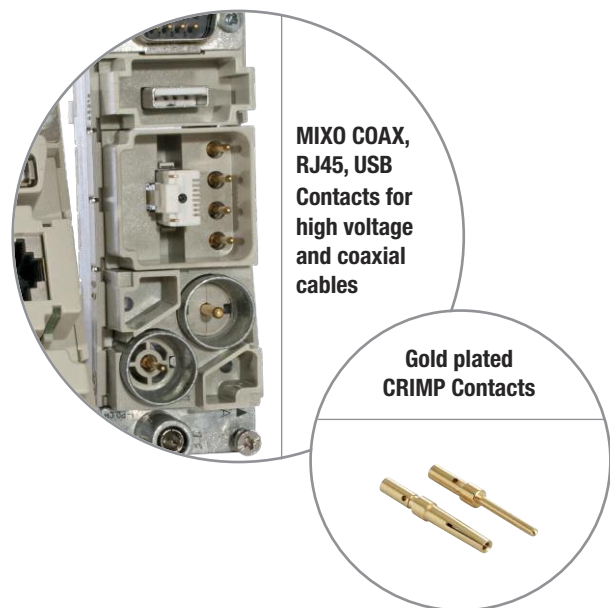
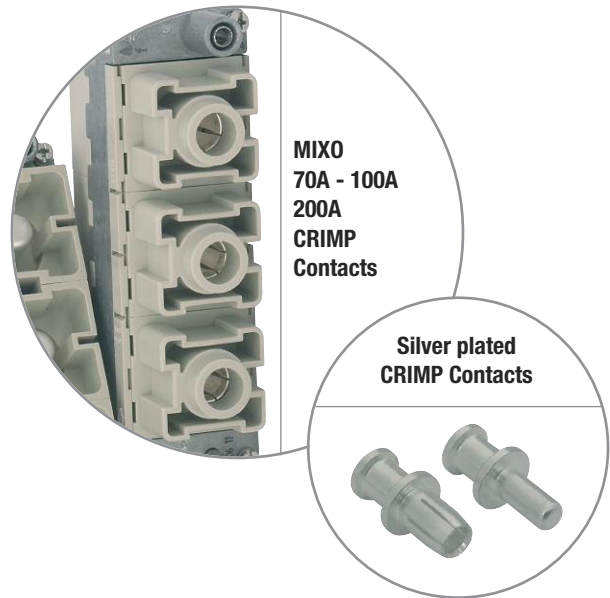
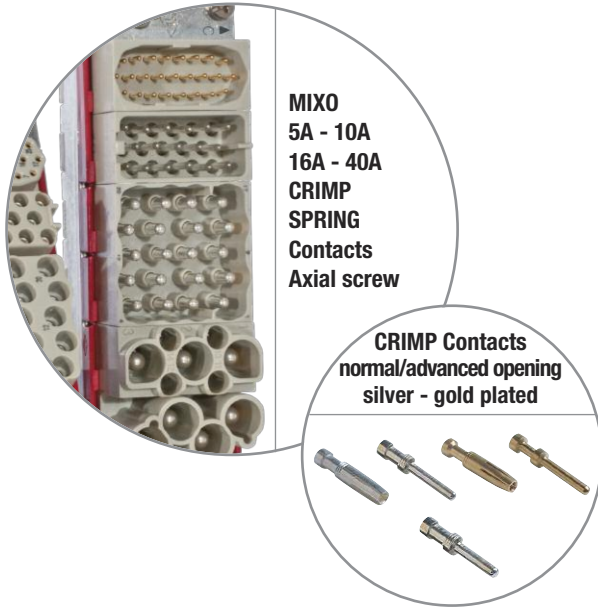

## Enclosures for multipole connectors

A large number of enclosure versions are available with different combinations of component materials, each one suitable for a specific installation: normal environmental conditions, high temperature environments, aggressive environments and environments that require electromagnetic compatibility.

The principal parts are made in die cast aluminium alloy with a coating of epoxy-polyester powder or in self-extinguishing thermoplastic insulating. They are resistant to impacts and strong mechanical stress.

### Watertight >

**Watertight in a limited space**

- Metallic
- Lever in stainless steel
- IP66/IP67



**V-TYPE  
IP67**

**Watertight**

- Metallic
- Rigid locking lever in stainless steel
- IP66/IP67



**CZ7**



**Watertight**

- Mechanical robustness
- Resistant to chemical agents
- Screw or bayonet locking
- IP66/IP68



**IP68**

### Infrastructures & Standard environments >

**Insulating or Metallic**  
- IP44, IP66/67



**CK-CKA**

**Insulating**  
- IP66/IP67  
- Up to 40A inserts



**CQ**

**Mounting inside control panel**  
- Inspectable  
- IP20



**COB**

**Classic, flexible**  
- Metallic  
- CLASS rotative lever  
- IP65/IP66



**C-TYPE**

**Reduces the stress of closing lever**  
- Metallic  
- Stainless steel and thermoplastic material  
- IP66



**IL-BRID**

**Standard connections**  
- Insulating  
- Robust  
- Resistant to chemical agents  
- IP65



**T-TYPE**

## Enclosures for multipole connectors

The coupling stability and protection against accidental opening are assured by single or double closing devices comprising levers, springs and pegs in stainless steel or entirely in plastic. Sealing is assured by special gaskets that protect the contact groups inside the enclosures against dust and aggressive agents.

In general, the coupled enclosures with the appropriate user-selected connections guarantee IP44, IP65, IP66, IP67, IP68 and IP69 (IEC/EN 60529) protection rating.

### Aggressive Environments >

#### Corrosion-proof

- 3.000 hours in salt spray tests
- Durable protection against damage caused by: stone chip, icing, salt mist, UV radiations and harsh gases

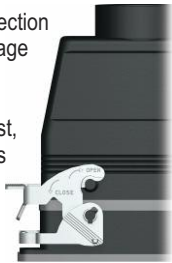

#### E-Xtreme®



- #### Aggressive external agents
- Metallic with chrome treatment
  - IP66



#### W-TYPE

- #### Aggressive external agents
- Insulating
  - Robust
  - Chemical resistant
  - IP66



#### T-TYPE/W

### Special Enclosures >

#### Large and modular hoods

- Multiple cable entries
- Simple and easy to inspect cabling
- Electronic card slots
- IP66



#### BIG

#### Electromagnetic compatibility

- Conductive gaskets
- IP66



#### EMC

#### Limited mounting spaces

- Reduces insert uncoupling stress
- IP65/IP66



#### CENTRAL LEVER

### Variants >

#### ROTATIONAL LEVER



#### CLASS

#### VERTICAL LEVER

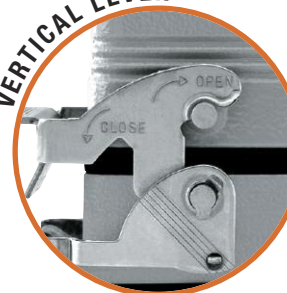

#### V-TYPE

#### SELF-CLOSING COVER



#### SIMPLEX

## Enclosures for multipole connectors

### IP68 >

The hoods with IP68 protection rating are particularly suitable for any application requiring high resistance to pressure, impact and corrosion. They also ensure a good screening for electromagnetic compatibility, resistance to vibrations in compliance with EN 61373 standard and to pressurised water.



Scan to watch the specific movie!



IP68 CGK



> Screw locking



> Bayonet locking



### W-TYPE >

The Heavy Duty Series are specifically **designed for applications where aggressive external agents** are present. The series are available in 10 different sized enclosure ranges.



Scan to watch the specific movie!

Housings are available in bulkhead or surface mounting. Hoods are available with side or top entry and **easily identified because of their black finish.**



E-Xtreme® enclosures



## E-Xtreme® > Titanium plasma protected, 3.000 hours in salt spray tests



Scan to watch the specific movie!

The new metal enclosures E-Xtreme® Series are the best protection for **extreme** heavy-duty environments. Their **special patented protective coating** assures a high level of protection against the corrosion even in case of long term exposure to salt mist. **The protection is granted also in case of impact with stones and sand.** The materials are able to withstand UV radiations, a wide temperature range and harsh chemicals. The E-Xtreme® series are available in the full range of Ilme aluminum hoods and housings versions.

C-Type LEVER



V-Type LEVER



environments

- icing
- very low temperatures
- salt mist
- impact resistant
- UV radiations
- chemical resistant
- high number of matings

advantages

- 3.000 hours in salt spray tests
- IP66 / IP67 / IP69 protection degree (EN 60529)
- corrosion-proof aluminium with a special coating under the powder painting colour RAL 7016 dark grey
- FKM gasket (-40 °C... +180 °C) or silicone gasket (-60 °C... +180 °C)
- V-Type lever or C-Type lever, hood with moulded pegs or riveted stainless steel bolts
- durable protection against damage caused by stone chip, icing, salt mist, UV radiations and harsh gases

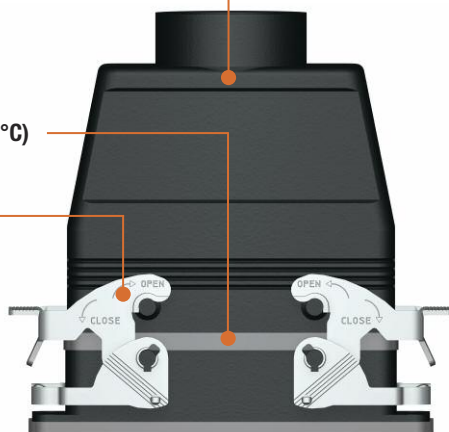

## COB SYSTEMS ›

The COB Systems allow to use multipole connectors within electric panels without the traditional metallic housing, as protection is assured by the electric panel itself or other boxes. COB Systems may be assembled in the three following ways:

- on panels by the window snap fastening device;
- on DIN EN 60715 rails, both lengthways and crossways to the support;
- on fixed panels by using screws.



Scan to watch the specific movie!

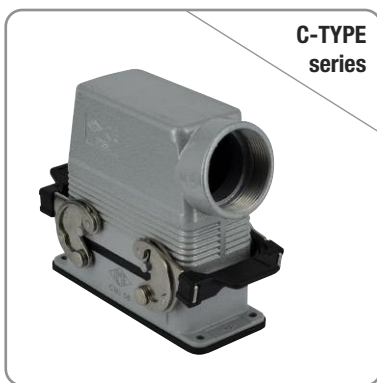
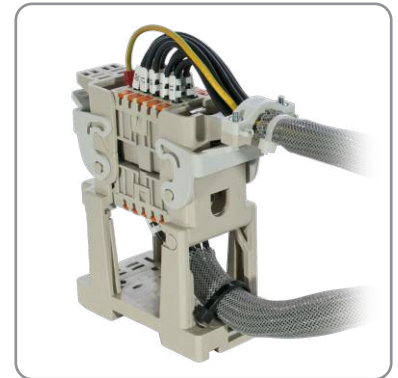

**C-TYPE series**

## ◀ C-Type CLASS

A large number of enclosure versions are available with different combinations of component materials, each one suitable to a specific installation: normal environmental conditions, high temperature environments, aggressive environments and environments that require electromagnetic compatibility. The coupling stability and protection against accidental opening are assured by single or double closing devices comprising levers, springs and pegs in stainless steel or entirely in plastic (CK and CQ series). Sealing is assured by special gaskets that protect the contact groups inside the enclosures against dust and aggressive agents.



Scan to watch the specific movie!

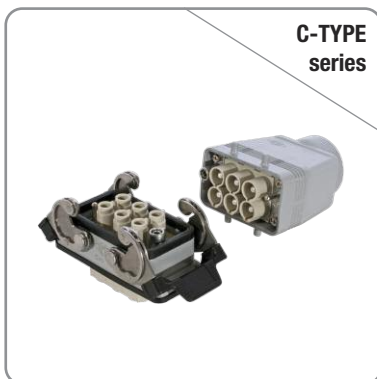

**C-TYPE series**



**CK series**



**CQ 08 series**



## ◀ EMC

The EMC enclosure's surfaces are treated to make them extremely conductive while maintaining the necessary corrosion resistance. The bulkhead mounting housing has a special conductive gasket. For best results the surface underneath the gasket should be conductive. Since the use of this enclosure system presupposes the use of shielded cables, the hood should comprise a special cable gland with anchoring device for the cable shield. These metal cable glands ensure IP66 protection rating, are resistant to corrosion and equipped internally with a contact element with geometry that ensures uniform earthing of the cable conductor shield on the metal shell of the hood.



Scan to watch the specific movie!



## ◀ V-TYPE IP67

Due to the vertical closing movement, the new lever offers an IP66/IP67 protection (according to EN 60529) when fitted with a complete and coupled connector and used with ILME standard hoods in die cast aluminum with pegs (without adaptor).



Scan to watch the specific movie!

The tight seal after closure and the simplicity of the movement are the key features that only ILME has managed to combine into a single lever.

The V-Type lever also has other interesting functional characteristics for several applications:

- the friction on the pin is almost zero because the lever exerts its pressure vertically, thus significantly reducing wear in case of frequent use;
- the complete lever is manufactured in stainless steel and is fitted with a catch that prevents it from being accidentally detached;
- the absence of parts in plastic offers a higher resistance to impacts and to contact with oils and aggressive chemical substances or high ambient temperatures;
- the lever can be used for applications with vibrations because it has no springs and is therefore more rigid;
- the lever occupies a very small space during the closing phase;
- it is recommended in cases in which the weight of the cable tends to open elastic levers, like those with vertically installed connectors and cable exits in the bottom.

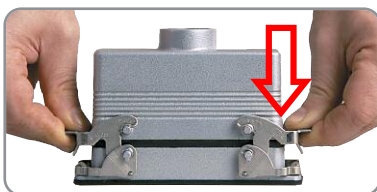

› Closing phase

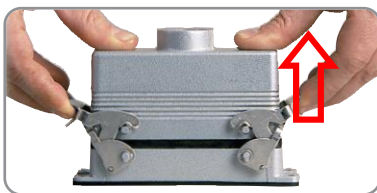

› Opening phase

## BIG HOODS › Large modular enclosures, more entries and space for cables



Scan to watch the specific movie!

The BIG Series, based on the wide-ranging experience achieved by ILME, introduce a significant change in the design of hoods and have been specifically designed to meet the new requirements of the wiring market.

The large dimensions of these innovative enclosures have been chosen to offer customers an adequate space to store conductors.

The cable compartment is now fully accessible during assembly (the connector insert is fully inserted in the lower half of the enclosure). Offering three time the space compared to standard enclosures. This means it is possible to bend cables and pipes with greater bending radiuses.

Due to this special feature, the new BIG enclosures are particularly suitable for MIXO modular inserts, being versatile and customizable, for multiple cable entries. Each insert, that is used to manage power and signal electrical connections, pneumatic, fibre optic or Ethernet connections, has a dedicated entry so that it is now possible to use one BIG connector enclosure for installations that previously required two.





## ‹ T-TYPE Series

The new T-TYPE Standard and T-TYPE/W Enclosures in **self-extinguishing thermoplastic material** can be particularly used in railway infrastructures.



Scan  
to watch  
the specific  
movie!

The following are the valuable characteristics of both these new enclosures:

- **pre-fastened built-in polyurethane gaskets** for easier installation;
- **external dimensions** of the bulkhead housing are similar to those of the corresponding metal enclosures; hole fixing centres are unchanged;
- **ample space** inside enclosures for cables, with mounted connectors, similar to the corresponding metal high construction versions;
- possibility of making **completely insulated constructions** (equivalent to Class II);
- **absence of powder paint** for environments in which these are not recommended;
- **non-electrostatic** thermoplastic material;
- manufactured from **insulating material**, do not require special reinforced insulation as the metal versions do, for use with series CME higher voltage connector inserts (screw-type terminals).

### T-TYPE Standard ›

- **Built-in polyurethane gaskets;**
- Enclosures in thermoplastic material, **dark grey RAL 7012 colour**, with high thicknesses providing structural solidity and durability.
- **Locking levers** in thermoplastic material colour grey RAL 7001.
- M25, M32 and M40 threaded **cable entries**.
- **IP65** degree of protection according to EN 60529.
- **UL TYPE 12** degree of protection according to ANSI/UL50.
- Each enclosure carries its own part number, thread/size, conformity **markings** and UL type rating.
- Ambient **temperature** range: -40 °C / +90 °C



### ‹ T-TYPE/W

- Enclosures in **thermoplastic material**, dark grey RAL 7012 colour, with high thicknesses providing structural solidity and durability.
- **Built-in FKM fluoroelastomer sealing gaskets.**
- **Locking levers** in thermoplastic material colour grey RAL 7001.
- M25, M32 and M40 threaded **cable entries**.
- **IP66** degree of protection according to EN 60529.
- Each enclosure carries its own part number, thread size and conformity **markings**.
- Ambient **temperature** range: -40 °C / +90 °C.

As the characterizing element of the T-TYPE/W series is the different sealing gasket material, hoods and covers without sealing gaskets for these series are the same of T-TYPE Standard.



## Accessories for multiple connectors

### CR...SP/SS/FS ANCHORS >

The CR...FS Series of anchorages are designed for use with connector inserts (normal or MIXO modular) without enclosures and enable securing cables with clamps to prevent transmitting friction forces to contacts. CR...SS anchorages (with grip to facilitate detachment) are used for earth connecting several conductors and/or for the screen of shielded cables.

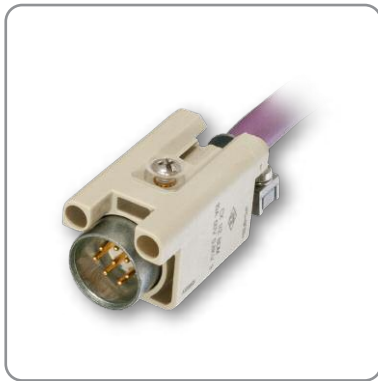

### < CX 1/2 BD INSERT ADAPTORS

The new CX 1/2 BD Insert Adaptors allow to use round shielded connectors series MIXO BUS (multiaxial, for balanced cables with multiple pairs) or coaxial connectors (for coaxial cables) even in compact enclosures size "21.21" **CKA/MKA or CGK/MGK**. This insert can be used to assemble MIXO coaxial connectors **CX 01 BM/BF** for coaxial cables with a typical impedance of 75  $\Omega$  and **CX 01 BCM/BCF** for coaxial cables with a typical impedance of 50  $\Omega$ , or **MIXO BUS CX 04 BM/BF** multiaxial shielded connectors with 4 poles + shield and the new **CX 08 BM/BF** shielded connectors with 8 poles + shield, providing **seats for 2 additional optional contacts** series CD for the connection of a SELV (very low safety voltage) supply line.

### CR SC / AT / ST SHIELDED CONNECTORS >

The CR SC / AT / ST Shielded Connectors have their shield insulated from the enclosure's earthing point. If you wish to earth-connect the shield, install on the panel an anchorage for shielded cables CR...ST or the CR GND metal adaptor.

Anchorage CR...AT/ATD are designed for installation on the frames of the MIXO modular connectors for earth connecting several cables.

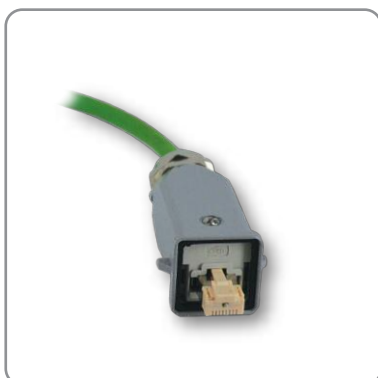
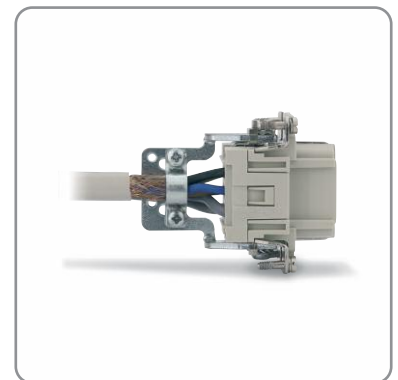

### < RJ45 CONNECTORS

RJ45 connectors are available both in modular versions and for enclosures series CK-CKA in Ethernet Category 5 and Category 6<sub>A</sub>.

ON-LINE  
CONFIGURATOR

www.ilme.com  
VISIT OUR WEBSITE  
WITH NEW  
FUNCTIONALITIES!

CAD  
DRAWINGS

PARTNERSHIP  
WITH



WEB  
RESPONSIVE

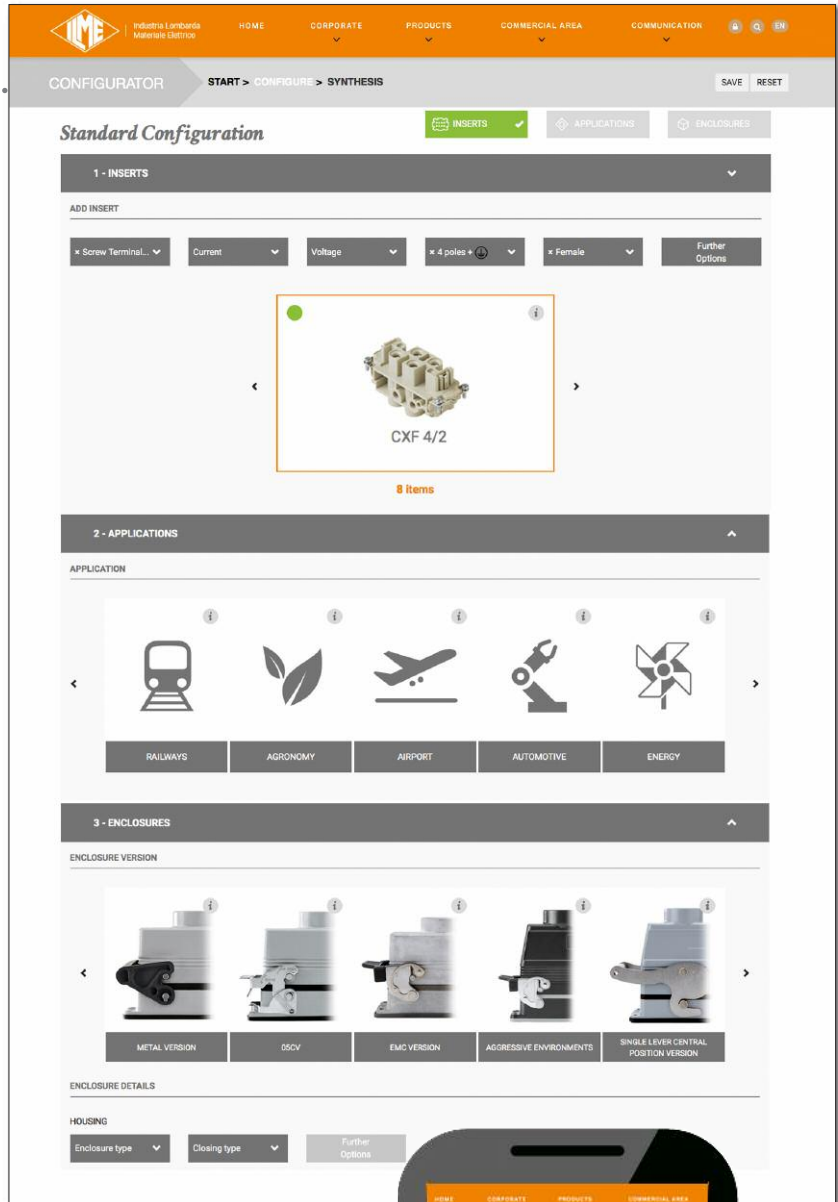



**New products 2017**  
Multipole connectors  
including **E-Xtreme®** Series



**CN16**  
Multipole connectors

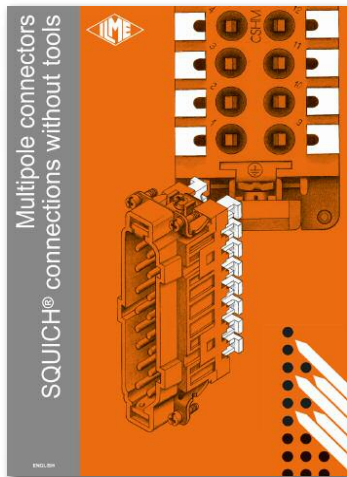

**CSH-SQUICH®**  
Connection without tools

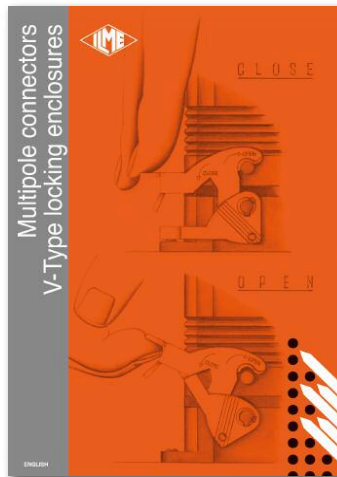

**V-TYPE IP67 ENCLOSURES**  
V-Type locking enclosures



**T-TYPE**  
**THERMOPLASTIC ENCLOSURES**  
Including W version

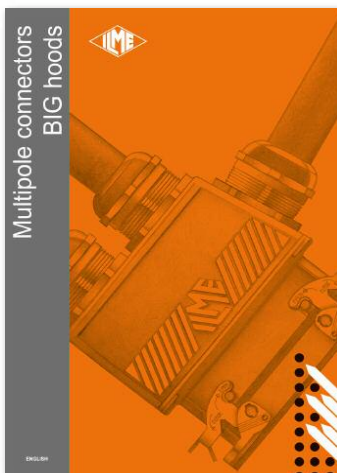

**BIG HOODS**  
The space you have  
always wanted

**I.L.M.E. SpA**

Via Marco Antonio Colonna, 9  
20149 Milano - Italy  
☎ +39 02345605.22 - fax +39 02331058.13  
[www.ilme.com](http://www.ilme.com)

**ILME FRANCE S.A.R.L.**

Rue Roland Garros - BP 125  
Parc d'Activités de l'Aéroport  
42160 Andrézieux-Bouthéon - France  
☎ +33 (0) 4 77 36 23 36 - fax +33 (0) 4 77 36 97 97  
[ilme-france@ilme.fr](mailto:ilme-france@ilme.fr)  
[www.ilme.fr](http://www.ilme.fr)

**ILME GmbH**

Max-Planck-Straße 12  
51674 Wiehl - Germany  
☎ +49 (0)2261 - 7955-0 - fax +49 (0)2261 - 7955-5  
[technik@ilme.de](mailto:technik@ilme.de)  
[www.ilme.de](http://www.ilme.de)

**ILME UK LIMITED**

50 Evans Road, Venture Point  
Speke, Merseyside L24 9PB - United Kingdom  
☎ +44 (0) 151 3369321 - fax +44 (0) 151 3369326  
[sales@ilmeuk.co.uk](mailto:sales@ilmeuk.co.uk)  
[www.ilmeuk.co.uk](http://www.ilmeuk.co.uk)

**ILME NORDIC AB**

Transportvägen 18  
24642 Löddeköpinge - Sweden  
☎ +46 46 18 28 00 - fax +46 46 18 28 10  
[info@ilme.se](mailto:info@ilme.se)  
[www.ilme.se](http://www.ilme.se)

**ILME JAPAN CO. LTD.**

Kobe International Business Center - 650-0047, 5-2, 5 - Chome,  
Minatojima Minami-Machi - Chuo-Ku, Kobe - Japan  
☎ +81 7830 22005 - fax +81 7830 22060  
[info@ilmejapan.co.jp](mailto:info@ilmejapan.co.jp)  
[www.ilme.jp](http://www.ilme.jp)

**ILME CHINA CO. LTD.**

Room 307, D area, No. 245,  
Xin Jun Huan Road, MinHang Dis  
201114 Shanghai - China  
☎ +86 21 6248 9961 - fax +86 21 3478 8067  
[info@ilmechina.com](mailto:info@ilmechina.com)  
[www.ilmechina.com](http://www.ilmechina.com)

[www.ilme.com](http://www.ilme.com)

XDG MAR 517



Catalogues

