

Compact Three-phase and Neutral Line Filter for High Frequency Attenuation

3-Phase + Neutral Line Filters FN 354



- Compact four-wire filter for applications with limited space
- High attenuation performance up to 300 MHz
- Equally suitable for star and delta power networks



Performance indicators



Technical specifications

Maximum continuous operating voltage	3x 440/250 VAC
Operating frequency	dc to 60 Hz
Rated currents	4 to 25 A @ 40 °C
High potential test voltage	P → E 2000 VAC for 2 sec P → P 1900 VDC for 2 sec
Protection category	IP20 (version with -47 connections)
Overload capability	4x rated current at switch on, 1.5x rated current for 1 minute, once per hour
Temperature range (operation and storage)	-25 °C to +100 °C (25/100/21)
Flammability corresponding to	UL 94 V-2 or better
Design corresponding to	UL 1283, CSA 22.2 No. 8 1986, IEC/EN 60939
MTBF @ 40°C/230V (Mil-HB-217F)	500,000 hours

Approvals



Features and benefits

- The FN 354 family of filters is intended primarily for applications that require extremely effective interference suppression across a broad frequency spectrum.
- Advanced two-stage filter circuits with highly saturating resistant toroidal inductors, in conjunction with feedthrough capacitors on each of the three phases and the neutral line, ensure that these filters provide very high attenuation in the upper frequency band.
- FN 354 are equally suitable for the operation on star and delta power networks.

Typical applications

- Applications requiring high-frequency attenuation
- Power supplies
- Medical equipment
- Office and data processing equipment

Typical electrical schematic

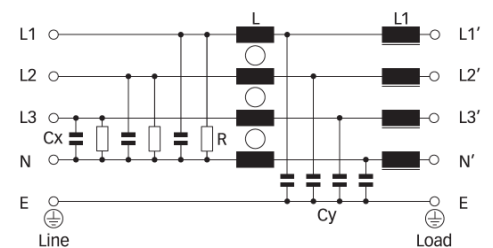

Filter selection table

Filter	Rated current @ 40 °C (25 °C)	Leakage current* Power loss	Power loss @ 25 °C/50 Hz	Input/Output connections	Weight [kg]
	[A]	[mA]	[W]		
FN 354-4-05	4 (4.5)	0.175	2.0	-05	0.23
FN 354-6-05	6 (6.7)	0.175	3.9	-05	0.38
FN 354-12-05	12 (13.4)	0.175	7.8	-05	1.1
FN 354-15-47	15 (16.8)	0.5	10.8	-47	4.7
FN 354-25-47	25 (28)	0.5	16.9	-47	4.7

* Maximum leakage under normal operating conditions, based on the assumption that all three phases and the neutral conductor are connected to the supply and the consumer. In this case, the current will mainly return through the neutral line, not as earth leakage.

Typical filter attenuation

Per CISPR 17; A = 50 Ω/50 Ω sym; B = 50 Ω/50 Ω asym; C = 0.1 Ω/100 Ω sym; D = 100 Ω/0.1 Ω sym

4 and 6 A types

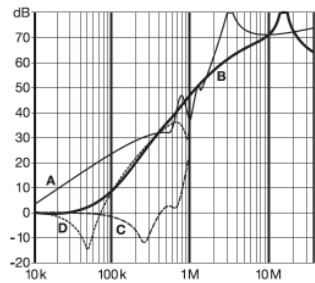

12 A types

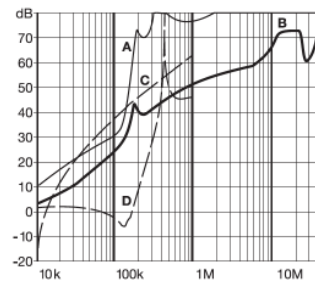

15 A types

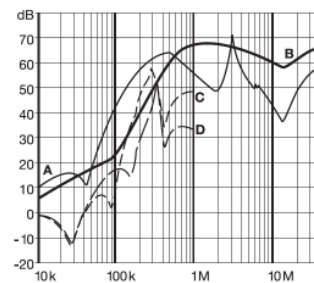

25 A types

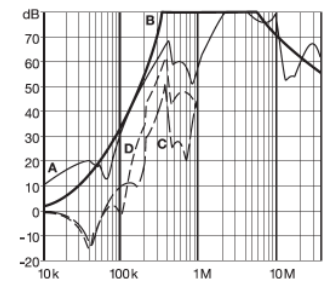

Mechanical data

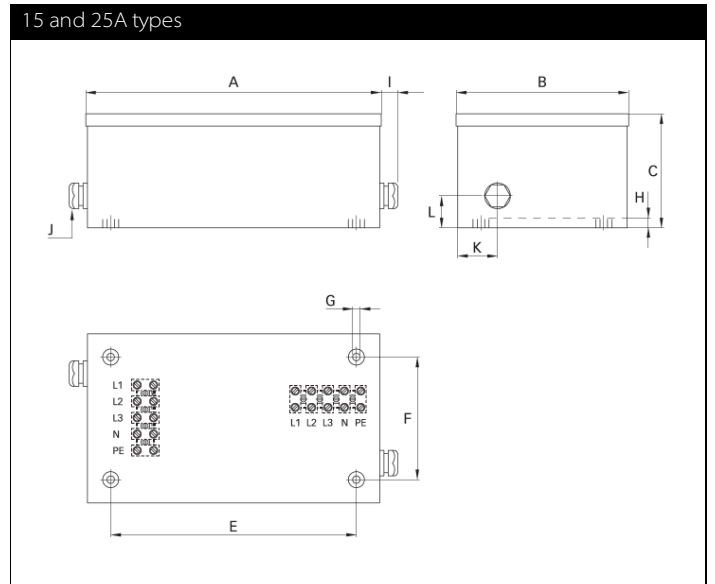
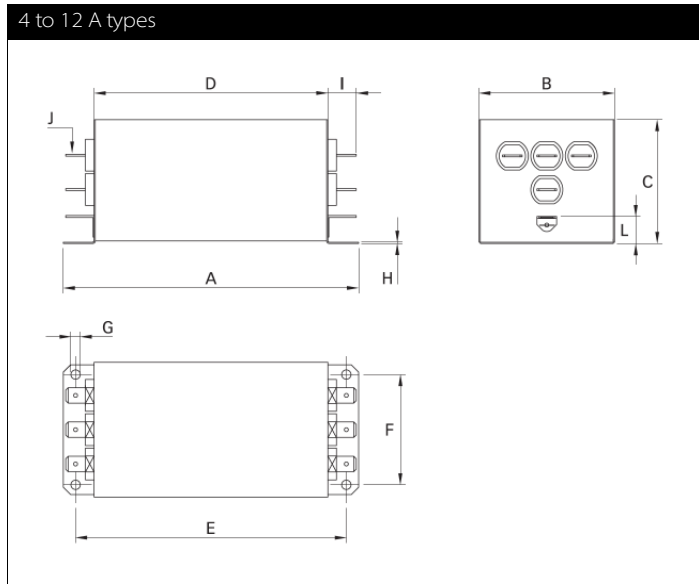

Dimensions

	4 A	6 A	12 A	15 A	25 A
A	103	120	150	273.6	273.6
B	43	55	65	158.6	158.6
C	40.5	50.5	60	107	107
D	80	95	125		
E	95	110	140	230	230
F	35	45	55	115	115
G	Ø3.8	Ø3.8	7.5 x 4.4	M8	M8
H	0.5	0.5	0.75	9.5	9.5
I	11.1	11.1	11.1	~20	~20
J	Faston 6.3 x 0.8	Faston 6.3 x 0.8	Faston 6.3 x 0.8	PG13	PG13
K				35.5	35.5
L	7	11	11	30	30

All dimensions in mm; 1 inch = 25.4 mm
Tolerances according to ISO 2768-m / EN 22768-m

Filter input/output connector cross sections

	-05	-47
Solid wire	n/a	16 mm ²
Flex wire	n/a	10 mm ²
AWG type wire	n/a	AWG 8
Recommended torque	n/a	1.9-2.2 Nm

Please visit www.schaffner.com to find more details on filter connectors.



Headquarters, global innovation and development center

Switzerland

Schaffner Group

Nordstrasse 11
4542 Luterbach
T +41 32 6816 626
F +41 32 6816 630
info@schaffner.com
<http://www.schaffner.com>



Sales and application centers

China

Schaffner EMC Ltd. Shanghai

T20-3, No 565 Chuangye Road
Pudong New Area
201201 Shanghai
T +86 21 3813 9500
F F +86 21 3813 9501 / 02
cschina@schaffner.com
<http://www.schaffner.com.cn/>

Finland

Schaffner Oy

Sauvonrinne 19 H
08500 Lohja
T +358 19 35 72 71
finlandsales@schaffner.com

France

Schaffner EMC S.A.S.

112, Quai de Bezons
Boîte postale 133
95103 Argenteuil
T +33 1 34 34 30 60
F +33 1 39 47 02 28
francesales@schaffner.com

Germany

Schaffner Deutschland GmbH

Schoemperlenstrasse 12B
76185 Karlsruhe
T +49 721 56910
F +49 721 569110
germanysales@schaffner.com

Italy

Schaffner EMC S.r.l.

Via Galileo Galilei 47
20092 Cinisello Balsamo (MI)
T +39 02 66 04 30 45/47
F +39 02 61 23 943
italysales@schaffner.com

Japan

Schaffner EMC K.K.

1-32-12, Kamiyama, Setagaya-ku
7F Mitsui-seimei Sangenjaya Bldg.
154-0011 Tokyo
T +81 3 5712 3650
F +81 3 5712 3651
japansales@schaffner.com
<http://www.schaffner.jp>

Singapore

Schaffner EMC Pte Ltd.

Blk 3015A Ubi Road 1
05-09 Kampong Ubi Industrial Estate
408705 Singapore
T +65 6377 3283
F +65 6377 3281
singaporesales@schaffner.com

Spain

Schaffner EMC España

Edificio E, Alcobendas
El Soto de la Moraleja Alcobendas
28109 Madrid
T +34 618 176 133
spainsales@schaffner.com

Sweden

Schaffner EMC AB

Turebergstorg 1, 6
19147 Sollentuna
T +46 8 5792 1121 / 22
F +46 8 92 96 90
swedensales@schaffner.com

Switzerland

Schaffner EMV AG

Nordstrasse 11
4542 Luterbach
T +41 32 6816 626
F +41 32 6816 641
sales@schaffner.ch

Taiwan R.O.C.

Schaffner EMV Ltd.

6 Floor, No. 413
Rui Guang Road
114 Neihu District Taipei City
T +886 2 87525050
F +886 2 87518086
taiwansales@schaffner.com

Thailand

Schaffner EMC Co. Ltd.

Northern Region Industrial Estate
67 Moo 4 Tambon Ban Klang Amphur Muang
P.O. Box 14
51000 Lamphun
T +66 53 58 11 04
F +66 53 58 10 19
thailandsales@schaffner.com

UK

Schaffner Ltd.

5 Ashville Way
Molly Millars Lane Wokingham
RG41 2PL Berkshire
T +44 118 9770070
F +44 118 9792969
uksales@schaffner.com
<http://www.schaffner.uk.com>

USA

Schaffner EMC Inc.

52 Mayfield Avenue
08837 Edison, New Jersey
T +1 800 367 5566
T +732 225 9533
F +732 225 4789
usasales@schaffner.com
<http://www.schaffner.com/us>

Schaffner MTC LLC

6722 Thirlane Road
24019 Roanoke, Virginia
T +276 228 7943
F +276 228 7953
<http://www.schaffnerusa.com>

Schaffner Trencos LLC

2550 Brookpark Road
44134 Cleveland, Ohio
T +216 741 5282
F +216 741 4860
www.schaffner-trencos.com

To find your local partner within Schaffner's global network, please go to:
www.schaffner.com

© 2014 Schaffner Group

The content of this document has been carefully checked and understood. However, neither Schaffner nor its subsidiaries assume any liability whatsoever for any errors or inaccuracies of this document and the consequences thereof. Published specifications are subject to change without notice. Product suitability for any area of application must ultimately be determined by the customer. In all cases, products must never be operated outside their published specifications. Schaffner does not guarantee the availability of all published products. This disclaimer shall be governed by substantive Swiss law and resulting disputes shall be settled by the courts at the place of business of Schaffner Holding AG. Latest publications and a complete disclaimer can be downloaded from the Schaffner website. All trademarks recognized.