

Ecosine evo, 50 Hz Passive Harmonic Filters

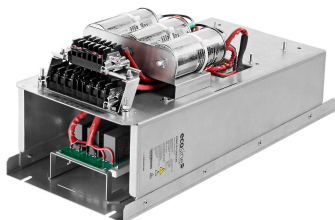

- The industry standard for 6-pulse rectifier and motor drives
- Filters for diode rectifier with DC-link choke
- Best-in-class partial load performance
- Most compact design
- Plug and play, ready to use



Approvals



(depending on filter configuration)

UL pending for 315 kW types

Features and benefits

Schaffner ecosine harmonic filters represent an economical solution to the challenge of load-applied harmonics mitigation in three-phase power systems. With a plug-and-play approach and more compact dimensions than comparable products, they can be quickly installed and easily commissioned. They increase the reliability and service life of electric installations, help utilize electric system capacity better, and are the key to meet Power Quality standards such as IEEE 519. Ecosine filters reshape your distorted current back to the desired sinusoidal waveform. Schaffner ecosine filters can be applied to virtually any kind of power electronics with front-end six-pulse rectifiers, 3-phase diode or thyristor bridges, where harmonic current distortion needs to be reduced to defined limits.

Technical specifications

Nominal operating voltage	3 x 440 VAC to 500 VAC ±10%
Operating frequency	50 Hz ±1 Hz
Nominal motor drive input power rating	1.1 to 315 kW
Total harmonic current distortion THID*	≤5% at rated power
Efficiency	>98% for rated voltage and power
High potential test voltage	P → E 2160 VAC (1 s)
Protection category	IP 00, IP 20
Cooling	Internal fan cooling or external cooling**
Overload capability	1.6x rated current for 1 minute, once per hour
Ambient temperature range	-25°C to +45°C fully operational -25°C to +85°C transport and storage +45°C to +70°C derated operation***
Flammability corresponding to	UL 94 V-2
Design corresponding to	Filter: UL 61800-5-1, EN 61800-5-1 Chokes: EN 61558-2-20 or EN 60076-6
MTBF @ 45°C/415 V (Mil-HB-217F)	>200,000 hours
SCCR****	100 kA
Earthing System	TN, TT, IT
Overvoltage category	OV III (IEC 60664-1 / UL 61800-5-1)

* System requirements: THVD <2%, line voltage unbalance <1%
 Note: performance specifications in this brochure refer to six-pulse diode rectifiers with 8% DC-link choke. THID ~5% at rated power for filter <6 kW
 ** Please check the inlet air flow required for cooling table on page 6 of this document.
 *** $I_{derated} = I_{nominal} \cdot \sqrt{\frac{(T_{max} - T_{amb})}{(T_{max} - T_{nominal})}} = I_{nom} \cdot \sqrt{\frac{(70^\circ\text{C} - T_{amb})}{25^\circ\text{C}}}$
 **** External UL-rated fuses required. Please consult the user manual.

Typical applications

- Equipment with front-end six-pulse rectifier
- Motor drives
- Factory automation equipment
- Water/wastewater treatment facilities
- Fan and pump applications
- HVAC installations
- Mission-critical processes
- DC fast chargers

Typical electrical schematic

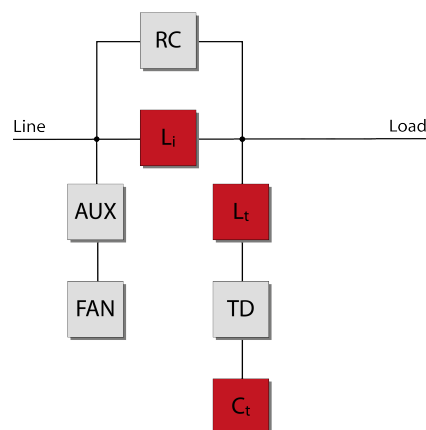

(all configurable optional functionalities shown)

Filter selection table – IP 00 enclosure

Filter	Rated load power @ 480 VAC/50 Hz [kW]	Motor drive input current [Arms]**	Rated filter input current [Arms]	Min. required L _{DC} [mH]*****	Min. required L _{AC} [mH]*****	Weight [kg]	Typical losses [W]****	Terminal	Frame size
FN 3451-1-110-E0_*****	1.1	1.4	1.3	53.87	16.70	5	40	110	A
FN 3451-2-110-E0_*****	2.2	2.8	2.7	26.94	7.85	7	61	110	A
FN 3451-4-112-E0_*****	4	5.1	4.9	14.82	4.47	10	104	112	B
FN 3451-6-112-E0_*****	5.5	7.1	6.7	10.78	3.48	12	104	112	B
FN 3451-8-112-E0_*****	7.5	9.6	9.2	7.90	2.55	15	143	112	C
FN 3451-11-112-E0_*****	11	14.1	13.4	5.39	1.82	17	193	112	C
FN 3451-15-113-E0_****	15	19.3	18.3	3.95	1.26	24	233	113	D
FN 3451-19-113-E0_****	19	24.4	23	3.12	1.02	27	292	113	D
FN 3451-22-113-E0_****	22	28	27	2.69	0.88	31	274	113	D
FN 3451-30-115-E0_****	30	38.5	36.6	1.98	0.64	38	355	115	E
FN 3451-37-115-E0_****	37	47.5	45	1.60	0.527	43	426	115	E
FN 3451-45-115-E0_****	45	58	55	1.32	0.451	49	458	115	E
FN 3451-55-115-E0_****	55	71	67	1.08	0.357	54	611	115	F
FN 3451-75-115-E0_****	75	97	92	0.79	0.265	70	781	115	F
FN 3451-90-116-E0_****	90	116	110	0.66	0.218	100	740	116	G
FN 3451-110-116-E0_****	110	142	135	0.54	0.176	108	799	116	G
FN 3451-132-118-E0_****	132	170	162	0.45	0.149	130	1063	118	H
FN 3451-160-118-E0_******	160	207	197	0.37	0.118	149	1039	118	H
FN 3451-200-118-E0_******	200	259	246	0.30	0.094	183	1232	118	H
FN 3451-250-118-E0_******	250	324	308	0.24	0.073	221	1262	118	H
New									
FN 3451-315-119-E0XXSXX	315	410	392	0.188	0.059	252	1553	119	J

* Filter rating which does not require forced cooling or fan module

** Filter rating which does not require RC damping module for rectifiers with EMI filter

*** Motor drive input current without harmonic filter

**** Typical losses @ 45°C, 480V, 50Hz and rated load power

***** In order to apply FN 3451 filters, motor drives have to be equipped with either DC-link choke or AC line choke. The minimum required inductance values are given in mH in the filter selection table. If neither DC-link choke nor AC line choke is present, or if the minimum mH rating is not fulfilled, FN 3451 filter must not be used. In this case, FN 3450 need to be chosen.

Filter power terminals

Terminal designation*	Screw thread	Flex wire AWG	Flex wire [mm ²]	Screw torque value [Nm]	Max width** cable lug [mm]	Frame size
110	M3	14-22	0.4-2.5	0.5	7	A
112	M4	10-22	0.4-6	1.2	10	B, C
113	M6	6-18	0.75-16	3	15	D
115	M8	1/0-8	10-50	8	15	E, F
116	M8	3/0-8	10-95	8	17	G
118	M10	3/0-500 kcmil	95-240	10	35	H
119	M16	350-750 kcmil	185-400	10	48	J

* Recommended connector type: wire or cable lug for 110 to 113, only cable lug for 115 to 118

** To fulfill creepage/clearance acc. UL 61800-5-1 without additional protection (insulation). Creepage/clearance can vary depending on applicable standard and must be reviewed by customer. Creepage/clearance may be reduced when additional protection (insulation) is provided.

Filter signal and earth terminals

Terminal type	Screw thread	Screw torque value [Nm]	Frame size
Signal	M3*	0.5	All
Earth (PE)	M5	2.2	A
Earth (PE)	M6	4	B, C
Earth (PE)	M8	9	D, E
Earth (PE)	M10	17	F, G, H
Earth (PE)	M12	25	J

* Max width cable lug = 7 mm

Filter selection table – IP 20 enclosure

Filter	Rated load power @ 400 V/50 Hz [kW]	Motor drive input current [Arms]**	Rated filter input current [Arms]	Min. required LDC [mH]*****	Min. required LAC [mH]*****	Weight [kg]	Typical losses [W]****	Terminal	Frame size
FN 3451-1-110-E2_*****	1.1	1.4	1.3	53.87	16.70	6	40	110	A
FN 3451-2-110-E2_*****	2.2	2.8	2.7	26.94	7.85	8	61	110	A
FN 3451-4-112-E2_*****	4	5.1	4.9	14.82	4.47	11	104	112	B
FN 3451-6-112-E2_*****	5.5	7.1	6.7	10.78	3.48	13	104	112	B
FN 3451-8-112-E2_*****	7.5	9.6	9.2	7.90	2.55	16	143	112	C
FN 3451-11-113-E2_****	11	14.1	13.4	5.39	1.82	19	193	112	C
FN 3451-15-113-E2_****	15	19.3	18.3	3.95	1.26	28	233	113	D
FN 3451-19-113-E2_****	19	24.4	23	3.12	1.02	30	292	113	D
FN 3451-22-115-E2_****	22	28	27	2.69	0.88	34	274	113	D
FN 3451-30-115-E2_****	30	38.5	36.6	1.98	0.64	44	355	115	E
FN 3451-37-115-E2_****	37	47.5	45	1.60	0.527	49	426	115	E
FN 3451-45-115-E2_****	45	58	55	1.32	0.451	55	458	115	E
FN 3451-55-115-E2_****	55	71	67	1.08	0.357	62	611	115	F
FN 3451-75-116-E2_****	75	97	92	0.79	0.265	77	781	115	F
FN 3451-90-116-E2_****	90	116	110	0.66	0.218	109	740	116	G
FN 3451-110-118-E2_****	110	142	135	0.54	0.176	117	799	116	G
FN 3451-132-118-E2_****	132	170	162	0.45	0.149	147	1063	118	H
FN 3451-160-118-E2_******	160	207	197	0.37	0.118	166	1039	118	H
FN 3451-200-118-E2_******	200	259	246	0.30	0.094	200	1232	118	H
FN 3451-200-118-E2E2_******	250	324	308	0.24	0.073	238	1262	118	H
New									
FN 3451-315-119-E2FASXX	315	410	392	0.188	0.059	278	1553	119	J

* Filter rating which does not require forced cooling or fan module

** Filter rating which does not require RC damping module for rectifiers with EMI filter

*** Motor drive input current without harmonic filter

**** Typical losses @ 45°C, 400V, 50Hz and rated load power

***** **In order to apply FN 3451 filters, motor drives have to be equipped with either DC-link choke or AC line choke. The minimum required inductance values are given in mH in the filter selection table. If neither DC-link choke nor AC line choke is present, or if the minimum mH rating is not fulfilled, FN 3451 filter must not be used. In this case, FN 3450 need to be chosen.**

Filter power terminals

Terminal designation*	Screw thread	Flex wire AWG	Flex wire	Screw torque value	Max width**	Frame size
			[mm ²]		cable lug	
				[Nm]	[mm]	
110	M3	14-22	0.4-2.5	0.5	7	A
112	M4	10-22	0.4-6	1.2	10	B, C
113	M6	6-18	0.75-16	3	15	D
115	M8	1/0-8	10-50	8	15	E, F
116	M8	3/0-8	10-95	8	17	G
118	M10	3/0-500 kcmil	95-240	10	35	H
119	M16	350-750 kcmil	185-400	10	48	J

* Recommended connector type: wire or cable lug for 110 to 113, only cable lug for 115 to 118

** To fulfill creepage/clearance acc. UL 61800-5-1 without additional protection (insulation). Creepage/clearance can vary depending on applicable standard and must be reviewed by customer. Creepage/clearance may be reduced when additional protection (insulation) is provided.

Filter signal and earth terminals

Terminal type	Screw thread	Screw torque value	Frame size
		[Nm]	
Signal	M3*	0.5	All
Earth (PE)	M5	2.2	A
Earth (PE)	M6	4	B, C
Earth (PE)	M8	9	D, E
Earth (PE)	M10	17	F, G, H
Earth (PE)	M12	25	J

* Max width cable lug = 7 mm

Product selector

FN 34nn-xxx-yyy-

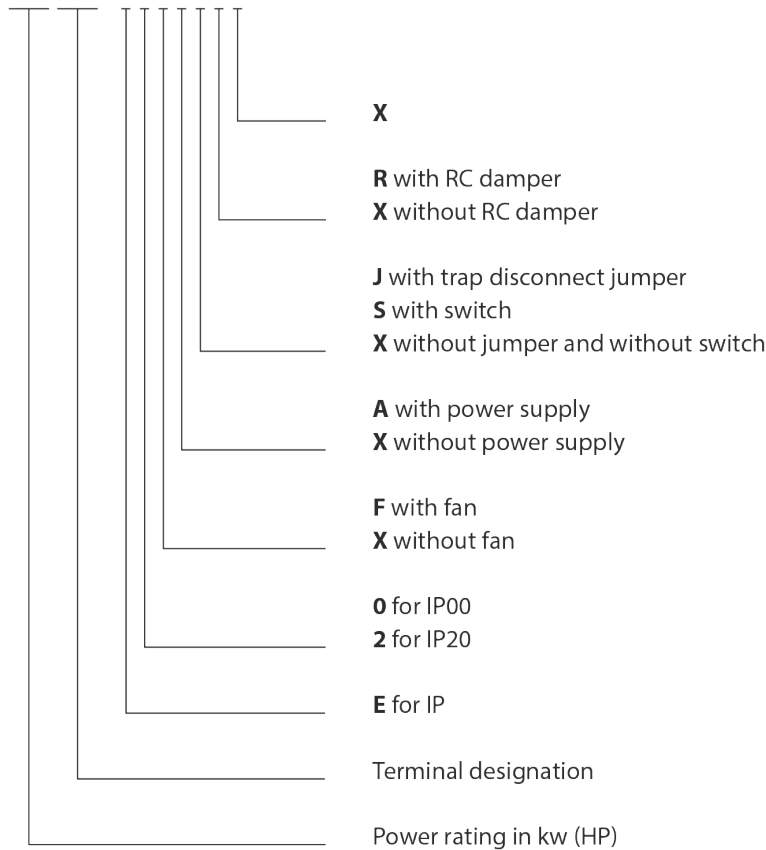
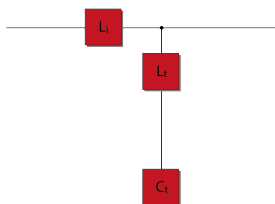

Table 1: Filter configurations if external air flow is available for cooling

(Filters do **not** contain fan and do **not** contain aux. power supply)

E0XXXXX

- For rectifiers with DC-link choke



E0XXJXX

- For rectifiers with DC-link choke

- Filters contain trap disconnect jumper

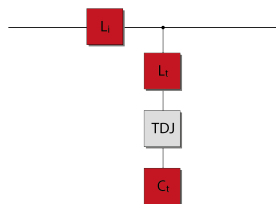

E0XXRX

- For rectifiers with DC-link choke and with EMI filter

- Filters contain RC damper module

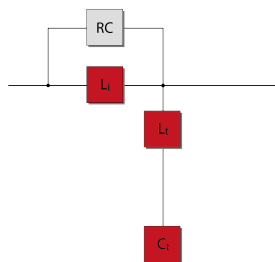

E0XXJRX

- For rectifiers with DC-link choke and with EMI filter

- Filters contain RC damper module and trap disconnect jumper

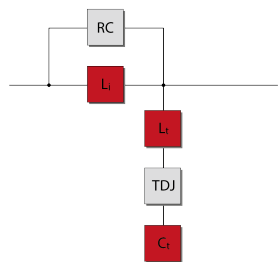
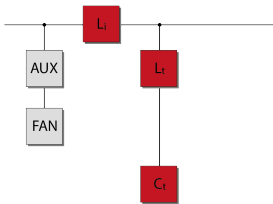

Table 2: Filter configurations with embedded ventilation

(Filters contain fan and aux. power supply)

E0FAXXX and E2FAXXX

- For rectifiers with DC-link choke
- Filters contain fan and aux. power supply



E0FAJXX and E2FAJXX

- For rectifiers with DC-link choke
- Filters contain fan, aux. power supply and trap disconnect jumper

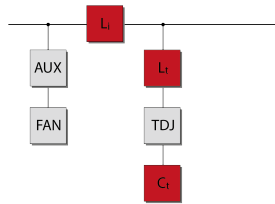

E0FAXRX and E2FAXRX

- For rectifiers with DC-link choke and with EMI filter
- Filters contain fan, aux. power supply and RC damper module

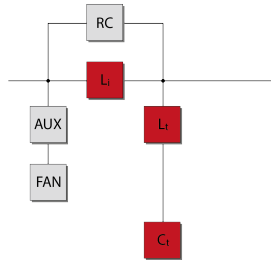

E0FAJRX and E2FAJRX

- For rectifiers with DC-link choke and with EMI filter
- Filters contain fan, aux. power supply, RC damper module and trap disconnect jumper

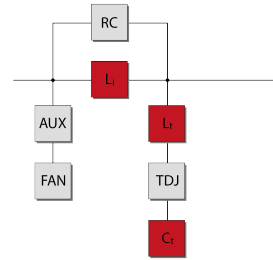
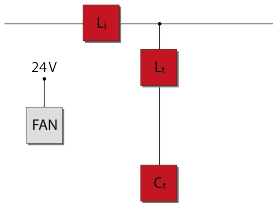

Table 3: Filter configurations if external aux. power supply for the fan is available

(Filters contain fan but do not contain aux. power supply, user should provide aux. power supply to the fan)

E0FXXXX and E2FXXXX

- For rectifiers with DC-link choke
- Filters contain fan



E0FXJXX and E2FXJXX

- For rectifiers with DC-link choke
- Filters contain fan and trap disconnect jumper

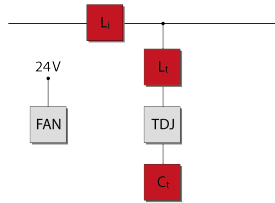

E0FXRX and E2FXRX

- For rectifiers with DC-link choke and with EMI filter
- Filters contain fan and RC damper module

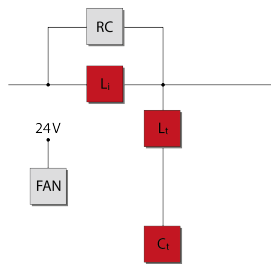

E0FXJRX and E2FXJRX

- For rectifiers with DC-link choke and with EMI filter
- Filters contain fan, RC damper module and trap disconnect jumper

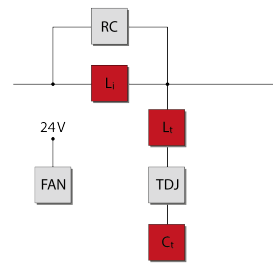
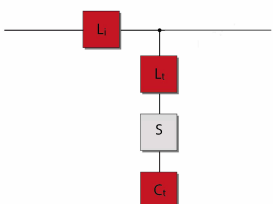

Table 4: 315 kW Filter configuration

E0XXSXX

- For rectifiers with DC-link choke
- Filters contain circuit breaker



E2FASXX

- For rectifiers with DC-link choke
- Filters contain fan aux. power supply and circuit breaker

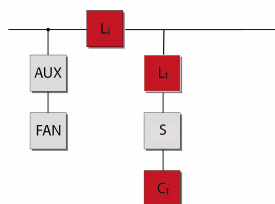

Mechanical data of IP 00 enclosure

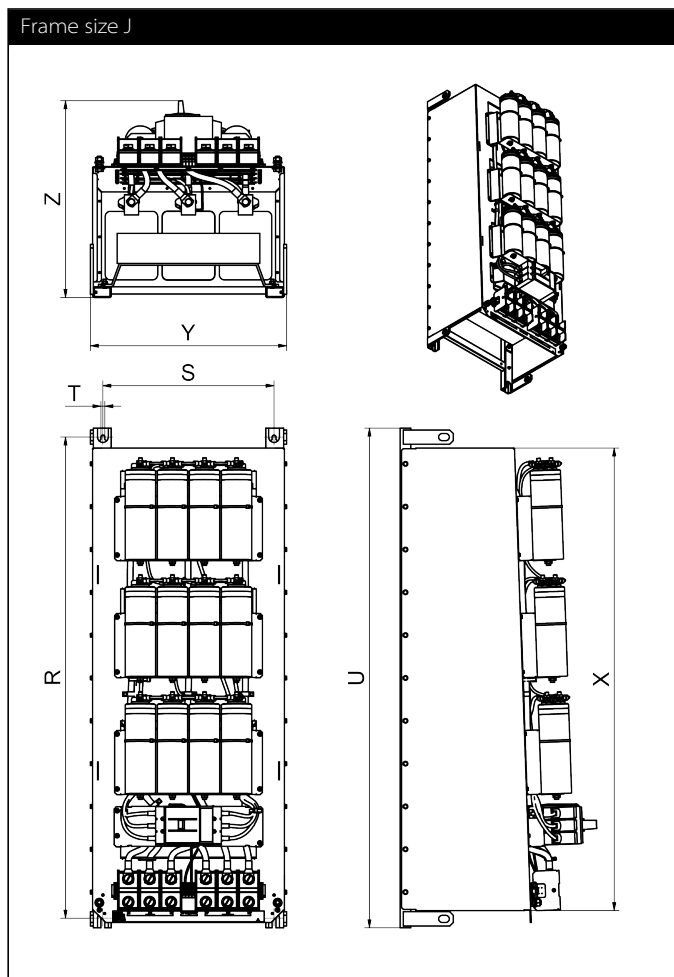
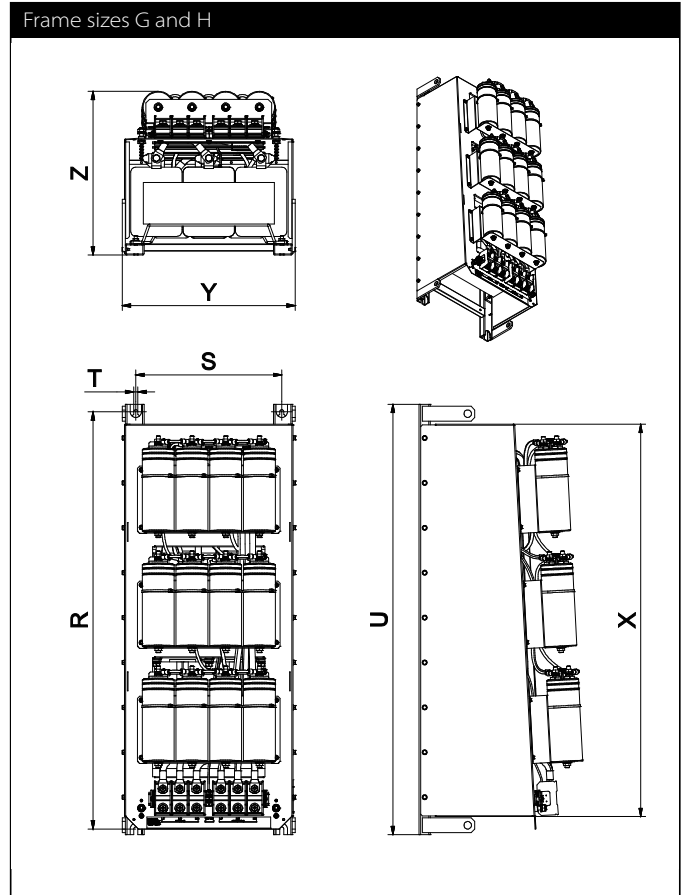
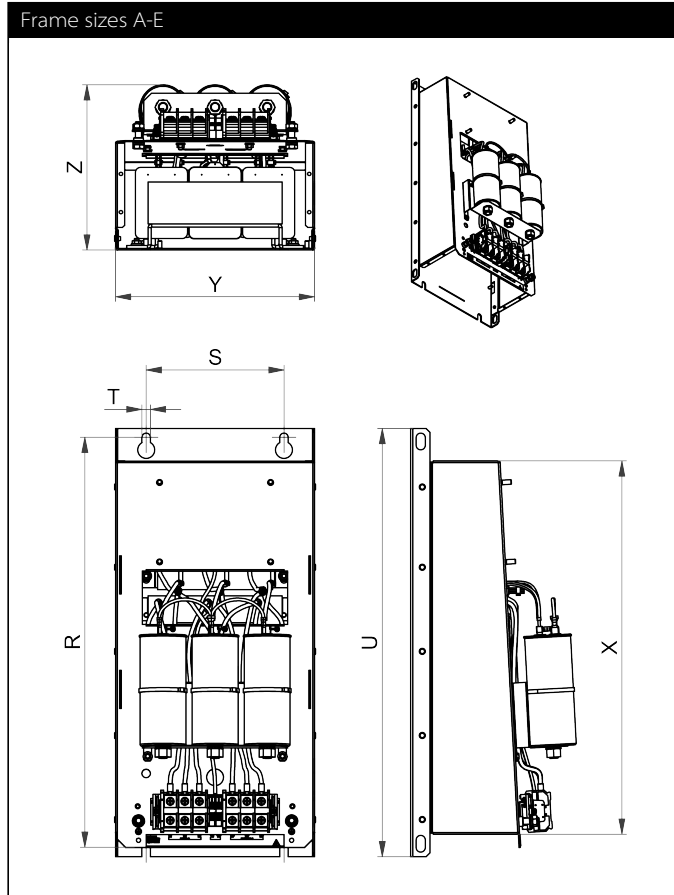

Dimensions

Frame	Drill pattern [mm]			Base [mm]			Volume [mm]	
	R	S	T	U	X	Y	Z	V
A	340	120	7	360	302	160	185	
B	405	120	7	425	370	180	206	
C	460	150	7	483	430	210	221	
D	540	180	11	560	491	260	252	
E	680	220	11	705	635	290	319	
F	730	250	11	752	684	340	343	
G	920	280	11	960	863	353	386	
H	115	390	11	1150	1053	462	456	
J	1348	480	11	1400	1300	550	555	1455

Inlet air flow required for cooling

Frame size	Min air volume* [m ³ /h]
A, B, C	0
D	128
E	204
G	408
H	612
J	816

* External air flow required for filter configurations without embedded ventilation

Mechanical data of IP 20 enclosure

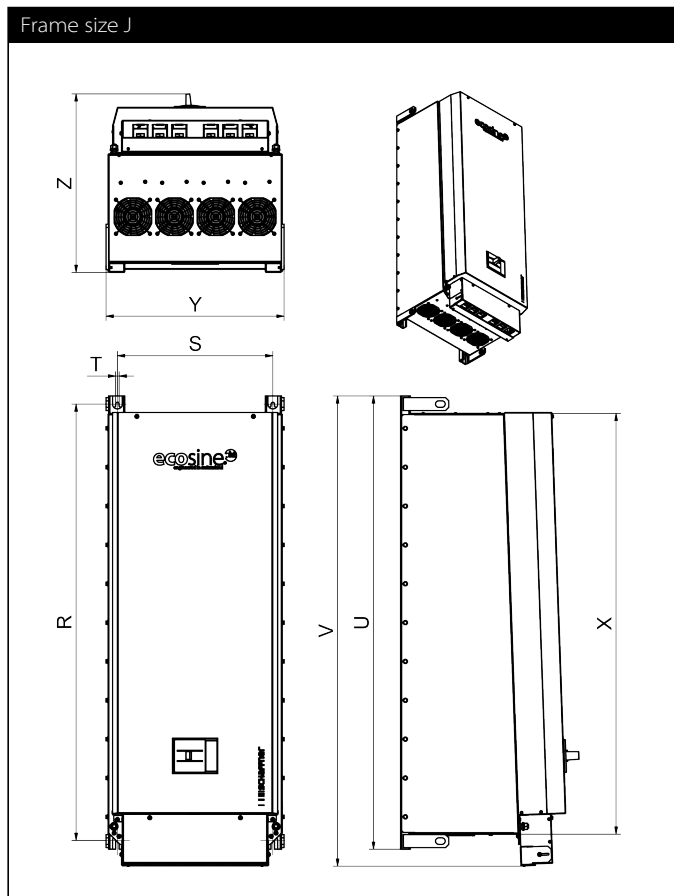
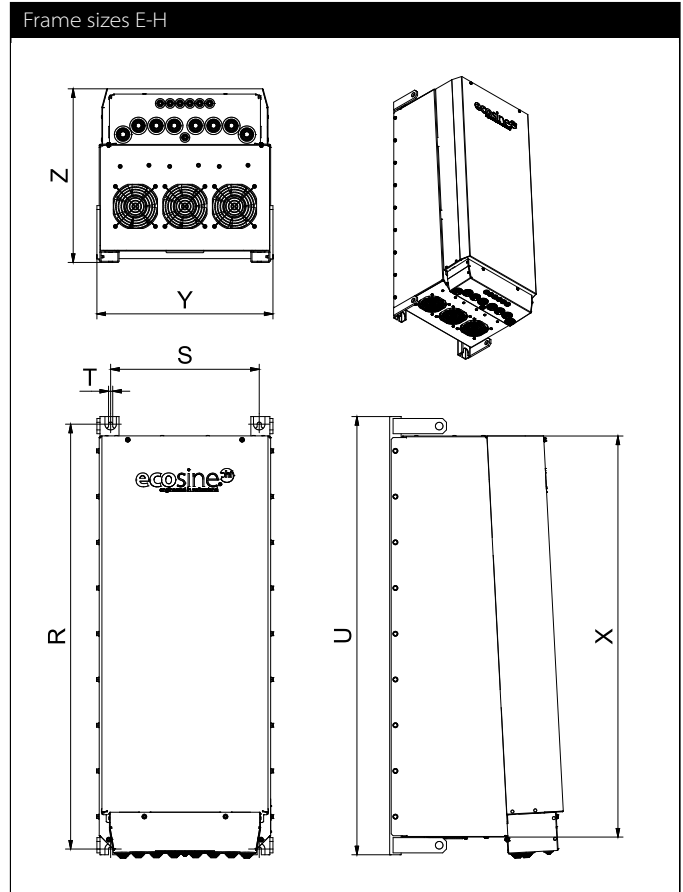
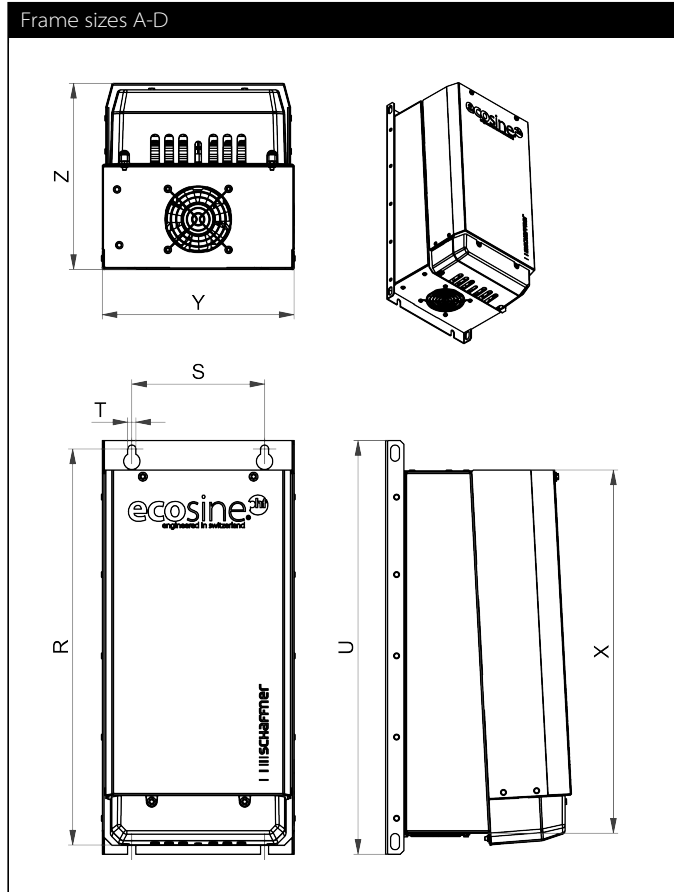

Dimensions

Frame	Drill pattern [mm]			Base [mm]			Volume [mm]	
	R	S	T	U	X	Y	Z	V
A	340	120	7	360	302	160	185	
B	405	120	7	425	370	180	206	
C	460	150	7	483	430	210	221	
D	540	180	11	560	491	260	252	
E	680	220	11	705	635	290	319	
F	730	250	11	752	684	340	343	
G	920	280	11	960	863	353	386	
H	115	390	11	1150	1053	462	456	
J	1348	480	11	1400	1300	550	555	1455

Inlet air flow required for cooling

Frame size	Min air volume* [m ³ /h]
A, B, C	0
D	128
E	204
G	408
H	612
J	816

* External air flow required for filter configurations without embedded ventilation



Headquarters, global innovation and development

Switzerland

Schaffner Group

Industrie Nord
Nordstrasse 11e
4542 Luterbach
T +41 32 681 66 26
info@schaffner.com



Sales and application centers

China

Schaffner EMC Ltd. Shanghai

T20-3 C, No 565 Chuangye Road,
Pudong district
201201 Shanghai
T +86 21 3813 9500
cschina@schaffner.com
www.schaffner.com.cn

Finland

Schaffner Oy

Sauvonrinne 19 H
08500 Lohja
T +358 10 567 2855
finlandsales@schaffner.com

France

Schaffner EMC S.A.S.

16-20 Rue Louis Rameau
95875 Bezons
T +33 1 34 34 30 60
F +33 1 39 47 02 28
francesales@schaffner.com

Germany

Schaffner Deutschland GmbH

Schoemperlenstrasse 12B
76185 Karlsruhe
T +49 721 56910
F +49 721 569110
germanysales@schaffner.com

India

Schaffner India Pvt. Ltd

REGUS WORLD TRADE CENTRE
WTC, 22nd Floor Unit No 2238, Brigade
Gateway Campus, 26/1, Dr. Rajkumar Road
Malleshwaram (W)
560055 Bangalore
T +91 80 67935355
indiasales@schaffner.com

Italy

Schaffner EMC S.r.l.

Via Ticino, 30
20900 Monza (MB)
T +39 039 21 41 070
italysales@schaffner.com

Japan

Schaffner EMC K.K.

Taiju-Seimei Sangenjaya Bldg.
1-32-12, Kamiuma, Setagaya-ku
154-0011 Tokyo
T +81 3 5712 3650
F +81 3 5712 3651
japansales@schaffner.com
www.schaffner.jp

Singapore

Schaffner EMC Pte Ltd.

#05-09, Kg Ubi Ind. Estate
408705 Singapore
T +65 6377 3283
F +65 6377 3281
singaporesales@schaffner.com

Spain

Schaffner EMC España

Calle Caléndula 93, Miniparc III, Edificio E
El Soto de Moraleja, Alcobendas
28109 Madrid
T +34 917 912 900
F +34 917 912 901
spainsales@schaffner.com

Sweden

Schaffner EMC AB

Östermalmstorg 1
114 42 Stockholm
T +46 8 5050 2425
swedensales@schaffner.com
www.schaffner.com

Switzerland

Schaffner EMV AG

Industrie Nord
Nordstrasse 11e
4542 Luterbach
T +41 32 681 66 26
switzerlandsales@schaffner.com

Taiwan R.O.C.

Schaffner EMV Ltd.

20 Floor-2, No 97, Section 1, XinTai 5th Road
22175 XiZhi District New Taipei City 22175
T +886 2 2697 5500
F +886 2 2697 5533
taiwansales@schaffner.com
www.schaffner.com.tw

Thailand

Schaffner EMC Co. Ltd.

Northern Region Industrial Estate
67 Moo 4 Tambon Ban Klang
Amphur Muangng P.O. Box 14
51000 Lamphun
T +66 53 58 11 04
F +66 53 58 10 19
thailandsales@schaffner.com

United Kingdom

Schaffner Ltd.

5 Ashville Way, Molly Millars Lane
Wokingham
RG41 2PL Berkshire
T +44 118 9770070
F +44 118 9792969
uksales@schaffner.com

USA

Schaffner EMC Inc.

52 Mayfield Avenue
Edison, New Jersey
T +1 732 225 9533
F +1 732 225 4789
usasales@schaffner.com
www.schaffnerusa.com

Schaffner North America

6722 Thirlane Road
24019 Roanoke, Virginia
T +1 276 228 7943
F +1 276 228 7953

Schaffner North America

823 Fairview Road
24382 Wytheville, Virginia
T +1 276 228 7943
F +1 276 228 7258

To find your local partner within Schaffner's global network: www.schaffner.com

© 2018 Schaffner Group

The content of this document has been carefully checked and understood. However, neither Schaffner nor its subsidiaries assume any liability whatsoever for any errors or inaccuracies of this document and the consequences thereof. Published specifications are subject to change without notice. Product suitability for any area of application must ultimately be determined by the customer. In all cases, products must never be operated outside their published specifications. Schaffner does not guarantee the availability of all published products. This disclaimer shall be governed by substantive Swiss law and resulting disputes shall be settled by the courts at the place of business of Schaffner Holding AG. Latest publications and a complete disclaimer can be downloaded from the Schaffner website. All trademarks recognized.