

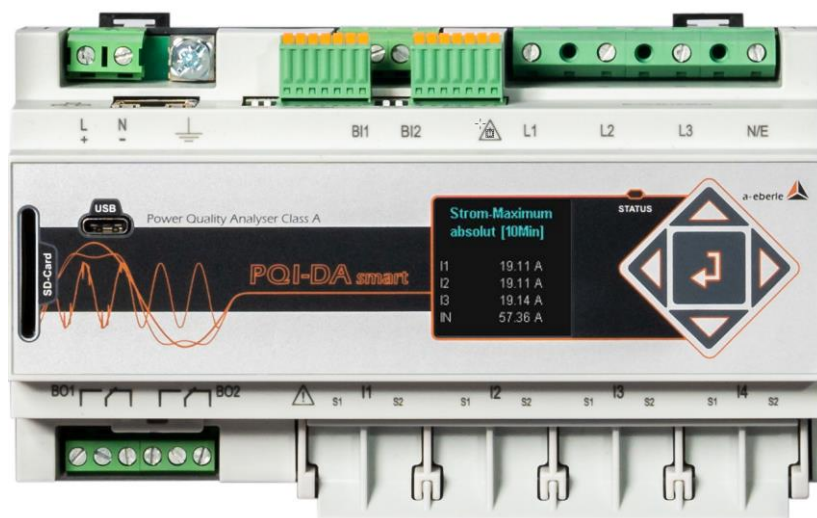

# User Manual

## Power Quality Network Analyser Model PQI-DA *smart*

Power-Quality Evaluation Software WinPQ *lite*





**Note:**

Please note that these operating instructions may not always contain the latest information concerning the device. If, for example, you have changed the firmware of the device to a higher version via the Internet, this description will no longer be completely accurate.

In this case, contact us directly or use the latest version of the operating instructions available from our Internet site ([www.a-eberle.de](http://www.a-eberle.de)).

**A. Eberle GmbH & Co KG**

Frankenstraße 160

D-90461 Nuremberg

Telephone: 0911 / 62 81 08 0

Fax: 0911 / 62 81 08 99

E-Mail: info@a-eberle.de

Internet: www.a-eberle.de

**A. Eberle GmbH & Co KG** does not accept any liability for damage or losses of any kind arising from printing errors or changes in this manual.

Furthermore, **A. Eberle GmbH & Co KG** will not accept any liability for loss or damage of any kind resulting from faulty equipment or devices that have been modified by the user.

**Copyright 2019 A. Eberle GmbH & Co KG**

Subject to change without prior notice.

# Table of Contents

<b>1.</b>	<b>User prompt .....</b>	<b>7</b>
1.1	Target group.....	7
1.2	Warnings .....	7
1.3	Tips .....	8
1.4	Other symbols.....	8
1.5	Applicable documentation.....	8
1.6	Keeping .....	8
<b>2.</b>	<b>Scope of Delivery/Order Codes .....</b>	<b>9</b>
2.1	Scope of Delivery .....	9
2.2	Order Codes .....	9
<b>3.</b>	<b>Safety instructions .....</b>	<b>11</b>
3.1	Meaning of the symbols used on the device .....	12
3.1.1	Site information and assembly instructions of PQI-DA <i>smart</i> .....	12
<b>4.</b>	<b>Intended use .....</b>	<b>12</b>
<b>5.</b>	<b>Technical Data .....</b>	<b>13</b>
5.1	PQI-DA <i>smart</i> Description .....	13
5.2	Technical Data.....	15
5.2.1	Voltage Inputs.....	16
5.2.2	Current inputs.....	17
5.2.3	Binary inputs – binary outputs.....	18
5.2.4	Power supply for PQI-DA <i>smart</i> .....	19
5.2.5	Storage of measured values.....	20
5.2.6	Communication protocols.....	20
5.2.7	Time synchronization interface .....	20
5.2.8	Other interfaces .....	20
5.2.9	Electrical safety – environmental parameter .....	21
5.3	Mechanical design .....	22
5.3.1	Battery.....	23
5.4	Terminal strip number PQI-DA <i>smart</i> .....	24
5.5	Supply voltage connection.....	25
5.6	Mains connection for PQI-DA <i>smart</i> .....	27
5.6.1	3-phase / 4-wire connection .....	27
5.6.2	4-wire connection without neutral current.....	29
5.6.3	4-wire 1-phase .....	31

5.6.4	3-phase / 3-wire connection.....	33
5.6.5	Low-level signal inputs for current measurement (Features C40 ... C45) .....	37
5.6.6	DC mains connection .....	39
5.7	Additional Interfaces.....	41
5.7.1	RS232 / RS485 Interfaces.....	41
5.7.2	Output relays .....	43
5.7.3	Binary Inputs.....	44
5.8	Measurement / Functions .....	45
5.8.1	Continuous Recording:.....	45
5.8.2	PQ Events.....	48
5.8.3	Recorder triggering.....	48
5.8.4	Memory management.....	49
<b>6.</b>	<b>Operation of the PQI-DA <i>smart</i> .....</b>	<b>51</b>
6.1	Getting started.....	51
6.2	Initial Setup - Operation of the Assistant.....	51
6.3	First commissioning - wizard - procedure.....	52
6.4	Display.....	56
6.5	Setup display.....	61
6.5.1	Parameter .....	61
6.5.2	Time settings.....	64
6.5.3	Basic setting.....	72
6.5.4	Password lock device display.....	73
6.5.5	Memory management.....	74
6.5.6	Setting up the device interfaces .....	74
<b>7.</b>	<b>WinPQ lite Software .....</b>	<b>75</b>
7.1	Installing the evaluation software .....	75
7.2	Basic setting for Software .....	77
7.3	Setting up a new PQI-DA <i>smart</i> .....	78
7.3.1	Creating a device tile .....	78
7.3.2	Completing the Instrument Wizard in Safety Mode.....	81
7.3.3	Deleting a device tile.....	84
7.4	Device setup.....	84
7.4.1	Main Menu: Views and functions.....	85
7.4.2	Parameter Menu: Device parameters and settings.....	86
7.4.3	Basic Settings .....	87
7.4.4	Limits.....	89

7.4.5	Oscilloscope Recorder.....	90
7.4.6	RMS Recorder .....	94
7.4.7	Ripple Control .....	95
7.4.8	Time settings.....	95
7.5	Device setup Expert View .....	99
7.5.1	Device designations .....	99
7.5.2	Thresholds and Recording.....	100
7.5.3	Recordings parameter.....	109
7.6	Online measurement values .....	111
7.6.1	Measurement values .....	111
7.6.2	Vector diagram.....	112
7.6.3	Oscilloscope image.....	112
7.6.4	Online spectrum FFT-Analyse .....	113
7.6.5	Harmonic.....	114
7.6.6	Interharmonic .....	115
7.6.7	Frequency bands from 2kHz to 9kHz .....	116
7.6.8	Device panel.....	117
7.6.9	Software trigger .....	117
7.7	Measurement data import .....	118
7.8	Deleting measurement data in the device memory .....	122
7.9	Evaluating measurement data offline.....	123
7.9.1	Edit measurement data .....	124
7.9.2	EN50160 report.....	126
7.9.3	Voltage harmonics and interharmonics.....	126
7.9.4	Current harmonics and interharmonics.....	127
7.10	Importing measurement data from an SD card .....	129
<b>8.</b>	<b>Online Diagnostic .....</b>	<b>130</b>
<b>9.</b>	<b>User database and access rights .....</b>	<b>131</b>
9.1	Adding and Editing Users .....	132
9.2	IT security settings and password requirements.....	133
<b>10.</b>	<b>Firmware update for PQI-DA <i>smart</i>.....</b>	<b>135</b>
10.1	Firmware update with software WinPQ lite .....	135
10.2	Firmware update with SD - card .....	136
10.3	Automatic Firmware Update of Many Devices.....	137
<b>11.</b>	<b>Calibration PQI-DA <i>smart</i> (license required) .....</b>	<b>138</b>
11.1	Requirements for calibration equipment .....	138

11.2	Calibration process with the WinPQ lite software .....	138
11.2.1	Steps of calibration .....	139
11.2.2	Creation of the calibration test report certificate .....	142
<b>12.</b>	<b>License Update PQI-DA <i>smart</i> .....</b>	<b>143</b>
<b>13.</b>	<b>SCADA.....</b>	<b>144</b>
13.1	Modbus .....	144
13.1.1	Modbus data list .....	144
13.1.2	Modbus settings .....	145
13.1.3	Modbus RTU .....	145
13.1.4	Modbus TCP.....	146
13.1.5	Set-up parameter Modbus with WinPQ.....	146
13.2	IEC60870-104.....	152
13.2.1	IEC60870-104 Data point.....	152
13.2.2	IEC60870-104 Settings in WinPQ lite.....	152
13.3	IEC61850 .....	154
13.3.1	Display settings IEC61850 .....	154
13.3.2	IEC61850 Data Points.....	154
13.3.3	IEC61850 settings in WinPQ lite .....	155
<b>14.</b>	<b>Measurement methods PQI-DA <i>smart</i>.....</b>	<b>156</b>
<b>15.</b>	<b>Service .....</b>	<b>165</b>
<b>16.</b>	<b>Disposal .....</b>	<b>166</b>
<b>17.</b>	<b>Product Warranty.....</b>	<b>167</b>

# 1. User prompt

The user manual contains all important information for installation, commissioning and operation. Read the instruction manual completely and do not use the product until you have understood the instruction manual.

## 1.1 Target group

These operating instructions are intended for trained and qualified staff as well as trained and tested operators. The contents of these operating instructions must be made accessible to the persons responsible for installing and operating the system.

## 1.2 Warnings

### ▶ Structure of the warnings

 <b>SIGNAL WORD</b>	<b>Type and source of danger!</b> Consequences of non-observance ➔ Action to avoid the danger.
---	--

### ▶ Types of warnings

Warnings differ according to the type of danger as follows:

 <b>DANGER!</b>	Warns of an imminent danger which, if not avoided, will result in death or serious injury.
---	--

 <b>WARNING!</b>	Warns of a potentially dangerous situation that can result in death or serious injuries when not avoided.
--	---

 <b>CAUTION!</b>	Warns of a potentially dangerous situation that can result in fairly serious or minor injuries when not avoided.
--	--

<b>NOTICE!</b>	Warns of a potentially dangerous situation that if not avoided could result in material or environmental damage.
----------------	--

## 1.3 Tips



Notes on appropriate use of the device.

## 1.4 Other symbols

### Instructions

Structure of the instructions:

- ➞ Guidance for an action.
- ↪ Indication of an outcome, if necessary.

### Lists

Structure of unnumbered lists:

- List level 1
- List level 2

Structure of numbered lists:

- 1) List level 1
- 2) List level 1
  1. List level 2
  2. List level 2

## 1.5 Applicable documentation

For the safe and correct use of the product, observe the additional documentation that is delivered with the system as well as the relevant standards and laws.

## 1.6 Keeping

Keep the user manual, including the supplied documentation, readily accessible near the system.



## 2. Scope of Delivery/Order Codes

### 2.1 Scope of Delivery

- PQI-DA *smart*
- User Manual
- Ethernet cable
- Calibration certificate
- CD WinPQ lite Software

### 2.2 Order Codes

Characteristic	Code
Power Quality Interface for Low and Medium Voltage Networks <ul style="list-style-type: none"> <li>● 4 voltage converters, 4 current transformers</li> <li>● In accordance with DIN EN-50160 and IEC 61000-4-30 (Class A)</li> <li>● 2 digital inputs</li> <li>● 2 relay outputs</li> <li>● WinPQ lite Software for PQI-DA <i>smart</i></li> </ul>	PQI-DA <i>smart</i>
Supply voltage <ul style="list-style-type: none"> <li>● AC 90 V...264 V or DC 100 V...350 V</li> <li>● DC 18 V - 70 V</li> </ul>	H1 H2
Current inputs <ul style="list-style-type: none"> <li>● 4 current inputs for metering circuit 1A/5A (range 10A)</li> <li>● 4 current inputs for protection circuit 1A/5A (range 100A)</li> <li>● 4 current inputs for Rogowski Coils – Q4/2019</li> <li>● 4 AC current inputs for current clamps (0,5 VAC) – Q4/2019</li> <li>● 4 DC current inputs for current clamps (5,6 VDC) – Q4/2019</li> </ul>	C30 C31 C40 C44 C45
Option communication protocol <ul style="list-style-type: none"> <li>● Modbus RTU &amp; TCP</li> <li>● IEC 61870-5-104 (TCP)</li> <li>● IEC61850 (TCP)</li> </ul>	P0 P1 P2
Option IEC61000-4-7 (40,96kHz sampling) <ul style="list-style-type: none"> <li>● 10.24kHz sampling; without 2kHz to 9kHz measurement</li> <li>● Frequency measurement of voltage and current from 2 kHz to 9 kHz</li> <li>40.96kHz sampling oscilloscope recorder</li> </ul>	B0 B1



With a license code it is possible to upgrade the option 2kHz to 9kHz (40,96kHz sampling rate for oscilloscope trigger) as well as the SCADA communication protocols (P - features).

We take care of it.

Software WinPQ lite	Code
<b>Software WinPQ lite</b> For parameterising <i>PQI-DE</i> , as well as reading <i>PQI-DE</i> measurement data and online data as a single-user licence – <b>free of charge</b>	900.9086
<b>Expansion WinPQ lite</b> For calibration of the <i>PQI-DE</i> and test report creation	900.9287

WinPQ database	Code
<b>Software WinPQ</b> For parameterization, archiving and evaluation of <i>PQI-D</i> , <i>PQI-DA</i> , <i>PQI-DA smart</i> and <i>PQI-DE</i> measurement data with the following basic functions: <ul style="list-style-type: none"> <li>● 32-bit/64-bit Windows program interface</li> <li>● Database for saving the measured values per measuring point Data access via TCP/IP network</li> <li>● Visualization option for all measured variables retrievable from a <i>PQI-D</i>, <i>PQI-DA</i>, <i>PQI-DA smart</i> and <i>PQI-DE</i> as a function of time and as a statistical variable</li> <li>● Automatic reporting according to EN50160; IEC61000-2-2 / 2-4; IEEE519;</li> <li>● Automatic export functions (Comtrade , PQDiff, ASCII, PDF) and fault report transmission</li> <li>● One additional workstation license for one Windows user is included in the price</li> </ul>	<b>WinPQ</b>
<b>Licences</b> <ul style="list-style-type: none"> <li>● as single-user license for 2 PQ measuring instruments (<i>PQI-D</i>, <i>PQI-DA</i>, <i>PQI-DA smart</i>, <i>PQI-DE</i>)</li> <li>● as single-user license for 2 to 10 PQ measuring instruments (<i>PQI-D</i>, <i>PQI-DA</i>, <i>PQI-DA smart</i>, <i>PQI-DE</i>)</li> <li>● as single-user license for &gt; 10 PQ measuring instruments (<i>PQI-D</i>, <i>PQI-DA</i>, <i>PQI-DA smart</i>, <i>PQI-DE</i>)</li> <li>● as single-user license for &gt; 100 PQ measuring instruments (<i>PQI-D</i>, <i>PQI-DA</i>, <i>PQI-DA smart</i>, <i>PQI-DE</i>)</li> </ul>	L0 L1 L2 L3
<b>Operating instructions</b> <ul style="list-style-type: none"> <li>● German</li> <li>● English</li> <li>● French</li> </ul>	A1 A2 A3

<i>PQI-DA smart</i> - accessories	Code
<b>SD-memory card (external):</b> 4 GByte industrial standard	900.9099.04
<b>Frame for panel mounting</b> DIN-Rail, wall mounted housing	564.0435 564.0433
<b>Radio time clock interface DFC 77</b>	111.9024.01
<b>GPS-Clock</b> – Navilog Set - RS485. DIN-Rail GPS receiver, GPS converter 5m connection cable, mounting bracket	111.7083
<b>Power supply for Navilog</b> (DIN rail power supply, 88-264VAC/24V, 10W)	111.7079
<b>Rogowski Coil for C40;</b> 1..3000A; 85mV/1000A; 10Hz..20kHz; 15m connection cable; one piece	111.7087
<b>Current clamp for C44 high accurate for secondary measurement circuits</b> 0...5A; 100mV/A; 10Hz..10kHz; 10m connection cable; one piece	111.7095

### 3. Safety instructions

- Follow the operating instructions.
- Keep the operating instructions with the device.
- Ensure that the device is operated only in a perfect condition.
- Never open the device.
- Ensure that only qualified personnel operate the device.
- Connect the device only as specified.
- Ensure that the device is operated only in the original condition.
- Connect the device only with recommended accessories.
- Ensure that the device is not operated outside the design limits.  
(Refer to the technical data)
- Ensure that the original accessories are not operated outside the design limits.
- Do not use the device in environments where explosive gases, dust or fumes occur.

### 3.1 Meaning of the symbols used on the device



**Nature and source of the danger!** Read the safety instructions inside the manual!



Functional earth



USB-interface



TCP-IP interface



CE marking guarantees compliance with the European directives and regulations regarding EMC



AC alternating voltage



DC direct voltage

#### 3.1.1 Site information and assembly instructions of PQI-DA *smart*

The PQI-DA *smart* is suitable for the following sites:

- Mounted in an cabinet
- Panel mounting

For panel mounting you have to use the frame for **panel mounting order code: 564.0435**.

## 4. Intended use

The product is used for the measurement and evaluation of voltage and current signals in the power grid only. If the instrument is used in a manner not specified by the manufacturer, the protection provided by the instrument may be severely impaired.

The instrument is intended for use in the low voltage range in CAT IV (300V) up to a maximum of 690V conductor / conductor. Other voltage levels such as medium or high voltages must be connected to the instrument via voltage transformers.

## 5. Technical Data

### 5.1 PQI-DA *smart* Description

Solving all measurement tasks in electrical grids can be a daunting task. The new Power Quality Interface and Disturbance Recorder PQI-DA *smart*, aimed at low, medium and high voltage grids, represents the A-Eberle response to such needs. This central component can be used either as Power Quality-Interface in accordance with all Power Quality standards or as a device for all physically defined/measured values in typical three-phase systems.

Beside the possibility of standard evaluations, the PQI-DA *smart* also has a high speed fault recorder capability with a 40.96kHz/10.24kHz recording rate and a half cycle r.m.s. registration, which allows for a detailed analysis of grid disturbances.

In particular, PQI-DA *smart* is suitable for monitoring, registering, evaluating and recording special reference quantities or quality agreements between the supplier of energy and the end customer. In addition, the device can provide many measured values in parallel for SCADA applications via standardized interfaces such as Modbus.

Modern voltage quality measuring instruments operate according to the IEC 62586 standard, which describes the complete product characteristic of a Power Quality Analyser. This standard defines not only the purpose of use and the EMC environment, the environmental conditions, but also the exact measurement methods (IEC 61000-4-30) in order to create a comparable basis for the user.

Devices from different manufacturers operating according to this standard, must offer the same measurement results.

According to IEC 62586, the PQI-DA *smart* is a device PQI-A-FI-H and has therefore been fully certified in external laboratories.

The PQI-DA *smart* meets all demands of the IEC 61000-4-30 Ed.3 (2015) standard for an A-Class device.

Parameter IEC61000-4-30	Class
Power frequency	A
Magnitude of the Supply Voltage	A
Flicker	A
Supply voltage dips and swells	A
Voltage interruptions	A
Supply voltage unbalance	A
Voltage harmonics	A
Voltage Interharmonic	A
Mains signalling voltage	A
Underdeviation and overdeviation	A
Measurement aggregation intervals	A
Time-clock uncertainty	A
Flagging	A
Transient influence quantities	A

The PQI-DA *smart* has been developed for measurements performed in public grids, as well as for recording PQ data in industrial environments, up to 690V (L-L) measurement voltage:

- No moving parts (fans, hard drives)
- CAT IV
- Expandable storage capability (can be extended up to 32 GB by the user, permitting several years recording without connection to database)
- ▶ **Optional “IEC61000-4-7 - 2kHz to 9kHz” (B1)**
  - Frequency measurement of voltage and current according IEC 61000-4-7 from 2 kHz to 9 kHz.
  - Standard IEC61000-4-7 describes the measuring of harmonics and interharmonic in power supply grids and connected devices.

## 5.2 Technical Data

- 1.7-inch colour display
- Keypad for basic/direct device configuration
- 1 GB internal memory
- Input channel bandwidth 20 kHz
- 4 voltage inputs Final value of measurement range: 57/ 230/ 480V L-N, accuracy < 0.1%
- 4 current inputs 1A/5A nominal, Final value of measurement range: 10A
- Simultaneous processing of sampled and calculated voltages and currents
- Oscilloscopic voltage and current recorder sampling rate : 40.96kHz / 10.24kHz
- Half cycle recorder:
  - power frequency, r.m.s. of voltages and currents, voltage and current phasors
  - power recording rate : ~10ms(50Hz) / ~8.33ms (60Hz)
- Powerful recorder triggering
- Online streaming of voltages and currents at 40.96 kHz sampling rate.
- IEC 61000-4-30 Class A Measurement data processing
- Recording of the voltage quality faults in accordance with DIN EN 50160; IEC61000-2-2; -2-12;-2-4.
- Spectral analysis 2 kHz...9 kHz,(35 frequency bands, BW = 200Hz) of voltages and currents according (IEC 61000-4-7)
- Phase of voltage and current harmonics n=2..50
- 2 general purpose digital inputs with 2 input level options
- 2 relay outputs for protection monitoring and alarm
- Complex analysis software WinPQ lite (sold as a package)

### ▶ Option WinPQ – Database Software

- Analysis of the data on an MYSQL-based database using the WinPQ software package.
- Permanent communication with many devices, in parallel.

## 5.2.1 Voltage Inputs

Voltage inputs	E00
Channels	U <sub>1</sub> , U <sub>2</sub> , U <sub>3</sub> , U <sub>N/E/4</sub>
Electrical safety DIN EN 61010	300V CAT IV 600V CAT III
Input reference level	PE
Impedance -> PE	10 MΩ    25pF
Nominal input voltage Un	230VAC
Full scale range (FSR)	0...480VAC L-E
Waveform	AC & DC, any
Maximum crest factor @ Un	3
Bandwidth	DC...20kHz
Nominal power frequency fn	50Hz / 60Hz
Frequency range of the fundamental	fn ± 15% 42.5..50..57.5Hz 51.0..60..69.0Hz
<b>Accuracy</b>	
Fundamental, r.m.s	±0.1% Un (0°C...45°C) ±0.2% Un (- 25°C...55°C) @ 10%...150%Un
Fundamental, Phase	±0.01° @ 10%...150%Un
Harmonics n = 2..50, r.m.s.	±5% of reading @ U <sub>h</sub> ≥ 1% Un ±0.05% Un @ U <sub>h</sub> < 1% Un
Harmonics n = 2..50, Phase	±n·0.01° @ U <sub>h</sub> ≥ 1% Un
Interharmonics n = 1..49, r.m.s.	±5% of reading @ U <sub>ih</sub> = ≥ 1% Un ±0.05% Un @ U <sub>ih</sub> < 1% Un
Power frequency	±1mHz @ 10%...200%Un
Flicker DIN EN 61000-4-15:2011	Class F2
Dip residual voltage	±0.2% Un @ 10%..100%Un
Dip duration	±20ms @ 10%..100%Un
Swell residual voltage	±0.2% Un

Voltage inputs	E00
	@ 100%..150%Un
Swell duration	±20ms @ 100%..150%Un
Interruption duration	±20ms @ 1%..100%Un
Voltage unbalance	±0.15% @ 1%..5% reading
Mains signalling voltage (< 3kHz)	±5% of reading @ U <sub>s</sub> = 3%..15% Un ±0.15% Un @ U <sub>s</sub> = 1%..3% Un



## 5.2.2 Current inputs

Current inputs		
Option	C30	C31
Channels	I1, I2, I3, IN/4	
Electrical safety DIN EN 61010	300V CAT III	
Input type	Differential, isolated	
Impedance	≤ 4mΩ	
Nominal input current I <sub>n</sub>	5 A <sub>AC</sub>	
Full scale range (FSR)	10A <sub>AC</sub>	100A <sub>AC</sub>
Overload capacity permanent ≤ 10s ≤ 1s	20 A 100 A 500 A	
Waveform	AC, any	
Maximum crest factor @ I <sub>n</sub>	4	
Bandwidth	25Hz...20kHz	

### Accuracy

Fundamental, r.m.s	< 0,1% FSR 5%...100%	< 0,2% FSR 5% ... 10%
Fundamental, Phase	±0,1° 5%...100%	±0,2° 5% ... 10%
Harmonics n = 2..50, r.m.s.	5% 5%...100%	10% 5% ... 10%
Harmonics n = 2..50, Phase	±n·0,1° 5%...100%	±n·0,2° 5% ... 10%
Interharmonics n = 1..49, r.m.s.	±5% 5%...100%	±10% 5% ... 10%

### Current inputs (Rogowski coil 1V) –C40

Option	C40
Channels	I1, I2, I3, IN/4
Impedance	1MΩ
Input range	0.35V <sub>AC</sub>
Bandwidth	DC...20kHz
AC Requirements	galvanic isolated

### Current inputs (current clamps)

Feature	C44	C45
Channels	I1, I2, I3, IN/4	
Impedance	1MΩ	1MΩ
Input range	0,5 V <sub>AC</sub>	5,6 V <sub>DC</sub>
Bandwidth	DC...20kHz	
AC Requirements	galvanic isolated	

### 5.2.3 Binary inputs – binary outputs

Binary inputs (BI)	
Range	48 - 250 V AC/DC
<ul style="list-style-type: none"> <li>● H – Level</li> <li>● L – Level</li> </ul>	<p>&gt; 35 V</p> <p>&lt; 20 V</p>
Signal frequency	DC ... 70 Hz
Input resistance	> 100kΩ
Electrical isolation	Optokoppler, electrically isolated
Electrical safety IEC 61010-1:2010 + Cor.:2011, DIN EN 61010-1:2011	300V CAT II



#### Connection cable to be used

- Provide fuses for protection for CAT II
- No mix of touchable and dangerous active circuits.
- Connecting cables must be designed for a temperature of at least 62 ° C.

Binary outputs (BO)	
Contact specification (EN60947-4-1, -5-1) :	
Configuration	SPDT
Rated voltage	250VAC
Rated current	6A
Rated load AC1	1500VA
Rated load AC15, 230VAC	300VA
Breaking capacity DC1, 30/110/220 V	6/0.2/0.12A
No. of switching operations AC1	≥ 60·10 <sup>3</sup> electrical
Electrical isolation	Isolated from all internally potentials
Electrical safety IEC 61010-1:2010 + Cor.:2011, IEC 61010-1:2011	300V CAT II

## 5.2.4 Power supply for PQI-DA *smart*

Power supply		
Feature	H1	H2
AC	100 - 240 V (+/-10%)	-
DC	100V-350V	18 - 70 V
Power consumption.	< 20VA	≤ 10 Watt
Frequency	50 - 60Hz (-6%/+5%)	-
External fuse characteristics	6A B	6A B
Electrical safety IEC 61010-1:2010 + Cor.:2011, DIN EN 61010-1:2011	CAT II	CAT II

### Functional ground



The function earth is the reference potential for the voltage inputs.

  
**DANGER!**

#### Risk of death due to electric shock!

- ➔ The functional earth must always be connected to PE potential.
- ➔ The functional earth must under no circumstances carry a dangerous voltage.

### 5.2.5 Storage of measured values

Storage of measured values	
Internal memory	1024 MB
SD memory card	1 GByte to 32 GByte

### 5.2.6 Communication protocols

Communication Protocols
<ul style="list-style-type: none"><li>● MODBUS RTU</li><li>● MODBUS TCP</li></ul>
<ul style="list-style-type: none"><li>● IEC60870-5-104 (Option P1)</li><li>● IEC61850 (Option P2)</li></ul>

### 5.2.7 Time synchronization interface

Time synchronization protocols (Receive / Slave)
<ul style="list-style-type: none"><li>● IEEE1344 / IRIG-B000...007</li></ul>
<ul style="list-style-type: none"><li>● GPS (NMEA +PPS)</li></ul>
<ul style="list-style-type: none"><li>● DCF77</li></ul>
<ul style="list-style-type: none"><li>● NTP</li></ul>

### 5.2.8 Other interfaces

Interfaces	
Ethernet	RJ45 (10/100 Mbit)
USB	USB – Type-C
2 * RS232/RS485	On terminals Switchable

<b>NOTICE!</b>	<b>Property damage due to unauthorized IT access via network interface!</b>
	<ul style="list-style-type: none"><li>➤ IT security guidelines for the place and purpose of use must be observed!</li><li>➤ IT security settings of the device must be observed!</li></ul>



#### LAN, COM interface

- Even when disconnected, all COM and LAN connecting cables must not fall below the insulation distance to dangerous parts.
- It must not be possible to disconnect individual wires from the clamp.
- Pull the plugs only directly on the housing, never on the cable.
- Make sure that the connection cable is fixed or strain-relieved.

## 5.2.9 Electrical safety – environmental parameter

Environmental parameters	Storage and transport	Operation
Ambient temperature : Limit range of operation	IEC 60721-3-1 / 1K5 -40 ... +70°C IEC 60721-3-2 / 2K4 -40 ... +70°C	IEC 60721-3-3 / 3K6 -25 ... +55°C
Ambient temperature : Rated range of operation H1 Rated range of operation H2	---	IEC DIN EN 61010 -25 ... +45°C -25 ... +50°C
Relative humidity: 24h average No condensation or ice	5...95 %	5...95 %
Solar radiations	---	700W/m <sup>2</sup>
Vibration, earth tremors	IEC 60721-3-1 / 1M1 IEC 60721-3-2 / 2M1	IEC 60721-3-3 / 3M1

### Electrical safety

- IEC 61010-1
- IEC 61010-2-030

Protection class	1
Pollution degree	2
Overvoltage category mains supply option : H1 H2	300V / CAT III 150V / CAT III
Measurement category	300V / CAT IV 600V / CAT III
Altitude	≤ 2000m

### Electromagnetic Compatibility

#### Immunity

- IEC 61000-6-5, Environment H

#### Emissions

- CISPR22 (EN 55022) , Class A

We take care of it.

### 5.3 Mechanical design

The PQI-DA *smart* can be wall-mounted (optional DIN-rail), in-panel mounted (optional mounting frame) or used as a DIN-rail housing. On the front are one SD-Cord-Slot and one USB-connection available. The connection to the COM interfaces is via connectors with plug-in spring clamps. All other connections are screw terminals.

For the TCP/IP interface one RJ 45-connector is available.

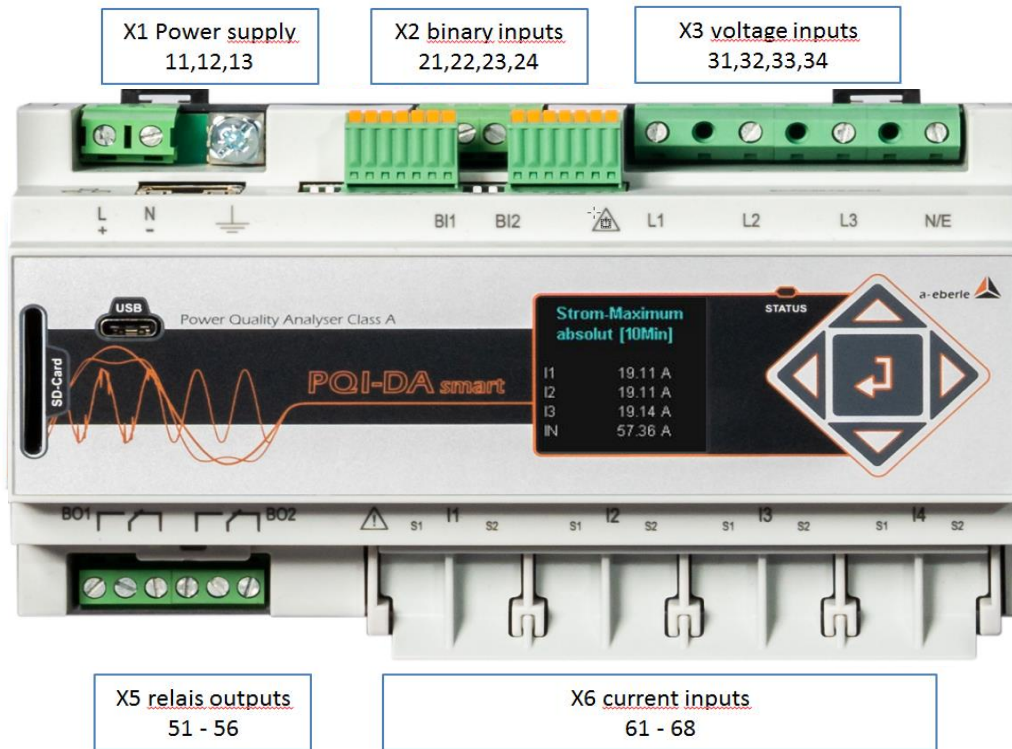

Front view PQI-DA smart

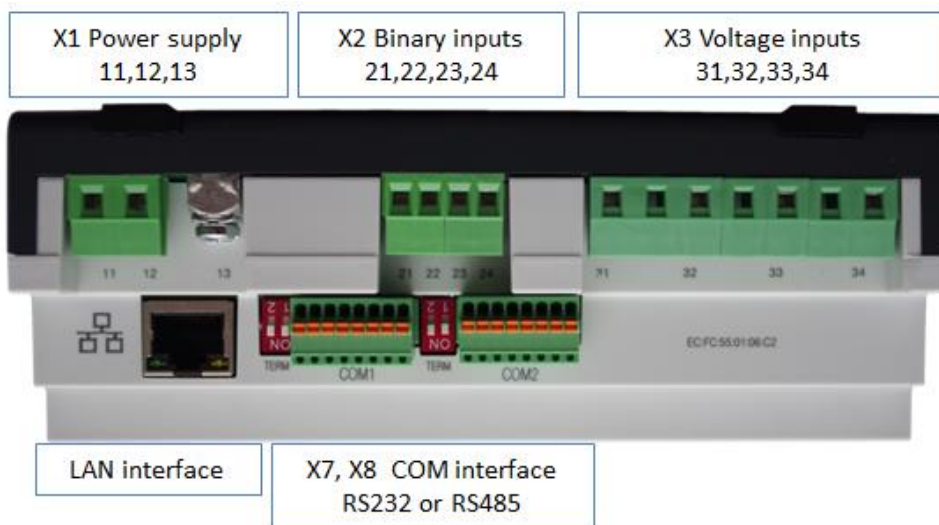

Side view of PQI-DA smart

### 5.3.1 Battery



*Side view of PQI-DA smart*

▶ **Changing the battery:**

The battery life time is > 5 years

A battery change does not affect the device operation when the power supply is connected and the device is internally supplied with power.

Pull the battery out of the housing and insert a new battery

▶ **Battery type:**

Li- button cell CR1632

## 5.4 Terminal strip number PQI-DA *smart*

Terminal strip no.	Designation		Function	Terminal no.	Cable cross section mm <sup>2</sup>	Stripped length in mm
X1	Auxiliary voltage	U <sub>H</sub>	L (+)	11	0,75 – 1,5	6
			L (-)	12	0,75 – 1,5	6
X1	Ground	GND	E	13	1,5 – 2,5	8
X2	Binary inputs 230V High > 35V Low < 20 V	BI1	+	21	0,75 – 1,5	6
			-	22	0,75 – 1,5	6
		BI2	+	23	0,75 – 1,5	6
			-	24	0,75 – 1,5	6
X3	Phase voltage	U1	L1	31	0,75 – 1,5	6
	Phase voltage	U2	L2	32	0,75 – 1,5	6
	Phase voltage	U3	L3	33	0,75 – 1,5	6
	Neutral point voltage	U4	N	34	0,75 – 1,5	6
X5	Binary output 1	R1	NC contact	51	0,75 – 1,5	6
			Pol	52	0,75 – 1,5	6
			NO contact	53	0,75 – 1,5	6
	Binary output 2	R2	NC contact	54	0,75 – 1,5	6
			Pol	55	0,75 – 1,5	6
			NO contact	56	0,75 – 1,5	6
X6	Phase current L1	I1	S1 S2	61 62	1,5 - 4	8
	Phase current L2	I2	S1 S2	63 64	1,5 - 4	8
	Phase current L3	I3	S1 S2	65 66	1,5 - 4	8
	Neutral conductor / sum current	I4	S1 S2	67 68	1,5 - 4	8



## 5.5 Supply voltage connection

The PQI-DA *smart* is available in two different supply voltage characteristics.

Feature	H1	H2
AC	90 - 264 V	-
DC Range of application	100V-350V	18 - 70 V

- ➔ Depending on the power supply unit installed, supply the meter with the correct voltage range.
- ➔ Before connecting, check the feature on the nameplate and compare with voltage supply.

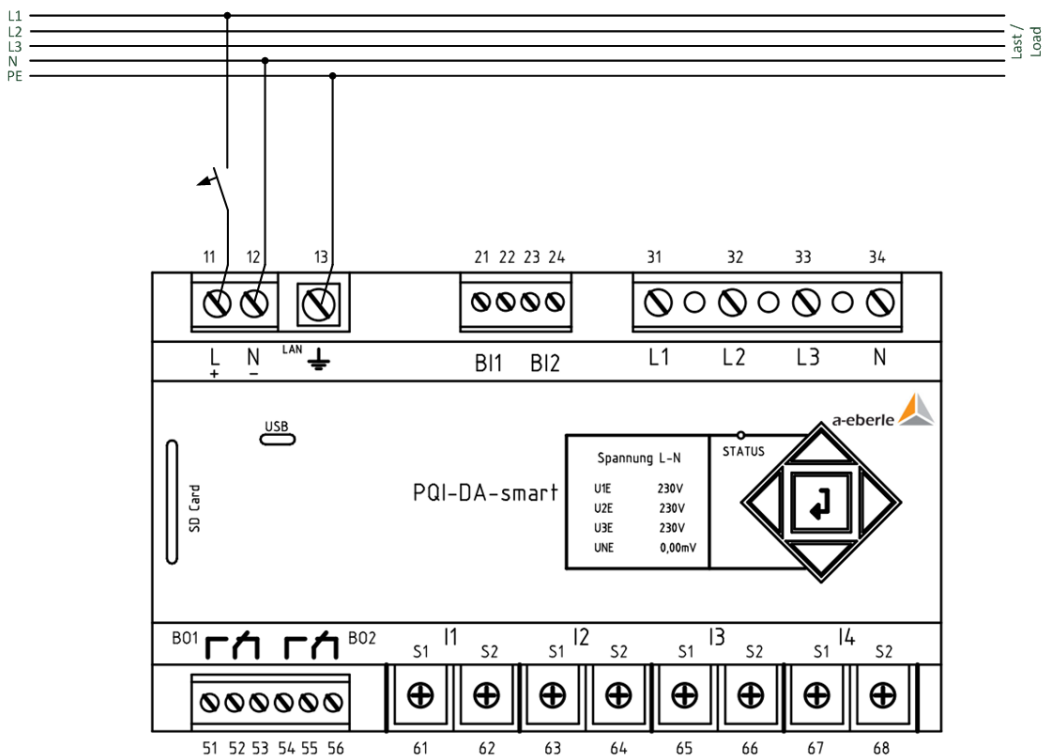



Example of connection to 230V AC with feature H1

  
**DANGER!**

**Risk of death due to electric shock**

➔ Make sure that the device is connected in the voltage-free condition.

 <b>WARNING!</b>	<b>Overheating</b> <ul style="list-style-type: none"><li>➤ The temperature resistance of the connecting cables must be taken into account.</li><li>➤ Danger from overheating and fire</li></ul>
--	---

 <b>WARNING!</b>	<b>Risk of electric shock!</b> <ul style="list-style-type: none"><li>➤ Make sure that all connecting cables are fixed and strain-relieved.</li><li>➤ All cable requirements of the terminal blocks must be observed. (e.g. stripping length of cables)</li></ul>
--	--

<b>NOTICE!</b>	<b>Device damage if features H1 / H2 were reversed</b> <ul style="list-style-type: none"><li>➤ Before connecting the supply voltage, check the permissible supply voltages against the nameplate on the PQI-DA <i>smart</i>!</li></ul>
----------------	--



### Fusing of the auxiliary power supply

The PQI-DA-*smart* has to be fitted with a line circuit breaker in the building installation which meets the requirements of IEC 60947-1 and IEC 60947-3 and is suitable for use as a disconnecting device for the auxiliary power supply of the PQI-DA-*smart*.

Circuit breaker characteristic B is recommended. The rated current of the line circuit breaker depends on the number of connected devices but should not be less than 6A and not more than 10A. Three devices can be supplied via a B6 circuit breaker and a maximum of 6 PQI-DA-*smarts* can be supplied via B10. The circuit breaker must be arranged nearby the device, clearly marked as a separation switch for the device and for the users easily accessible.

**H1:** supplied by a CATII AC-voltage protected with an external circuit breaker not less than 6A and not more than 10A.

**H2:** supplied by a CATII DC-voltage protected by an external circuit breaker not less than 6A and not more than 10A.

## 5.6 Mains connection for PQI-DA smart

The mains connection of the PQI-DA *smarts* depends on the type of mains in which the measurement is to be made.

The PQI-DA *smart* is designed for direct measurement in low voltage (usually 3-phase / 4-wire connection) with or without N-wire current (chapters 5.6.1 and 5.6.2). A special form of low voltage measurement is measurement in the 4-wire 1 phase connection (Chapter 5.6.3) with which three independent voltage circuits and current circuits can be measured at the same earthing conditions.

For medium and high voltage, the device can be connected via suitable converters. A connection with three voltage and current transformers is possible (chapter 5.6.4) as well as the connection via transformer economy circuits (V-circuit, Aron circuit) - chapter 5.6.4.1

A DC measurement is also possible via the corresponding converter (chapter 5.6.6).

### 5.6.1 3-phase / 4-wire connection

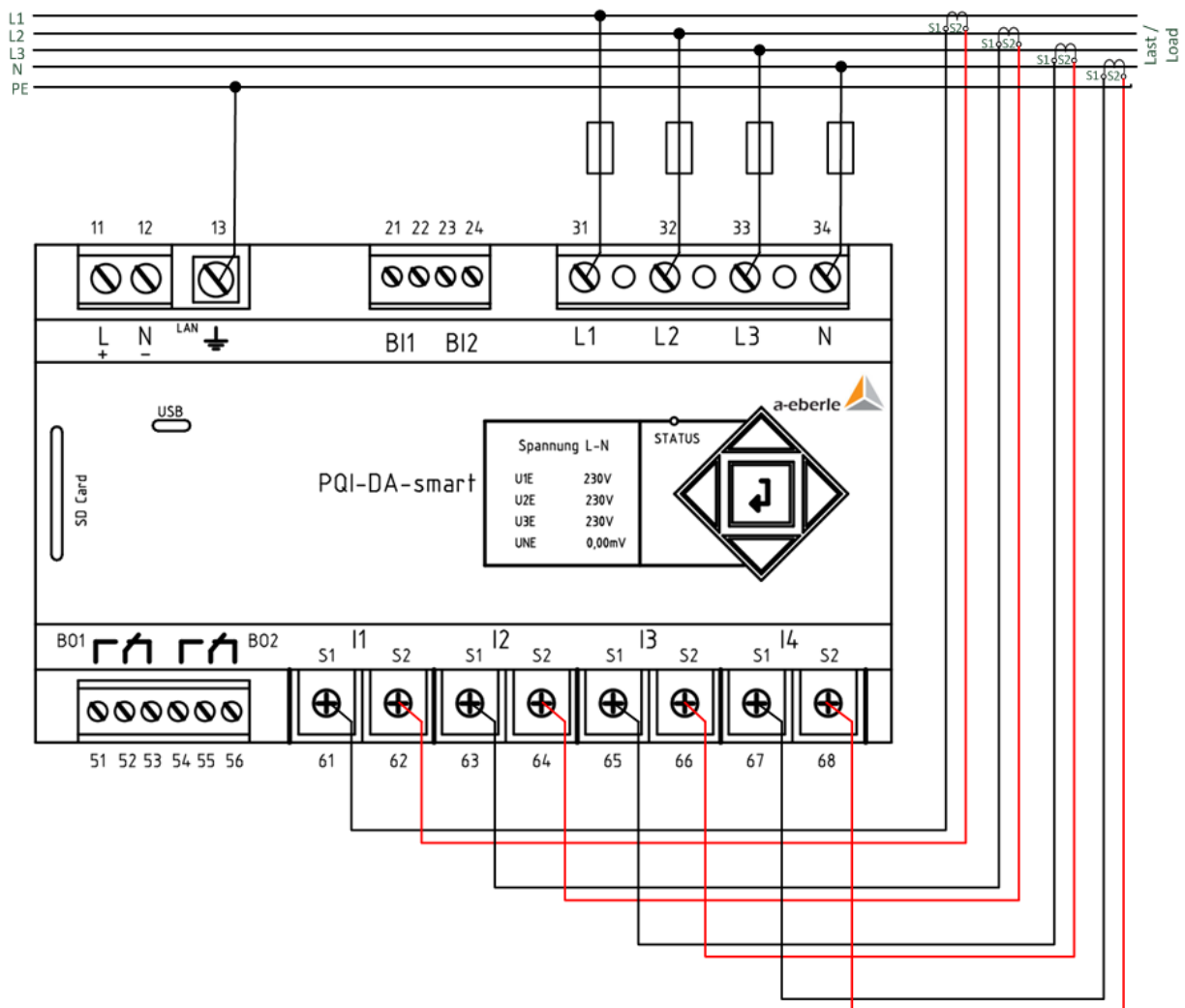

Example of a connection for a PQI-DA smart in a three-phase four-wire system

▶ **Voltage connections**

- Please ensure that the PE conductor (Earth) is connected to the PQI-DA *smart*.
- If no N conductor is available, connect E and N together.
- Ensure that switching (4-wire) is selected. (Setting via display or software)

▶ **Current connections**

Depending on the characteristics, the PQI-DA *smart* is designed for measuring circuits (C30) or protective circuits (C31). The current transformer ratio is factory-set to nominal current (e.g. 5A) depending on the feature and may have to be adapted to the transformers used. (Chapter 6.5.3)

Only alternating currents, not direct currents can be measured.

 <b>DANGER!</b>	<b>Risk of death due to electric shock!</b>
	Attention dangerous touch voltage!
	Flashover and high short-circuit currents possible in CAT III and CAT IV!
	➤ Before starting work, check that no voltage is applied!
	➤ Protective devices for CAT II, CAT III or CAT IV must be provided.

	➤ High load fuses >10kA or >50kA have to be used according to the CAT
	➤ Short-circuit the current transformer before starting work.

 <b>WARNING!</b>	<b>Risk of electric shock!</b>
	➤ Make sure that all connecting cables are fixed and strain-relieved.
	➤ All cable requirements of the terminal blocks must be observed. (e.g. stripping length of cables)

## 5.6.2 4-wire connection without neutral current

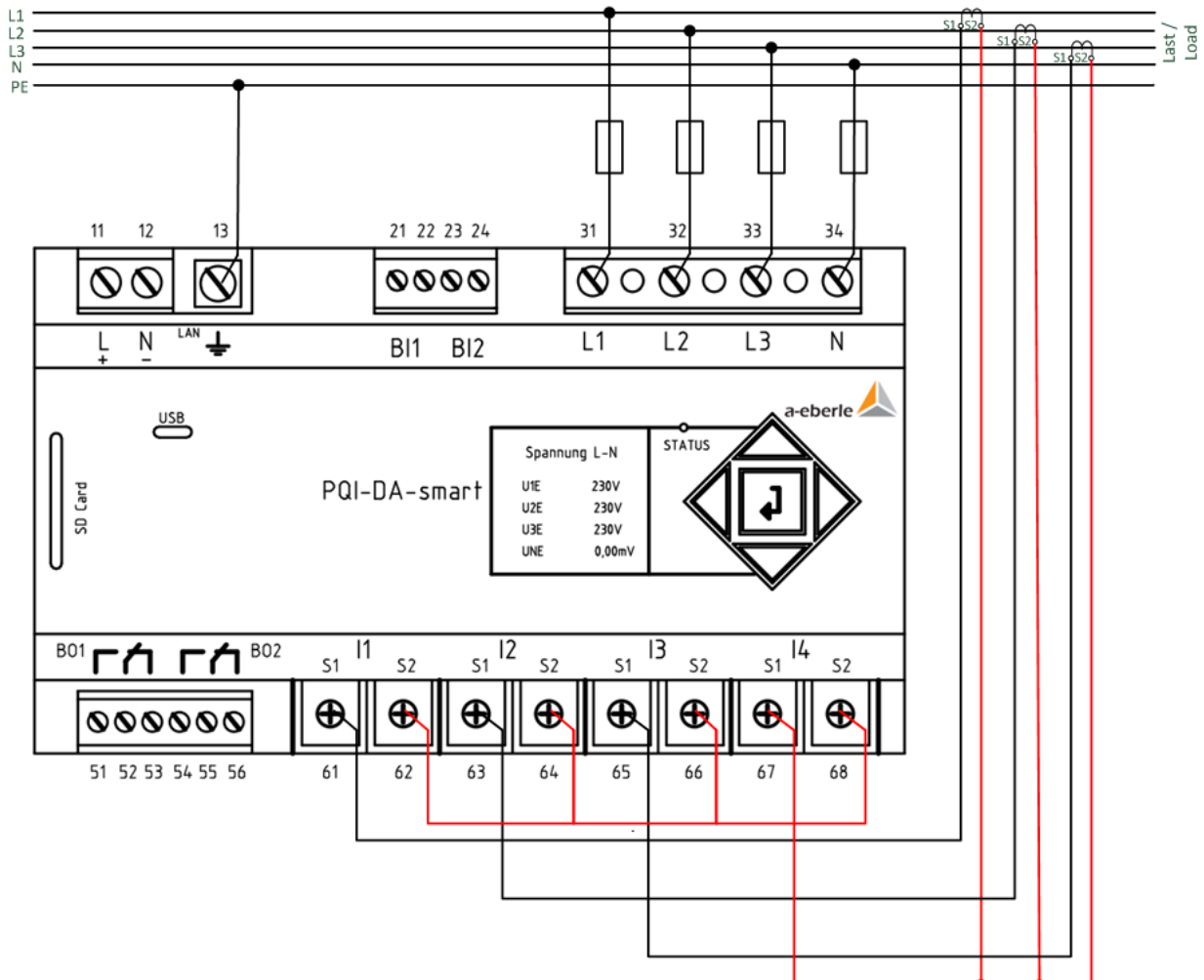

### *PQI-DA smart without neutral conductor Current transformer in 4 conductor connection*

#### ▶ Voltage connections

- ➡ Please ensure that the PE conductor (Earth) is connected to the PQI-DA smart.
- ➡ If no N conductor is available, connect E and N together.
- ➡ Ensure that switching (4-wire) is selected. (Setting via display or software)

#### ▶ Current connections

- ➡ If no neutral phase current is available in the 3-phase 4-wire grid, the S2 current inputs of the PQI-DA smart must all be short-circuited and the S2 terminals of the installed current transformers connected to S1 (terminal X6:67).
- ➡ Depending on the characteristics, the PQI-DA smart is designed for measuring circuits (C30) or protective circuits (C31). The current transformer ratio is factory-set to nominal current (e.g. 5A)

depending on the feature and may have to be adapted to the transformers used. (Chapter 6.5.1). Only alternating currents, not direct currents can be measured.

 <b>DANGER!</b>	<p><b>Risk of death due to electric shock!</b></p> <p>Attention dangerous touch voltage!</p> <p>Flashover and high short-circuit currents possible in CAT III and CAT IV!</p> <ul style="list-style-type: none"><li>➔ Before starting work, check that no voltage is applied!</li><li>➔ Protective devices for CAT II, CAT III or CAT IV must be provided.</li><li>➔ High load fuses &gt;10kA or &gt;50kA have to be used according to the CAT.</li><li>➔ Short-circuit the current transformer before starting work.</li></ul>
---	---

 <b>WARNING!</b>	<p><b>Risk of electric shock!</b></p> <ul style="list-style-type: none"><li>➔ Make sure that all connecting cables are fixed and strain-relieved.</li><li>➔ All cable requirements of the terminal blocks must be observed. (e.g. stripping length of cables)</li></ul>
--	---

### 5.6.3 4-wire 1-phase

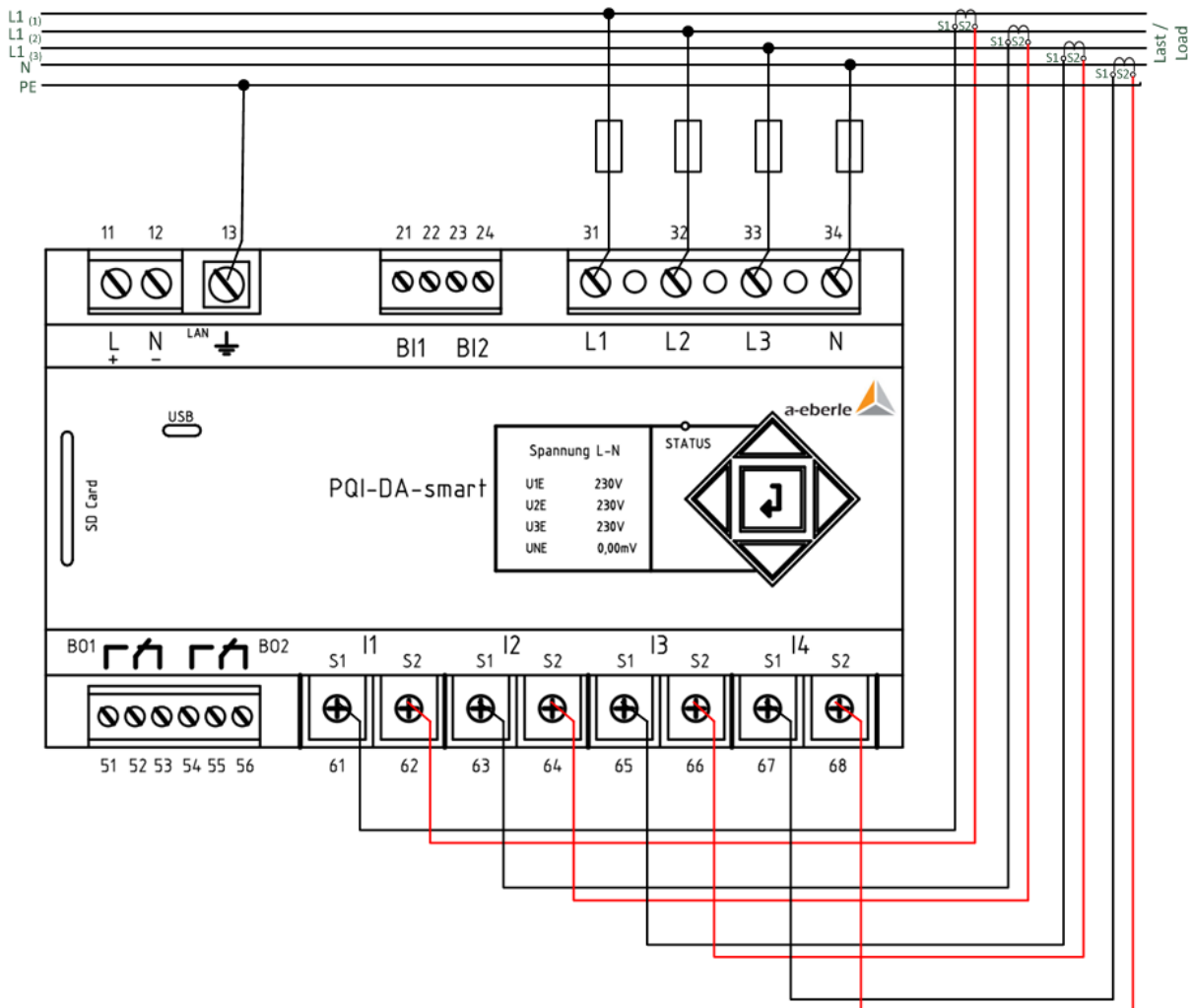

#### *Pqi-DA smart in 4-wire connection -1-phase*

With the 4-wire grid, 1-phase set-up no conductor-conductor events and 3~grid events are evaluated. Any voltage with the same earth potential can be connected (e.g. three grids with the L1 phase) and any current can be connected.

  
**DANGER!**

**Risk of death due to electric shock!**

Attention dangerous touch voltage!

Flashover and high short-circuit currents possible in CAT III and CAT IV!

- ➔ Before starting work, check that no voltage is applied!
- ➔ Protective devices for CAT II, CAT III or CAT IV must be provided.
- ➔ High load fuses >10kA or >50kA have to be used according to the CAT.
- ➔ Short-circuit the current transformer before starting work.



**WARNING!**

**Risk of electric shock!**

Make sure that all connecting cables are fixed and strain-relieved.

All cable requirements of the terminal blocks must be observed. (e.g. stripping length of cables)



## 5.6.4 3-phase / 3-wire connection

### ► Connection to secondary transformer

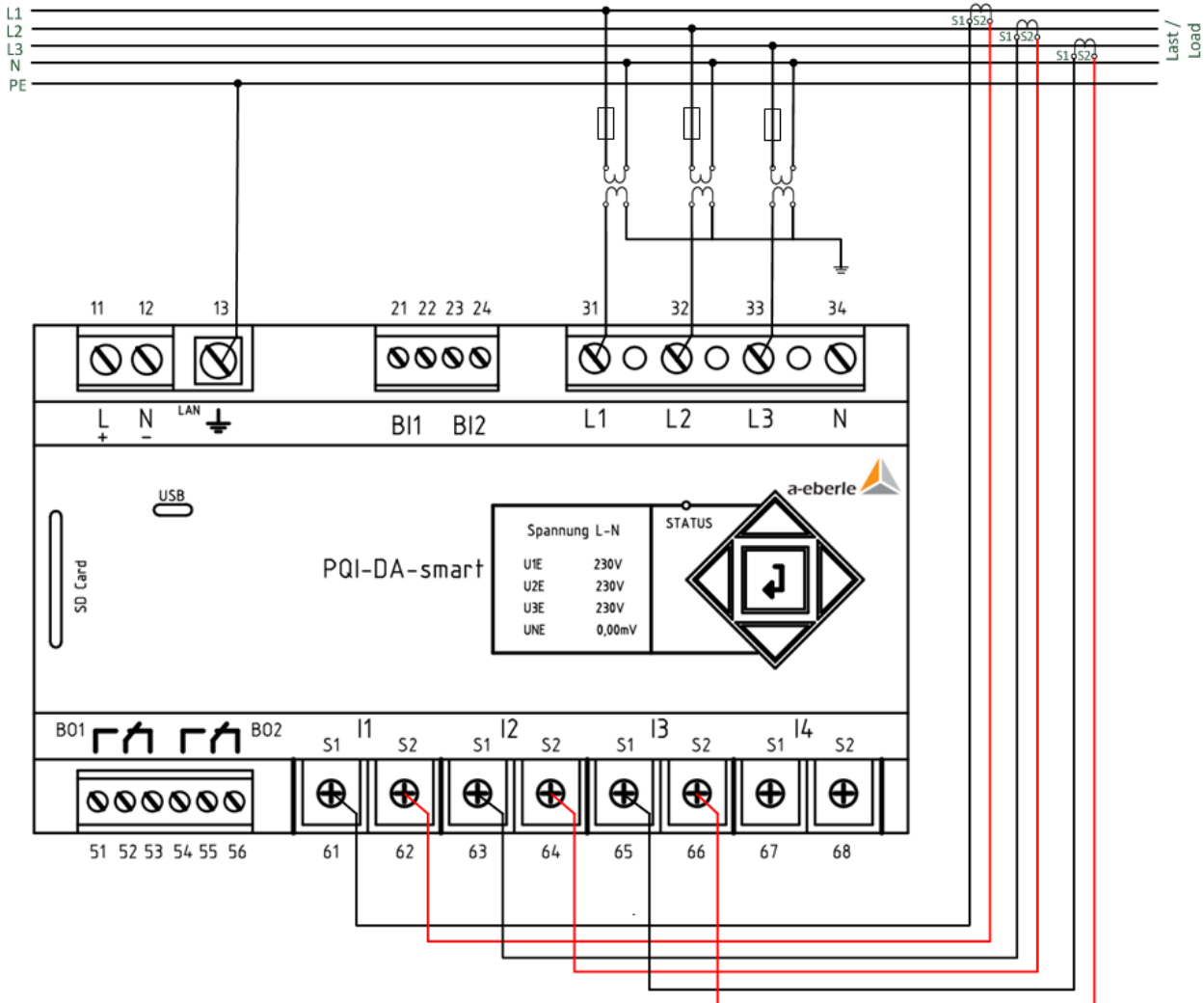

### *PQI-DA smart in three-wire connection for medium and high-voltage networks via converter*

#### ► Connections

- Please ensure that the PE conductor (earth) is connected to the PQI-DA smart.
- Ensure that measurement cable E is connected for each measurement. This is normally the earthing point of the voltage transformer.
- Ensure that switching (3-wire) is selected. (Setting via display or software)
- Set the voltage transformer ratio
- Enter the nominal conductor-conductor voltage
- Set the current transformer ratio



### Connecting PQI-DA *smart* current in a 3-wire grid

If a current is connected to the IN input in the 3-wire network, this is not recorded. The current IN is always calculated while in three-wire operation



#### **Risk of death due to electric shock!**

Attention dangerous touch voltage!

Flashover and high short-circuit currents possible in CAT III and CAT IV!

- ➔ Before starting work, check that no voltage is applied!
- ➔ Protective devices for CAT II, CAT III or CAT IV must be provided.
- ➔ High load fuses >10kA or >50kA have to be used according to the CAT
- ➔ Short-circuit the current transformer before starting work.



#### **Risk of electric shock!**

- ➔ Make sure that all connecting cables are fixed and strain-relieved.
- ➔ All cable requirements of the terminal blocks must be observed. (e.g. stripping length of cables)

### 5.6.4.1 V connection; Aron connection

The V connection or Aron connection can be configured in the device set-up of the software. These connection types are only available in the 3-wire configuration.

- 1) V connection (set-up via the evaluation software)
- 2) Aron connection (set-up via the evaluation software)

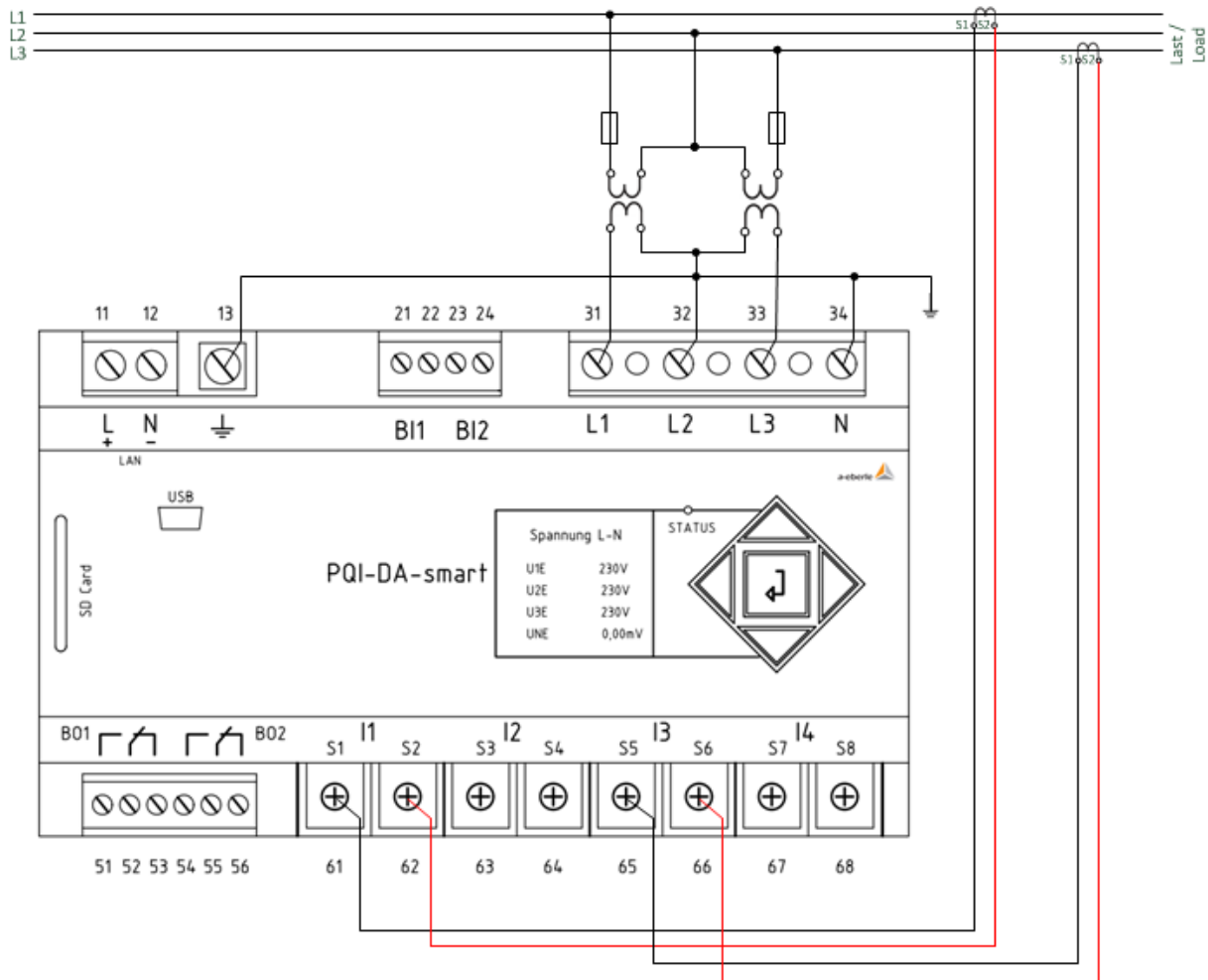

*PQI-DA smart in the V-circuit / Aron circuit for medium and high voltage networks via converters*

#### Possible connection configurations in 3-wire grids:

- Voltage converter connections: 1, 2, 3, 4,
- Current transformer connections: 1, 2, 3, 4,

The voltage converter and current transformer selection fields can be set-up. The grounded voltage in each case or the current that has not been connected is calculated by the measurement device.

- ➔ Make sure that the switching mode (3-wire) is set. (Setting via display or software)
- ➔ Setting the voltage migration ratio.

▶ **3-phase voltage converter connections:**

Connection configuration	VT	Measuring channel				Reference potential
		1	2	3	4	
Voltage converter: L1, L2, L3, N/E	1	u <sub>1</sub>	u <sub>2</sub>	u <sub>3</sub>	u <sub>N/E</sub>	E
V connection, earth L1	2	E	u <sub>2</sub>	u <sub>3</sub>	E	
V connection, earth L2	3	u <sub>1</sub>	E	u <sub>3</sub>	E	
V connection, earth L3	4	u <sub>1</sub>	u <sub>2</sub>	E	E	

▶ **3-phase current transformer connections:**

Connection configuration	CT	Measuring channel			
		5	6	7	8
Current transformer: L1, L2, L3, N	1	i <sub>1</sub>	i <sub>2</sub>	i <sub>3</sub>	i <sub>N</sub>
Current transformer: L2, L3	2	-	i <sub>2</sub>	i <sub>3</sub>	i <sub>4</sub>
Current transformer: L1, L3	3	i <sub>1</sub>	-	i <sub>3</sub>	i <sub>4</sub>
Current transformer: L1, L2	4	i <sub>1</sub>	i <sub>2</sub>	-	i <sub>4</sub>

  
**DANGER!**

**Risk of death due to electric shock!**

Attention dangerous touch voltage!

Flashover and high short-circuit currents possible in CAT III and CAT IV!

- ➔ Before starting work, check that no voltage is applied!
- ➔ Protective devices for CAT II, CAT III or CAT IV must be provided.
- ➔ High load fuses >10kA or >50kA have to be used according to the CAT
- ➔ Short-circuit the current transformer before starting work.

  
**WARNING!**

**Risk of electric shock!**

- ➔ Make sure that all connecting cables are fixed and strain-relieved.
- ➔ All cable requirements of the terminal blocks must be observed. (e.g. stripping length of cables)

## 5.6.5 Low-level signal inputs for current measurement (Features C40 ... C45)

The PQI-DA *smart* is available with the following features for current measurement with external equipment such as Rogowski coils, DC current clamps and AC current clamps.

- 4 inputs for Rogowski coils - feature C40
- 4 AC Low level inputs for mini current clamps (0.5 VAC)- - Feature C44
- 4 DC Low level inputs for mini current clamps (5.6 VDC) - Feature C45

Advantages of measurement via low level inputs are

- Simple installation in switchgear - also retrofitted.
- High frequency resolution for measurement according to VDE - AR 4105 / 4110/4120 in the range 2-9 kHz.
- No separation of the current transformer circuits necessary.

It is imperative to ensure that the technical data of the equipment used is matched to the impedance conditions of the input configuration of the characteristic used!

(The exact technical data are described in chapter: 5.2.2)



### Connection

The parameters 4-wire connection and 3-wire connection are valid for current measurement with C4X features as well as for C3X features.



#### Risk of death due to electric shock!

Attention dangerous touch voltage!

Flashover and high short-circuit currents possible in CAT III and CAT IV!

- ➔ Before starting work, check that no voltage is applied!
- ➔ Protective devices for CAT II, CAT III or CAT IV must be provided.
- ➔ High load fuses >10kA or >50kA have to be used according to the CAT
- ➔ Short-circuit the current transformer before starting work.



#### Risk of electric shock!

- ➔ Make sure that all connecting cables are fixed and strain-relieved.
- ➔ All cable requirements of the terminal blocks must be observed. (e.g. stripping length of cables)

### 5.6.5.1 Connection of low level measurement inputs - feature C40 / C44 / C45

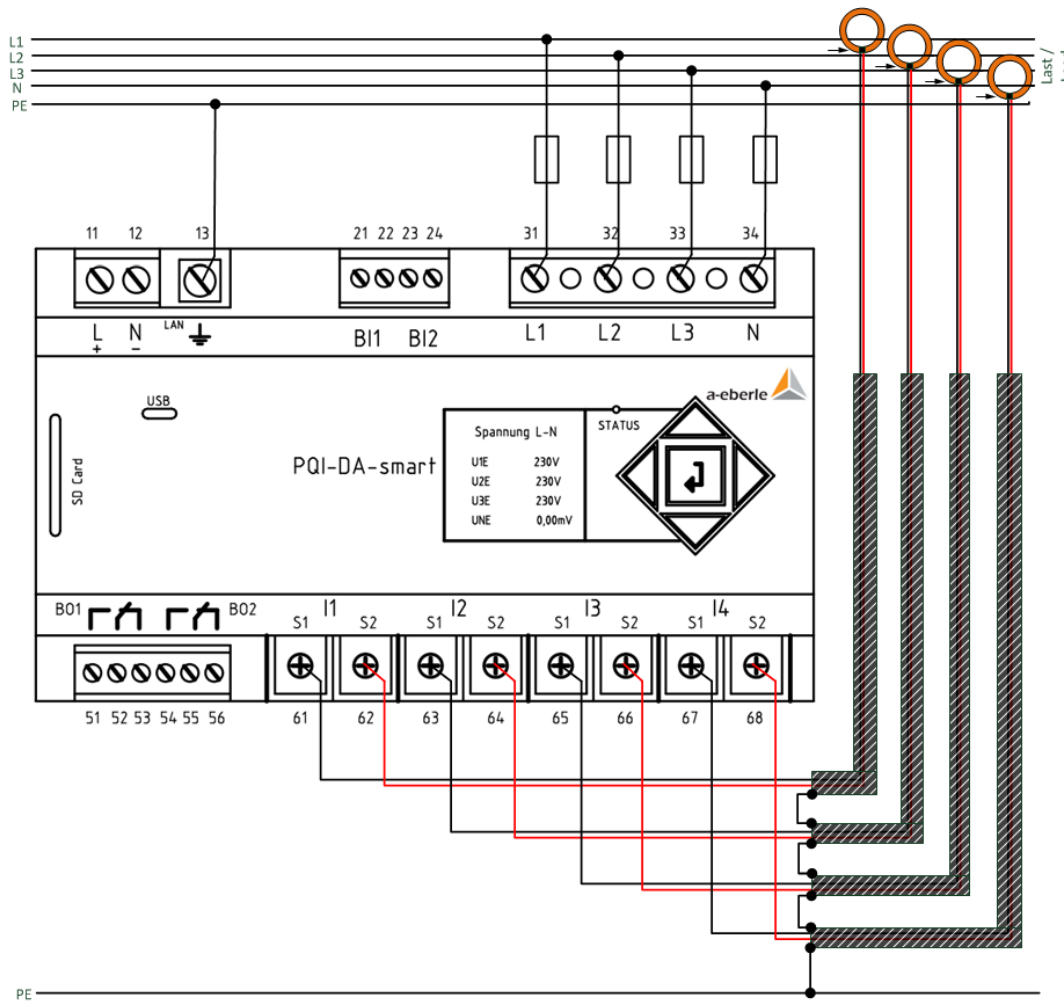

Example of PQI-DA smart connection with Rogowski coils in a 4-wire network



#### Connection PQI-DA smart low level inputs

The shield of the converters used must be earthed in order to minimize stray influences!

Feature C40: The input is calibrated to 85mV/A. When using other converter factors, the converter factor ratio must be set correctly.

**Risk of death due to electric shock!**  
 Attention dangerous touch voltage!  
 Flashover and high short-circuit currents possible in CAT III and CAT IV!

**⚠ DANGER!**

- ➡ Before starting work, check that no voltage is applied!
- ➡ Protective devices for CAT II, CAT III or CAT IV must be provided.
- ➡ High load fuses >10kA or >50kA have to be used according to the CAT
- ➡ Short-circuit the current transformer before starting work.

### 5.6.6 DC mains connection

Using the small signal converters for current measurement described in Chapter 5.6.5, it is generally possible to use the PQI-DA *smart* also in DC systems under the following conditions.

For DC voltage measurement, a difference must be made between symmetrically earthed and solidly earthed systems.

- For IT systems with high-impedance centre grounding, the device is designed for measurements up to  $\pm 600$  V, with more than  $\pm 300$  V an overvoltage protection is required to comply with the CAT III 600 V.
- For TN-S system, the device is designed for measurement up to 600 V.

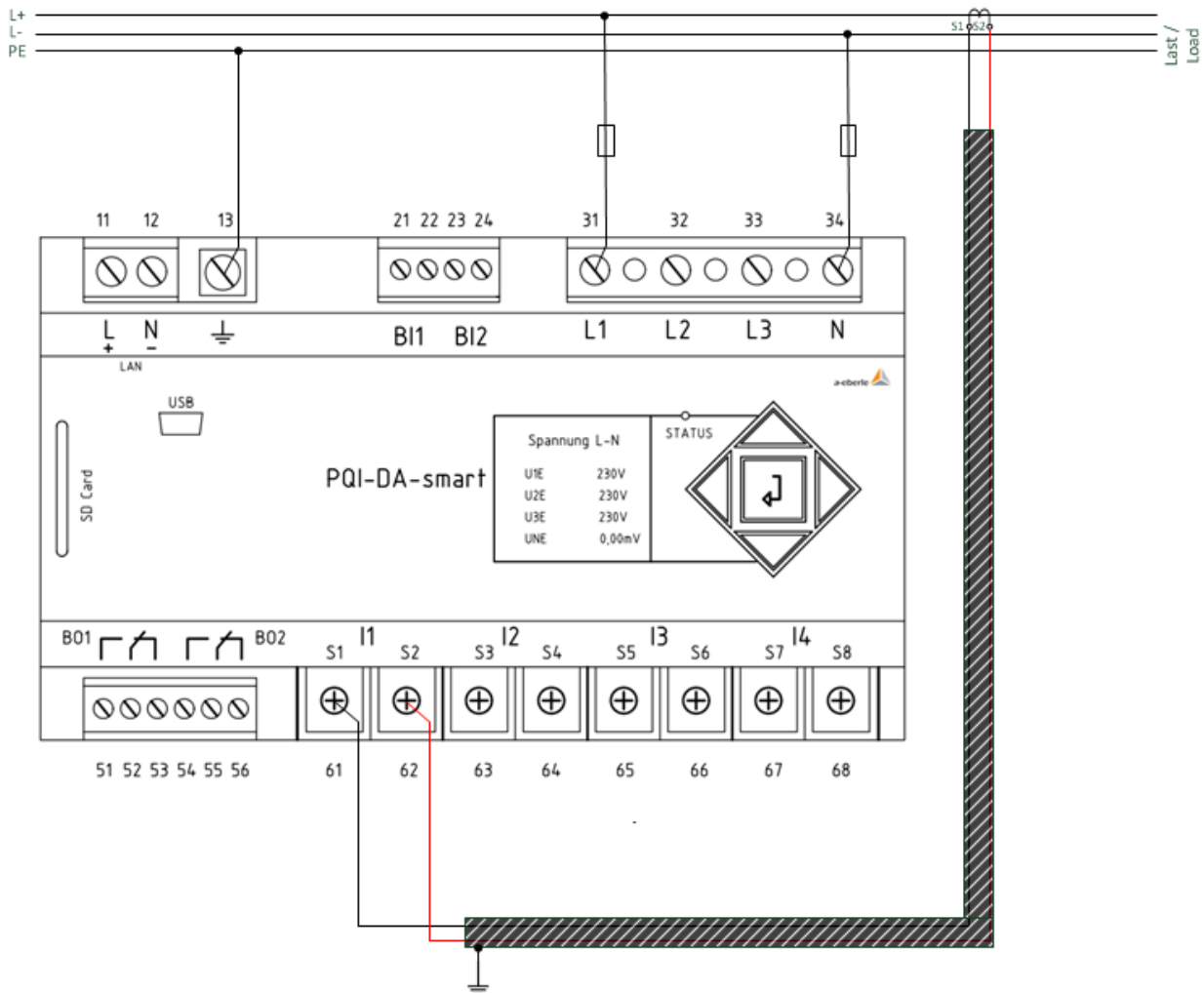

*Example connection PQI-DA smart with current transformer with small signal output (e.g. 4V)*

Depending on the feature, the device is suitable for direct acting current transformers (e.g. open-loop Hall Effect current transformers) with an analogue output voltage up to  $\pm 5.6$  V (typically  $\pm 4$  V or  $\pm 1$  V). The measurable bandwidth on the device is DC...20 kHz. Shielding of the signal lines is recommended, but not absolutely necessary.



**Risk of death due to electric shock!**

Attention dangerous touch voltage!

Flashover and high short-circuit currents possible in CAT III and CAT IV!

- Before starting work, check that no voltage is applied!
- Protective devices for CAT II, CAT III or CAT IV must be provided.
- High load fuses >10kA or >50kA have to be used according to the CAT
- Short-circuit the current transformer before starting work.



**Risk of electric shock!**

- Make sure that all connecting cables are fixed and strain-relieved.
- All cable requirements of the terminal blocks must be observed. (e.g. stripping length of cables)



## 5.7 Additional Interfaces

### 5.7.1 RS232 / RS485 Interfaces

The PQI-DA *smart* has two serial interfaces which can be used either as RS232 or RS485. The changeover and functions are determined by the parameterization via the WinPQ Lite software or the display.

► **The following functions are available:**

- Modbus (RS232 / RS485)
- Time signals from various external timers' further information can be found in chapter 6.5.2

#### 5.7.1.1 Connection and Termination RS232/RS485 Interface

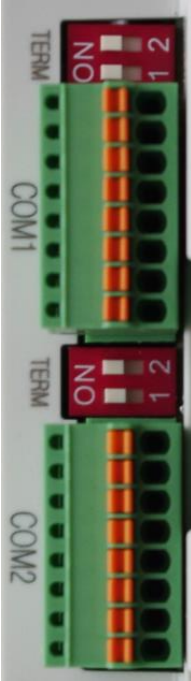
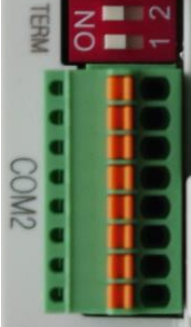
	Interface	Terminal No.	function
	COM 1 (X7)	78	PE / shield (Note note)
		77	RS485 Pos (A)
		76	RS485 Neg (B)
		75	CTS
		74	RxD
		73	GND
		72	RTS
		71	TxD
	COM 2 (X8)	88	PE / shield (Note note)
		87	RS485 Pos (A)
		86	RS485 Neg (B)
		85	CTS
		84	RxD
		83	GND
		82	RTS
		81	TxD

#### Terminals from PQI-DA *smarts* with article numbers 119.75XX



Terminals 78 and 88 are only available in PQI-DA *smarts* with type number group 119.75XX

In PQI-DA *smarts* with article numbers 119.76XX the shield of the serial cable must be connected to PE! Avoid earthing loops (one-sided earthing!)

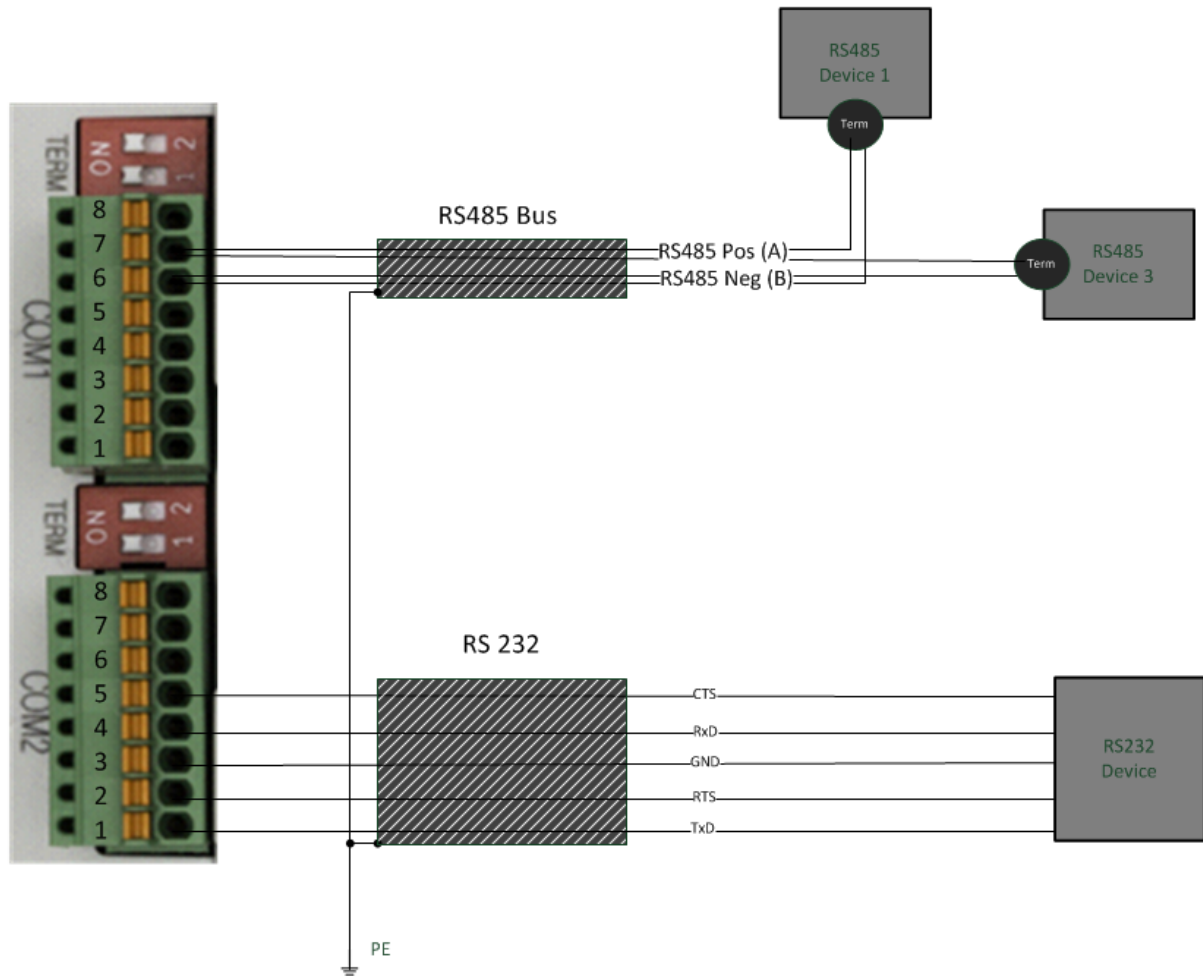

*Wiring example PQI-DA smart COM interfaces!*



Use a twisted shielded cable for the RS232 and RS485 interfaces. The shields of all cables must be connected to a voltage-free ground as close as possible to the device!

Please make sure that the maximum cable length of 1200 m for RS485 and 15 m for RS232 is not exceeded!

► **Termination RS485**

The first and last station on the bus must be terminated. Dip switches "Term 1" for the Com 1 interface and "Term 2" for the Com2 interface is provided on the PQI-DA *smart* for this purpose. Bus termination is switched on with "ON".

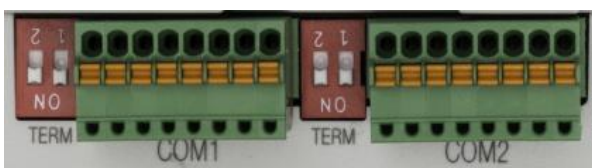

- Set both dips switches to ON:  
Bus termination is switched on
- Both dips switches set to Off:  
Bus termination is switched off

## 5.7.2 Output relays

The PQI-DA *smart* has two binary outputs that can switch both direct current and alternating current.

The following technical functions can be implemented:

- Relay B01 – Watchdog relay  
Self-monitoring of the measurement device
- Relay B02 – Reports new sequence of events recording  
If a new event is captured relay B02 is operated for one second. Settings are described in Chapter 5.7.2



The binary outputs can switch loads directly up to the specified technical specifications!

The connection is made directly via terminals X5! The terminal assignments are specified in chapter 5.4!

 <b>DANGER!</b>	<p><b>Risk of electric shock!</b></p> <ul style="list-style-type: none"> <li>➔ Before starting work, check that there is no voltage!</li> </ul>
--	---

 <b>WARNING!</b>	<p>Risk of electric shock!</p> <ul style="list-style-type: none"> <li>➔ Make sure that all connecting cables are fixed and strain-relieved.</li> <li>➔ All cable requirements of the terminal blocks must be observed. (e.g. stripping length of cables)</li> </ul>
--	---

 <b>CAUTION!</b>	<p><b>Destruction of components due to overload!</b></p> <p>Only loads as specified in the technical specifications may be switched.</p>
--	--

### 5.7.3 Binary Inputs

The PQI-DA *smart* has two binary inputs which can be assigned to the following functions:

- Recorder trigger
- Trigger Interval of power average values (Chapter: 7.5.2.7)
- for recording control

The binary inputs are designed for the voltage 48 - 250 V AC/DC, whereby the level detection is set to the following characteristic values:

- High level > 35 V
- Low level < 20 V

	<b>Risk of electric shock!</b> <ul style="list-style-type: none"><li>➔ Before starting work, check that there is no voltage!</li></ul>
---	--

	<b>Risk of electric shock!</b> <ul style="list-style-type: none"><li>➔ Make sure that all connecting cables are fixed and strain-relieved.</li><li>➔ All cable requirements of the terminal blocks must be observed. (e.g. stripping length of cables)</li></ul>
--	--

	<b>Material damage due to connection</b> <p>Make sure that the supply voltage:</p> <ul style="list-style-type: none"><li>➔ Is inside the technical specification (chapter 5.2.3) is!</li><li>➔ Is correctly polarized!</li><li>➔ Does not exceed the permissible maximum voltage!</li></ul>
---	---

## 5.8 Measurement / Functions

PQI-DA *smart* complies with the automatic event detection and measurement standards, which are:

Standard	Description
EN50160	European power quality standard
IEC61000-2-2	EMC standards in low voltage grids
IEC61000-2-12	EMC standards in medium voltage grids
IEC61000-3-6/7	EMC standards in high voltage grids
IEC61000-2-4 (Class 1, 2, 3)	Industrial EMC standards
IEC61000-3-2/3	Limits for harmonic current emissions
NRS048/IEEE519	International power quality standards
IEC61000-4-30 Class A ed. 3	Methods of measuring power quality
IEC61000-4-7	EMC standards up to 9 kHz
IEC61000-4-15	Flicker measurement

### 5.8.1 Continuous Recording:

Five fixed and two variable measurement time intervals are available for continuous recording. All measured values can be freely activated or deactivated in the data classes.

- 10/12 periods (200ms)
- 1 sec
- n\*sec (can be set from 2 seconds to 60 seconds)
- 150/180 periods (3sec)
- n\*min (can be set from 2 seconds to 60 seconds)
- 10 min
- 2 hrs.

Time Interval Voltage	10/ 12T	150/ 180T	10 min	2 h	1 s	N* s	N* min
Power frequency	✓	✓	✓	✓	✓	✓	✓
Power frequency, 10s-Value (IEC61000-4-30)							
Extremes, standard deviation of power frequency (10s)			✓				
r.m.s. values (IEC61000-4-30)	✓	✓	✓	✓	✓	✓	✓
Extremes, standard deviation of T/2-values			✓				
Under deviation [%], Over deviation [%] (IEC61000-4-30)	✓	✓	✓	✓			
Harmonic subgroups n= 0..50 (IEC61000-4-7)	✓	✓	✓	✓			
Maximum values of 10/12 T harmonic subgroups n = 2..50			✓				
Interharmonic subgroups n=0..49 (IEC61000-4-7)	✓	✓	✓	✓			
Total Harmonic Distortion (THDS) (IEC61000-4-7)	✓	✓	✓	✓	✓	✓	✓
Partial Weighted Harmonic Distortion (PWHHD)	✓	✓	✓	✓	✓	✓	✓
Unbalance, negative-/positive- sequence, sequence sign	✓	✓	✓	✓	✓	✓	✓
Unbalance, zero-/positive- sequence	✓	✓	✓	✓	✓	✓	✓
Positive-, negative-, zero sequence phasors	✓	✓	✓	✓	✓	✓	✓
Phasors (fundamental)	✓	✓	✓	✓	✓	✓	✓
Flicker (IEC61000-4-15)			✓	✓			
Instant flicker (IEC61000-4-15)	✓		✓				
Mains signalling voltages [%] (IEC61000-4-30)	✓	✓					
Phase angle( zero crossings) of phase voltage harmonics n=2..50 to fundamental of reference voltage	✓	✓	✓	✓			

We take care of it.

---

Frequency bands 1..35, 2kHz..9kHz, r.m.s. (IEC61000-4-7)

| | | ✓ | ✓ | ✓ | ✓ | ✓

Time Interval Current	10/ 12T	150/ 180T	10 min	2 h	1 s	N* s	N* min
r.m.s. values	✓	✓	✓	✓	✓	✓	✓
Extremes of T/2-values			✓				
Harmonic subgroups n= 0..50 (IEC61000-4-7)	✓	✓	✓	✓			
Maximum values of 10/12 T harmonic subgroups n = 2..50			✓				
Interharmonic subgroups n=0..49 (IEC61000-4-7)	✓	✓	✓	✓			
Total Harmonic Distortion (THDS) (IEC61000-4-7)	✓	✓	✓	✓	✓	✓	✓
Total Harmonic Currents	✓	✓	✓	✓	✓	✓	✓
Partial Weighted Harmonic Distortion (PWHD)	✓	✓	✓	✓	✓	✓	✓
Partial Odd Harmonic Currents (PHC)	✓	✓	✓	✓	✓	✓	✓
K-Factors	✓	✓	✓	✓	✓	✓	✓
Unbalance, negative-/positive- sequence , sequence sign	✓	✓	✓	✓	✓	✓	✓
Unbalance, zero-/positive- sequence	✓	✓	✓	✓	✓	✓	✓
Positive-, negative-, zero sequence phasors	✓	✓	✓	✓	✓	✓	✓
Phasors (fundamental)	✓	✓	✓	✓	✓	✓	✓
Phase angle( zero crossings) of current harmonics n=2..50 to fundamental of reference voltage	✓	✓	✓	✓			
Frequency bands 1..35 , 2kHz..9kHz, r.m.s. (IEC61000-4-7)			✓	✓	✓	✓	✓

Time Interval Energy	10 min	2 h	1 s	N* s	N* min
Active energy, phase	✓	✓	✓	✓	✓
Active energy, total	✓	✓	✓	✓	✓
Exported active energy, phase	✓	✓	✓	✓	✓
Exported active energy, total	✓	✓	✓	✓	✓
Imported active energy, phase	✓	✓	✓	✓	✓
Imported active energy, total	✓	✓	✓	✓	✓
Reactive energy (inductive), phase	✓	✓	✓	✓	✓
Reactive energy (inductive), total	✓	✓	✓	✓	✓
Exported reactive energy (inductive), phase	✓	✓	✓	✓	✓
Exported reactive energy (inductive), total	✓	✓	✓	✓	✓
Imported reactive energy (inductive), phase	✓	✓	✓	✓	✓
Imported reactive energy (inductive), total	✓	✓	✓	✓	✓

Time Interval Power	10 min	2 h	1 s	N* s	N* min
Active power, phase	✓	✓	✓	✓	✓
Active power, total	✓	✓	✓	✓	✓
Active power extremes	✓				
Reactive power, phase	✓	✓	✓	✓	✓
Reactive power, total	✓	✓	✓	✓	✓
Reactive power extremes	✓				
Apparent power, phase	✓	✓	✓	✓	✓
Apparent power, total	✓	✓	✓	✓	✓
Fundamental active power, phase	✓	✓	✓	✓	✓
Fundamental active power, total	✓	✓	✓	✓	✓
Fundamental reactive power, phase	✓	✓	✓	✓	✓
Fundamental reactive power (displacement), total	✓	✓	✓	✓	✓
Fundamental apparent power, phase	✓	✓	✓	✓	✓
Phase angle of fundamental apparent power, phase	✓	✓	✓	✓	✓

We take care of it.

Fundamental apparent power, total	✓	✓	✓	✓	✓
Phase angle of fundamental apparent power, total	✓	✓	✓	✓	✓
Reactive distortion power, phase	✓	✓	✓	✓	✓
Reactive distortion power, total	✓	✓	✓	✓	✓
Active power factors, phase, total	✓	✓	✓	✓	✓
Reactive power factors, phase, total	✓	✓	✓	✓	✓
COS $\phi$ + sign, phase, total	✓	✓	✓	✓	✓
SIN $\phi$ + sign, phase, total	✓	✓	✓	✓	✓
COS $\phi$ + sign of reactive distortion power, phase, total	✓	✓	✓	✓	✓
Capacitive-, inductive scaling factor of COS $\phi$ (-1..0..+1) :	✓	✓	✓	✓	✓
Triggered interval mean active power, phase					
Triggered interval mean active power, total					
Triggered interval mean reactive power, phase					
Triggered interval mean reactive power, total					

## 5.8.2 PQ Events

trigger quantity	lower	upper
voltage dip (T/2)	✓	
voltage swell (T/2)		✓
voltage interruption (T/2)	✓	
voltage rapid voltage change (T/2)	sliding average filter mean +/- threshold	
voltage change (10min)	✓	✓
voltage unbalance (10min)		✓
mains signalling voltage (150/180T)		✓
voltage harmonics (10min)		✓
voltage THD (10min)		✓
voltage short term flicker PST (10min)		✓
voltage long term flicker PLT (10min)		✓
power frequency (10s)	✓	✓

## 5.8.3 Recorder triggering

trigger quantity	lower	upper	step
r.m.s. phase voltages (T/2)	✓	✓	✓
r.m.s. phase-phase voltages (T/2)	✓	✓	✓
r.m.s. residual/neutral-ground voltage (T/2)		✓	✓
Positive sequence voltage (T/2)	✓	✓	
Negative sequence voltage (T/2)		✓	
Zero sequence voltage (T/2)		✓	
Phase voltage phase (T/2)			✓
phase voltages wave shapes (wave shape filter)	+/- threshold		
phase-phase voltages wave shapes (wave shape filter)			
residual/neutral-ground voltage wave shape (wave shape filter)			
r.m.s. phase currents (T/2)	✓	✓	✓
r.m.s. total / neutral current (T/2)		✓	✓
Power frequency (T/2)	✓	✓	✓
Binary inputs (debounced)	rising, falling slope		
Command	external		



## 5.8.4 Memory management

The PQI-DA smart is equipped with one gigabyte of internal memory and intelligent memory management. This ensures that the oldest data records are always overwritten by the most current data according to the First in First out principle (FIFO).

By default, the measuring device is divided into two memory areas:

- Continuous measurement data with 50% of the total memory
- Fault record and events and other asynchronous measurement data

In the standard parameterization with approx. 800 measured variables in the 10 min data class, the device is able to continuously and seamlessly record all 800 measured variables such as current, voltage, harmonics and power over 140 weeks.



It is possible to change the memory allocation using parameters. Please contact the support of A.Eberle.

### 5.8.4.1 Memory Expansion with SD Card

If a SD-card is inserted in the device, you have to choose between different methods of using the SD-card.

- Copy all data of the last 7 days
- Copy all data of the last 30 days
- Copy all data a complete snapshot of the whole internal memory to SD-card
- Circular (ext.) = the SD-card will stay in the device and will be filled in a circular memory. If the SC-card is bigger than one gigabyte, the time period of the SD-card is much longer than into the PQI-DA *smart*. (extended Memory)

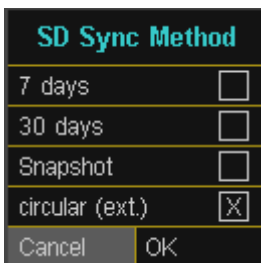

Confirm with “OK” and the PQI-DA *smart* will start automatically to copy the selected internal memory onto the SD card.



The minimum size of an external memory card is one gigabyte. The device can manage memory cards up to a max of 32GBytes.



By starting the copy process an identification file with the required certificates for the recognition of the device as described in chapter 7.3.2.4 is also saved in the root directory of the SD card.

We take care of it.

---

In the display menu “memory” the progress of the copy process is shown.

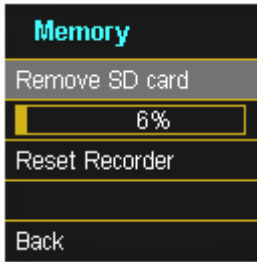

➡ To remove the memory card, operate the "Remove SD card" function.

The "Remove SD card" function stops the copying function for the measuring data of the internal memory to the SD memory card and releases the card for removal.

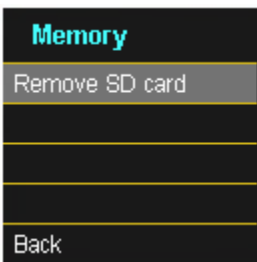

**NOTICE**

**Data loss!**  
Defect / loss of data due to incorrect operation

➡ Before removing the SD card, the "Remove SD card" function must be activated to ensure that no data is lost!

### ▶ Memory allocation

The memory allocation of the PQI-DA smart uses the internal 1 Gigabyte memory in a circular ring buffer for all measurement data.

The ring buffer is divided as follows:

- 512 MB circular memory for long-term measurement data
- 416 MB circular memory for fault records (oscilloscope images; ½ periods RMS values)
- 16 MB circular memory for log files and power quality events

## 6. Operation of the PQI-DA *smart*

### 6.1 Getting started

When the power analyser PQI-DA *smart* is put into operation for the first time, the instrument will appear in a guided "Wizard " mode. The operator is automatically guided through the initial commissioning of the instrument. This Wizard **must** be performed once after the PQ meter has been fully connected.



It is recommended to perform the wizard only after all wiring has been completed so that no incorrect measurement data is recorded due to the absence of measurement voltage, currents or parameters that have not been entered.



Since firmware version 2.0 the recording of the measurement data is only started after the complete completion of the wizard!

### 6.2 Initial Setup - Operation of the Assistant

The following actions can be performed using the navigation cross on the PQI-DA *smart*:



- ▶ **Arrow key right / down:**

Continue in wizard

- ▶ **Arrow key left / up:**

Back in wizard

- ▶ **Enter key :** 

Changing parameters

## 6.3 First commissioning - wizard - procedure

### ▶ Wizard page 1

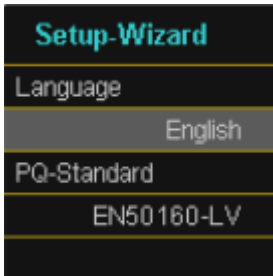

- Selection of display language PQI-DA *smart*
- Selection of the PowerQuality standard
  - Low-voltage grid => EN50160-LV
  - Medium-voltage grid => EN50160-MV
  - High-voltage grid => EN50160-HV

### PowerQuality Norm

Automatic basic settings and limit values for the following voltage level according to EN50160:

The selection of the voltage level has an influence on which measures should be recorded, on the thresholds and also at the IEC61850 Interface which data can be used at IEC61850 Interface.

### ▶ Wizard page 2

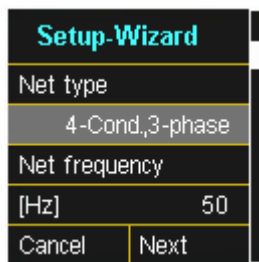

Basic settings / network connection PQI-DA *smart*

For more information about the network connection, see Chapter 5.6 Hardware connection

- **Net Type:**

Entering the grid type "3-conductor grid", "4-conductor grid" and/or "4 x 1 conductor grid" will determine how the Power Quality events are recorded.

Switch between 3-conductor and 4-conductor grids.

- In a 3-conductor grid, all events are calculated from the line-line voltages.
- In a 4-conductor grid and/or a 4 x 1 conductor grid all Power Quality events are determined from the line-earth voltages.

- **Grid frequency**

Setting grid frequency to 50Hz or 60Hz.

▶ Wizard page 3



**Voltage Transducer:** Corresponds to the ratio between the primary and secondary voltage.

**Current Transducer:** Corresponds to the ratio between the primary and secondary current.

**Example:**

Voltage: primary = 20,000V / secondary = 100V; conversion factor = 200

Current: primary = 100A / secondary = 5A; conversion factor = 20

If low voltage was selected in step 1, no voltage transformer ratio can be entered as the instrument can cover the entire range without transformer settings (0-690V LL).

▶ Wizard page 4

**Low Voltage System**

● **Reference voltage in low voltage**



Setting the reference voltage in the low voltage as conductor / earth voltage in volts.

The device automatically calculates the agreed conductor / conductor voltage!

**Example 1**

In 4-wire network = 230V conductor-earth voltage: V] P-N: 230.00

**Example 2**

In 4-conductor network = 500V conductor earth Voltage: V] P-N: 500.00

**Medium / High Voltage System**

● **Reference voltage in medium and high voltage**

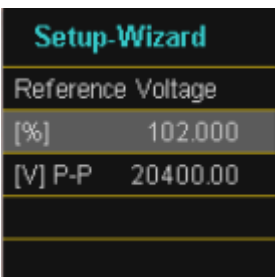

Adjustment of the **agreed** conductor / conductor Voltage in %

The setting must be done in percent. The device automatically calculates the agreed conductor / conductor voltage!

In the 3-wire network = 100V wire-wire voltage multiplied by the transformer factor

**Example 1:**

20.000V \* 102% = reference voltage 20400V.

This is the reference value for all trigger thresholds and power quality events.

▶ Wizard page 5

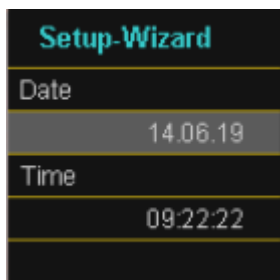

Manual entry of date and time as local time (UTC+1)



In the factory setting, the device is set to time zone UTC+1 with automatic winter time changeover. The time zone and summer/winter time changeover must be adapted to local conditions.

According to IEC61000-4-30, an external synchronization source such as NTP / DCF77 / GPS is required. The settings are described in chapter 7.4.8.

▶ Wizard page 6

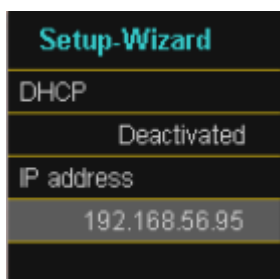

- **DHCP:**

**DHCP deactivated:** The device is used with a fixed IP address which have to be parameterized in the next step

**DHCP activated:** The device gets its IP-Address direct from a DHCP Server, which has to be reachable!

- **IP address:**

Entry of a fixed IP address as specified by IT

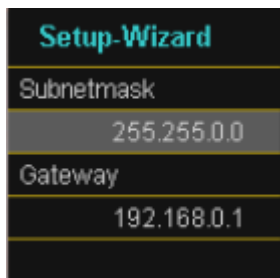

- **Subnetmask:**

Entering the subnet mask

- **Gateway:**

Entering a gateway



In the factory setting, the PQI-DA *smart* is factory pre-set with the IP address 192.168.56.95 and the subnet mask 255.255.0.0.

▶ **Wizard Page 7 (with Firmware >v2.0)**

● **Security Mode**

**Active: high security mode**

The device is set up in security mode. Communication is encrypted and device access is protected. The completion of the commissioning in security mode requires the setup of the necessary user accounts and must be completed with the software WinPQ or WinPQ lite with version 5.0 or higher. All details on encryption technology etc. are described in the security documentation.

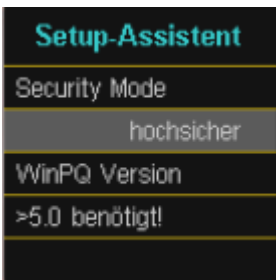

In any case, make a note of the serial number of your measuring instrument!

**Inactive compatible mode**

The installation of devices in compatibility mode results in a non IT-secure operation of the measuring device, if no other measures for the encryption of the connection are available in the used network (e.g. VPN solutions with encryption / disconnected network or similar), because neither the communication between WinPQ software and the PQ device is encrypted nor the device access is protected. This mode is intended for compatibility with WinPQ systems smaller than version 5 and systems with WinPQ versions 5 or higher should be operated in high security mode.



The separate security documentation for administrators describes all security-relevant system settings for setting up and operating the device and the entire PQ system (requirement of the BDEW Whitepaper).

▶ **Wizard Page 8**

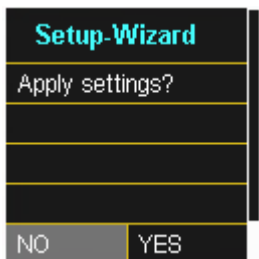

● **Accept settings:**

At this point all settings for the device can be accepted or the setup wizard can be cancelled.

If the wizard is aborted, the wizard will appear again and again each time the device is restarted because the necessary basic settings have not been made.

With the confirmation "Yes".

- restarts the device
- the device accepts all changes
- the device deletes all old measurement data in the device memory
- Many parameters are reset to factory settings.

The measurement campaign is started after the restart, all recorders are active.

We take care of it.

---

## 6.4 Display

The colour display of the device provides information about the correct connection of the measuring cables and transducers and shows online data for voltages, currents, total harmonic distortion (THD), power values and energy.

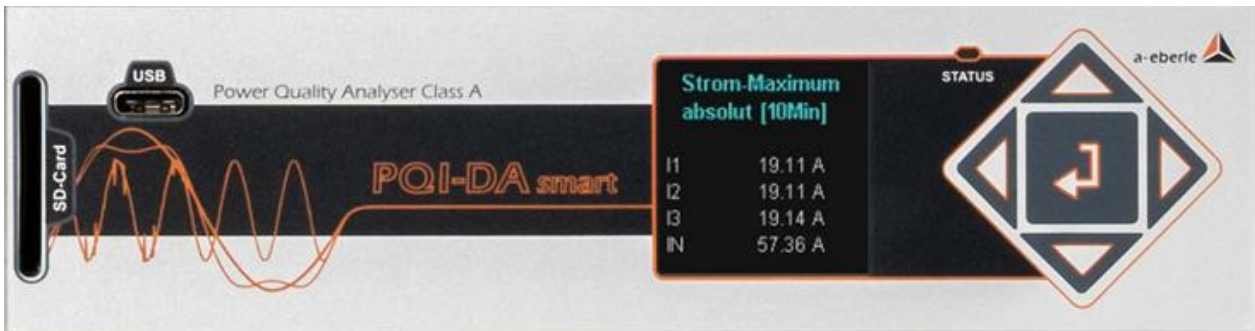

Pressing the "right" or "left" keys on the keypad will change the side of the display. If no key is operated, the screen will switch to sleep mode after 5 minutes.

The following screens provide online information of the measured data:

### Display page 1

Voltage L-N	
U1E	0.05 V
U2E	0.04 V
U3E	0.04 V
UNE	0.09 V

Line-Earth voltages

### Display page 2

Voltage L-L	
U12	0.02 V
U23	0.01 V
U31	0.01 V
F	0.00 Hz

Line-to-line voltages & grid frequency



Display page 3

Current	
I1	0.74 mA
I2	0.04 mA
I3	0.72 mA
IN	0.97 mA

Currents L1, L2, L3, N conductor

Display page 4

Current-Maximum (1 Tag)	
I1	7.80 mA
I2	0.01 mA
I3	6.61 $\mu$ A
IN	0.00 $\mu$ A

10 minutes maximum current for the last day

Display page 5

Current-Maximum (7 Tage)	
I1	7.90 mA
I2	0.01 mA
I3	6.65 $\mu$ A
IN	0.00 $\mu$ A

10 minutes maximum current for the last 7 days

Display page 6

Current-Maximum (30 Tage)	
I1	7.95 mA
I2	0.01 mA
I3	7.21 $\mu$ A
IN	0.00 $\mu$ A

10 minutes maximum current for the last 30 days

Display page 7

Current-Maximum absolute [10Min]	
I1	0.86 A
I2	0.87 A
I3	0.02 A
IN	1.19 A

10 minutes maximum current since the last rest

Display page 8

Active Power	
P1	9.07 $\mu$ W
P2	-0.00 W
P3	-0.00 W
<b>P</b>	<b>4.34 <math>\mu</math>W</b>

Active power including sign

Display page 9

Apparent Power	
S1	0.04 mVA
S2	1.63 $\mu$ VA
S3	0.03 mVA
<b>S</b>	<b>0.60 <math>\mu</math>VA</b>

Apparent output

Display page 10

Reactive Power	
Q1	0.04 mVAr
Q2	1.57 $\mu$ VAr
Q3	0.03 mVAr
<b>Q</b>	<b>0.07 mVAr</b>

Reactive power

Display page 11

Phi	
phi L1	0.000 $^{\circ}$
phi L2	0.000 $^{\circ}$
phi L3	0.000 $^{\circ}$

Phi - displacement angle (U/I) basic frequency

Display page 12

Power Factor	
PF1	1.000
PF2	1.000
PF3	1.000
<b>PF</b>	<b>1.000</b>

Power factor (active power / apparent output)

**Display page 13**

THD Voltage	
THD U1	0.00 %
THD U2	0.00 %
THD U3	0.00 %

Total harmonic distortion of voltages.

The THD calculation H2 to H40 and/or H2 to H50 is adjustable.

**Display page 14**

THD Current	
THD I1	0.00 %
THD I2	0.00 %
THD I3	0.00 %
THD IN	0.00 %

Total harmonic distortion of currents

The calculation H2 to H40 and/or H2 to H50 is adjustable

**Display page 15**

Active Energy	
Ep	0.00 kWh
Ep pos.	0.00 kWh
Ep neg.	0.00 kWh

Ep Total active energy

Ep pos. Active energy received (positive sign)

Ep neg. Active energy supplied (negative sign)

**Display page 16**

Reactive Energy	
Eq	0.00 kvarh
Eq pos.	0.00 kvarh
Eq neg.	0.00 kvarh

Eq Total reactive energy

Eq pos. Reactive energy received (positive sign)

Eq neg. Reactive energy supplied (negative sign)

**Display page 17**

PQ Smart	
Firmware	2.0.0
Build	13670
Date	14.06.19
Time	10:29
S/N	17042557
A/N	119.7501

● Device Information:

Current firmware PQI-DA *smart*

Build number

Date (local time)

Time (local time)

Serial number and article number

### Display page 18

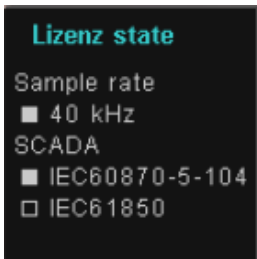

Display information about the license of this device.

In this example the PQI-DA *smart* has no IEC61850 communication licensed.

### Display page 19

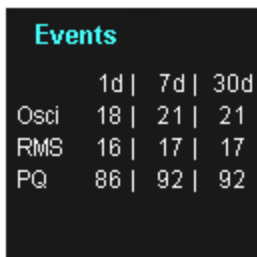

The number of PQ events that occurred, Oscilloscopic and RMS value recordings for the last day, last week and last month appear on the device display.



The event counter changes over to the following day at 00:00 hours/ 12 am each day.

### Display page 20



SSH RSA Fingerprint of the Puplic Key of the PQI-DA *smarts* for verification of the connection via the software WinPQ lite / WinPQ.

### Display page 21



SSH ECDSA Fingerprint of the Puplic Key of the PQI-DA *smarts* for verification of the connection via the software WinPQ lite / WinPQ.

Elliptic Curve Digital Signature Algorithm (ECDSA)

## 6.5 Setup display



Pressing the  key on the keypad will change the display to the setup menu.

The following main menus are available in setup mode:

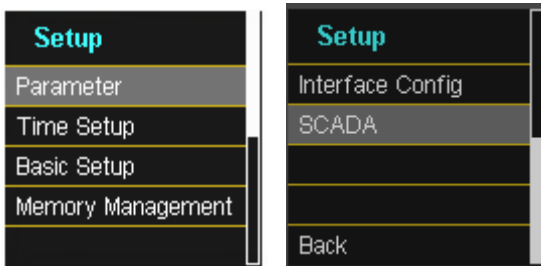

### 6.5.1 Parameter

#### ▶ Parameter page 1

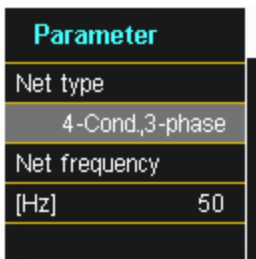

#### Grid configuration

Entering the grid type "3-conductor grid", "4-conductor grid" and/or "4 x 1 conductor grid" will determine how the Power Quality events are recorded.

Switch between 3-conductor and 4-conductor grids:

- In a 3-conductor grid, all events are calculated from the line-line voltages.
- In a 4-conductor grid and/or a 4 x 1 conductor grid all Power Quality events are determined from the line-earth voltages.

#### Grid frequency

Setting grid frequency to 50Hz or 60Hz. When used in DC networks, this parameter can be ignored.

▶ **Parameter page 2**

Parameter	
Voltage Transd.	1.00
Current Transd.	1.00

**Voltage converter:** Corresponds to the ratio between the primary and secondary voltage.

**Current transformer:** Corresponds to the ratio between the primary and secondary current.

**Example:**

Voltage: primary = 20,000V / secondary = 100V; conversion factor = 200

Current: primary = 100A / secondary = 5A; conversion factor = 20

▶ **Parameter page 3**

Parameter	
Nominal Voltage	
[V]	230
Reference Voltage	
[%]	100
[V] P-P	398.37

The displayed value for the nominal voltage is:

- In a 4-conductor grid = 230V line-earth voltage
- In a 3-conductor grid = 100V line-line voltage, multiplied by the conversion factor

The % value is used to set the reference voltage at a different value to the nominal voltage.



**Example 1:** 20,000V \* 105% = Reference voltage of 21,000V. This is the reference value for all trigger thresholds as well as Power Quality events.

**Example 2:** 500V grid (line-line) 230V \* 125% = 287.5V (line-earth)

▶ Parameter page 4

Parameter	
Nominal Current	
[A]	5
Reference channel	
	U1E

● **nominal current**

The nominal current is a quantity that the PQI-DA *smart* calculates from the current transformer data entered and the characteristic of the transformer set (C30/C31).

**Example:**

With a transformer with a secondary current of 5A - (feature C30/C31) and a transformer factor of e.g. 150, the rated current is:  $5A \times 150A = 750A$

● **Reference channel**

Defines the measuring channel for frequency measurements and grid synchronization.

▶ Parameter page 5

Parameter	
Power measurement	
	Standard
Flicker calc.	
	230V
Back	

**Power measurement:** The power calculation in the device firmware can be selected from two measuring functions:

- Power calculation in accordance with DIN 40110, part 2 – including the calculation of the imbalance reactive power (factory setting for the device).
- Simplified power calculation without considering the imbalance reactive power in the 3~ power.



This setting has an impact on the measured power values on the device display, the online measured values and the recorded measured values.

## 6.5.2 Time settings

The PQI-DA *smart* has various possibilities to synchronize the time in the device to the world time clock. A.Eberle recommends in any case to select a high-precision time synchronization variant and also to consider the quality of the time signal.

### 6.5.2.1 DCF77 time setting

The meter can obtain the time via an external DCF 77 clock (Germany / Austria restricted / Switzerland restricted). The following settings must be made in the menu.

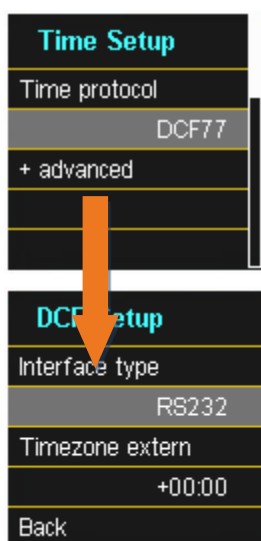

Time synchronization to an external DCF77 radio-controlled clock

DCF77 settings on the RS232/RS485 interface and the time zone of the DCF signal.

### 6.5.2.2 Connection DCF77 GPS Clock

To connect the DCF77 time clock art no. 111.9024.01 to PQI-DA *smart* please use this wiring.

**Connection DCF77 time clock:**



1: TxD → black wire time clock = -6V

2: RTS → red wire time clock = +6V

3: GND → white wire time clock = GND



4: RxD → green wire time clock = clock signal

- In extended mode, parameterize interface type RS232
- Time zone external: + x hours for time zone (time of data shown in the software)
- Time zone internally: + x hours for time zone (time of the PQI-*smart* display)

### 6.5.2.3 Manual time setting

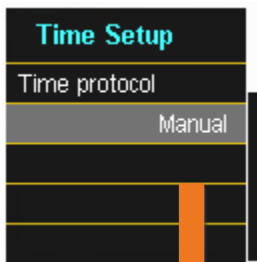

The time is set manually on the device

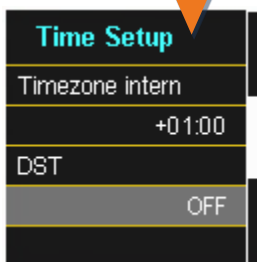

Summer / winter time setting is switched off (DST = OFF)

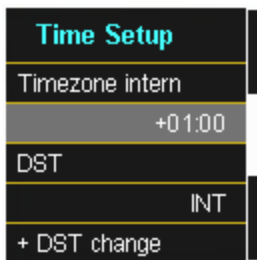

Setting the time zone in which the device is located

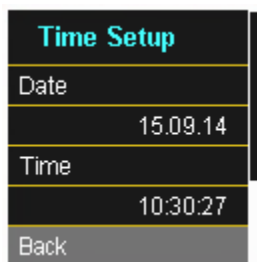

Manual time and date setting for PQI-DA *smart*



The PQI-DA smart internally converts the times into the UTC format using the times entered and the time zones entered. All stored measured values are in UTC.

It is therefore recommended to enter the time zones correctly!

### 6.5.2.1 Summer- Wintertime change (DST – Daylight Saving Time)

If the DST operating mode is set to **internal**, the summer/winter time changeover inside the PQI-DA *smart* takes place automatically each year. The PQI-DA *smart* use an internal algorithm with the following three parameters:

- **Day and month:** This is not specifically the date/month of the next change, but rather a method to specify **the week** in the month that the change is to occur on. Refer to the following examples.
- **Weekday:** The day of the week that the changeover always takes place on.
- **Time:** Time that the changeover will occur (the start of the changeover).

DST change	DST change
Summer > winter	Winter > summer
25.10.	25.03.
Sunday	Sunday
03:00	02:00
	Back

Menu for setting the parameters for daylight savings changes.

▶ **Example 1: Europe – Germany**

The changeover from **summer to wintertime** always takes place on the last Sunday in the month of October at 03:00 with the time changing back to 02:00 hrs.

The changeover from winter to summertime always takes place on the last Sunday in March at 02:00 with the time changing forward to 03:00 hrs.

	Summer to wintertime	Winter to summertime
<b>Date and Month :</b>	25.10	25.3
<b>Day</b>	Sunday	Sunday
<b>Time :</b>	03:00.	02:00.

These parameters cause the PQI-DA *smart* to:

- Change from daylight savings at 3 am on the Sunday that occurs **on or after** the 25.10, i.e. the first Sunday that occurs **on or following** the 25<sup>th</sup> of the month. As there are 31 days in October, the Sunday occurring **on or after** the 25<sup>th</sup> will always be the last Sunday of the month of October.
- Change to daylight savings at 2 am on the Sunday that occurs **on or after** the 25.3, i.e. the last Sunday of the month of March.

We take care of it.

---

► **Example 2: Australia – New South Wales**

The changeover from **summer to wintertime** takes place on the first Sunday in the month of April at 03:00 with the time changing back to 02:00 hrs

The changeover from **winter to summertime** always takes place on the first Sunday in the month of October at 2:00 with the time changing forward to 03:00 hrs.

	Summer to wintertime	Winter to summertime
<b>Date and Month :</b>	25.10	25.3
<b>Day</b>	Sunday	Sunday
<b>Time :</b>	03:00.	02:00.

These parameters ensure for all future years that the changeover from summer to wintertime is always performed automatically by the PQI-DA *smart* on the first Sunday **on or after** 01.4 and the change from winter to summertime is always performed on the first Sunday **on or after** 01.10.

### 6.5.2.2 NTP time setting

The PQI-DA *smart* has the possibility to synchronize itself with the Network Time Protocol (NTP) to an existing NTP server in the network. The used NTP server should be able to deliver a high time signal quality.

Synchronization to SNTP server is possible, but not recommended due to high inaccuracies.

Time synchronization to a NTP time server

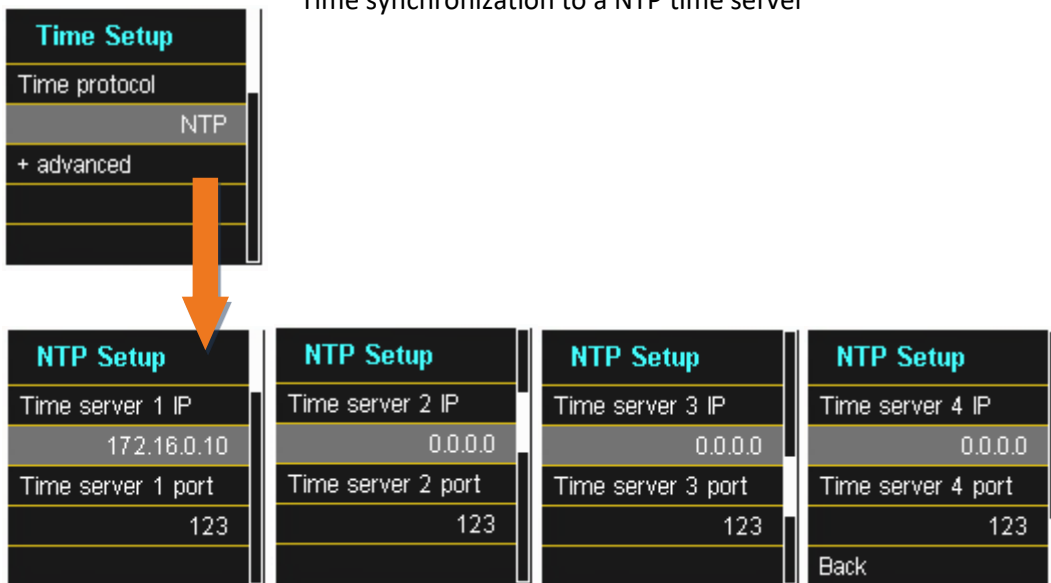

The PQI-DA *smart* supports up to four time servers in the network. The device automatically uses the strongest signal that is available in the network.



The port for the NTP server is, by default, "123" NTP and must be accessible from the device to the NTP server.



It is recommended to use an NTP server with a stratum of at least 8. All NTP servers with a higher stratum are ignored by the device.

See also: [https://de.wikipedia.org/wiki/Network\\_Time\\_Protocol](https://de.wikipedia.org/wiki/Network_Time_Protocol)

### 6.5.2.3 NMEA-ZDA time setting

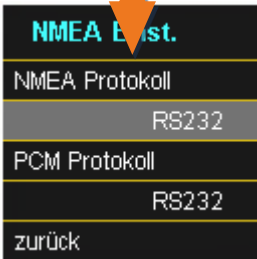
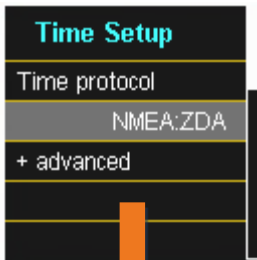

Setting up the RS232/RS485 interface for the NMEA protocol

### 6.5.2.4 NMEA-RMC time setting

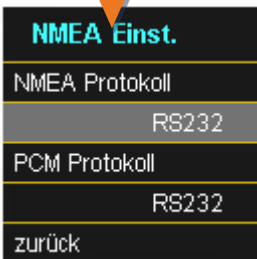
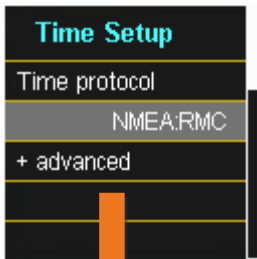

Setting up the RS232/RS485 interface for the NMEA-RMC protocol

### 6.5.2.5 IRIG-B time setting

Time codes between instrument groups, commonly known as IRIG time codes, are standard formats for transmitting time information. Atomic frequency standards and GPS receivers designed for precise timing are often equipped with an IRIG output.

The PQI-DE has with the COM 2 interface a possibility to use the precise IRIG B format for time synchronization.

On the PQI-DE, the correct format IRIG-BXX0..3 or IRIG-Bxx4-7 must be selected, as well as the time zone of the synchronised time, so that the PQI-DE can internally store the measurement data with a correct UTC time stamp.

IRIG-B formats 0 to 3

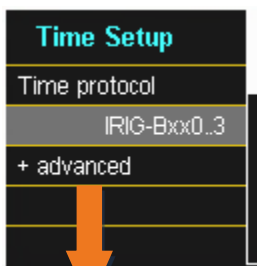

IRIG-B formats 4 to 7

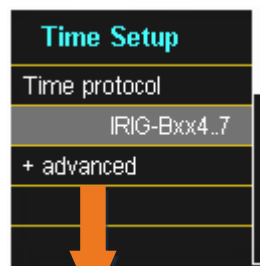

Selecting the IRIG-B format

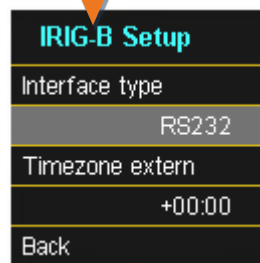
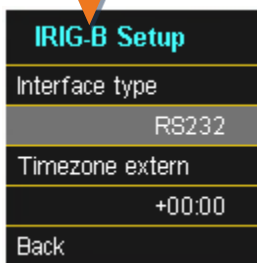

Setting up the interface and the time zone

### 6.5.2.6 IEEE 1344 time setting

IEEE 1344 is a standard that defines parameters for synchrophasors for energy systems. The standard extension of the IRIG-B time code includes year, time quality, summer time, local time offset and leap second information.

In addition to the IEEE1344 protocol, the interface must also be selected on the PQI-DE, as well as the time zone of the synchronized time, so that the PQI-DE can internally store the measurement data with a correct UTC time stamp.

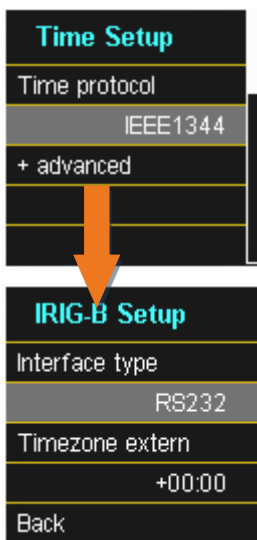

Time synchronization to an IRIG-B time protocol (in accordance with IEEE1344)

Setting up the interface and the time zone

### 6.5.3 Basic setting

#### ▶ Basic setting page 1



**Language:** Select the display language

**Auto setup:** This function takes you through an automatic device setup. This function is started automatically when the device is put into operation for the first time and does then not appear again. You can go to the guided setup at any time via "Auto Setup".



When **Auto setup** is performed, all the data saved on the meter is deleted. In addition, the complete set-up is reset to the factory state, except for the changes made in the wizard itself.

#### ▶ Basic setting page 2

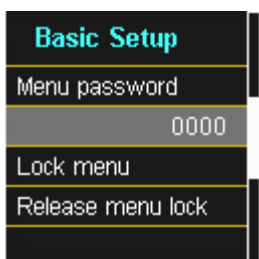

Access to the device setup can be disabled via a 4-digit password.

- Enter a four digit passkey
- Activate with "Lock menu"

#### ▶ Basic setting page 3

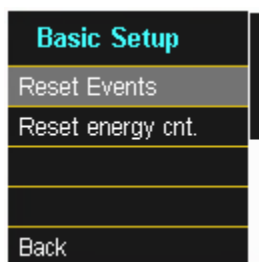

**Reset events:** The event counter for sequence of events recordings and PQ events on the device display is reset to 0. All measurement data and PQ events are retained in the device memory.

**Reset energy counter:** The energy counters in the device display and in the device memory are set to 0.

**Reset I max current:** The absolute maximum current value can be reset here.



## 6.5.4 Password lock device display

Access to the device setup can be disabled via a 4-digit password.

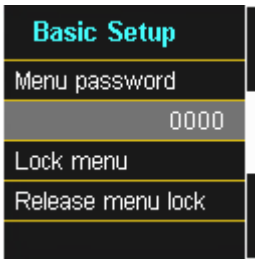

If a password is assigned, no access to the device set-up via the display is possible



- Enter your correct password
- Confirm with unlock

Now the device setup over the keys and the display can be achieved. The password has no restriction for the software.

### 6.5.5 Memory management

The "Remove SD card" function stops the copying function for the measuring data of the internal memory to the SD memory card and releases the card for removal. (See also chapter 5.8.4.1)

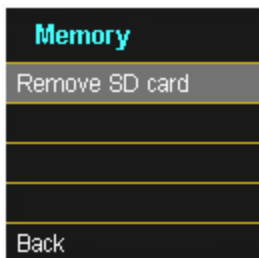

### 6.5.6 Setting up the device interfaces



In the factory setting, the PQI-DA *smart* is factory pre-set with the IP address **192.168.56.95** and the subnet mask **255.255.0.0**.

#### ▶ Interfaces page 1

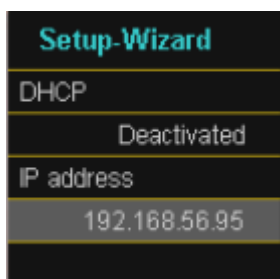

- **DHCP:**

**DHCP deactivated:** The device is used with a fixed IP address which have to be parameterized in the next step

**DHCP activated:** The device gets its IP-Address direct from a DHCP Server, which has to be reachable!

- **IP address:**

Entry of a fixed IP address as specified by IT

#### ▶ Interfaces page 2

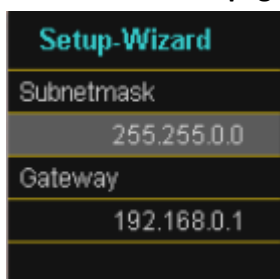

- **Subnetmask:**

Entering the subnet mask

- **Gateway:**

Entering a gateway

## 7. WinPQ lite Software

The free WinPQ lite evaluation software has been developed exclusively for the Network Analyser PQI-DA and PQI-DA *smart* and includes the following functions:

- Set-up of the Network Analyser PQI-DA *smart* und PQI-DE
- Online analysis of the measurement data
- Reading the measurement data from the measuring device
- Evaluating measurement data
- Firmware update for PQI-DA *smart* und PQI-DE
- Calibration of Power Quality Analysers (Option)



The powerful **database and evaluation software WinPQ** which is available at an extra charge supports all mobile and permanently installed Network Analysers supplied by A. Eberle in one system. Measuring data from different devices can be compared to each other. There is a fully automated and permanent connection to all permanently installed devices. Detailed Power-Quality reports and sequence of events recording are automatically created by the system and can be sent via e-mail. There are separate operating and commissioning instructions for the WinPQ software.

### 7.1 Installing the evaluation software

To start the installation of the evaluation software, place the installation CD in your CD-ROM drive. If the Auto start function is activated, the installation program starts automatically. Otherwise, go to the root directory of your CD-ROM drive and start the program by double-clicking the file  SETUP.EXE .

The installation complies with the Windows standard, including uninstalling the program system via the "Software" option on the Control Panel. The installation location of the program (target directory) can be freely selected during installation.

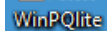

The start icon  is created automatically on your PC's Desktop.

We take care of it.

---

► **Uninstalling the software via the control panel**

The components are removed from the PC using Windows "Control panel".

Via "Software", "WinPQ lite" entry, use the "Remove" button to delete the evaluation software.

All parts of the program, including the generated links, are completely removed after a single confirmation. Before uninstalling the program, the components launched must be closed.

► **Software Update**

The evaluation software as well as all updates and current device firmware can be found free of charge on our website at the product group "Power Quality / Software WinPQ lite". [www.a-eberle.de](http://www.a-eberle.de)



Please also install the current device firmware on your measuring device to ensure that you can use any new functions.

**Start screen for WinPQ lite, example with three PQI-DA smart devices**



## 7.2 Basic setting for Software

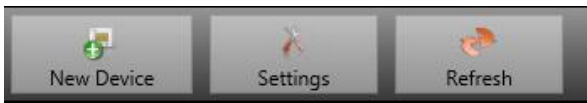

The following changes are possible under the menu item "Options":

### ▶ General Settings

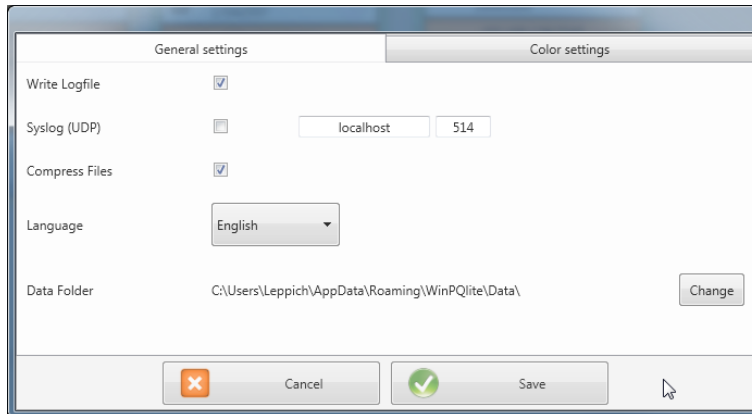

- Write log file: Software messages are logged in a file.
- Syslog (UDP): The logbook messages are also transmitted via syslog protocol via the network.
- Software language setting (SW must be restarted after a change)
- Data folder:  
Folder in which all measurement data are stored. This can be individually adapted to your own folder structure, for example to store the measurement data of the PQI-DA *smarts* on D:\measurement data\.

### ▶ Colour Settings

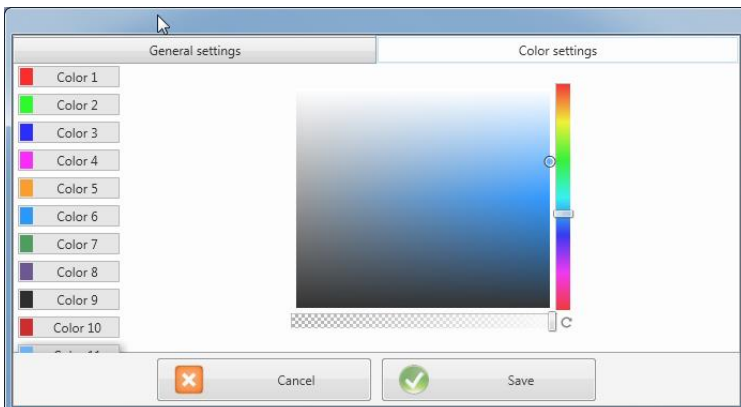

Individual colours can be used to display the measurement data.

The colours are used in the order of the clicked measurement data.

We take care of it.

---

## 7.3 Setting up a new PQI-DA smart

Via the function "New device" an assistant is called up which creates the measuring devices as a tile on the WinPQ lite Desktop and also completes the commissioning of the device.



For a fully secure connection, the "IT Security Guide PQI-DA smart for Administrators" must also be observed in addition to these operating instructions!

### 7.3.1 Creating a device tile

Since the A.Eberle devices with firmware version 2.0 or higher have several modes due to the increased IT security requirements, it is necessary to differentiate when adding encoders to the WinPQ lite software.

Under the following conditions, a device can be created in the WinPQ lite software without further actions:

- A device with a firmware version lower than V2.0 is present.
- A device with firmware V2.0 and switched on compatibility mode is present.
- There is a device with firmware V2.0 and already setup user administration.

If none of the above requirements are fulfilled, the measuring instrument is not yet completely set up. The instructions in Chapter 6.2 must be followed in order to completely setup the device.

#### 7.3.1.1 Wizard Step 1 - Device Selection

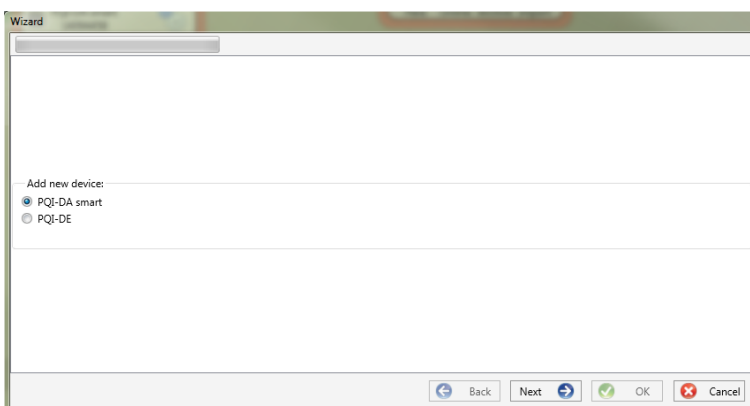

#### Device selection:

- PQI-DA smart



- PQI-DE



### 7.3.1.2 Wizard Step 2 - Device Setup

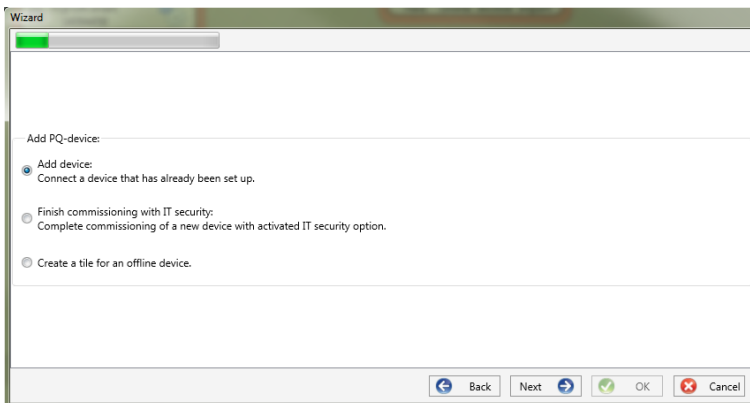

**Selection for a device according to the requirements listed above is**

"Connect device that's already been set up."

### 7.3.1.3 Wizard Step 3 - Device Mode

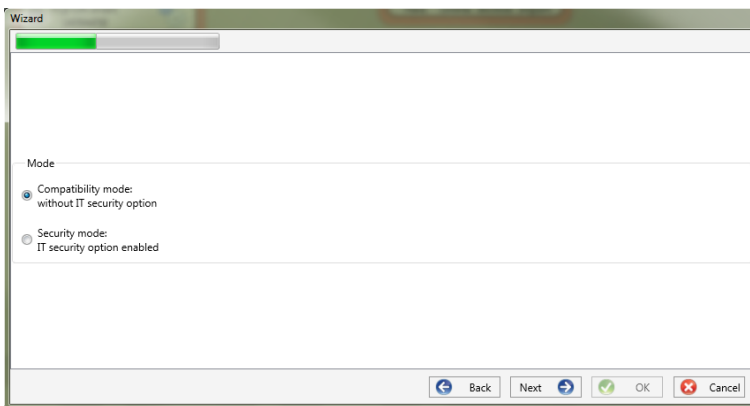

**Selection of the procedure for finishing the devices - Security settings:**

- Compatibility mode

The TCP/IP communication to the device is unencrypted.

- Security mode

The TCP/IP communication device is encrypted using the SSH protocol.

### 7.3.1.4 Wizard Step 4 - Device Connection

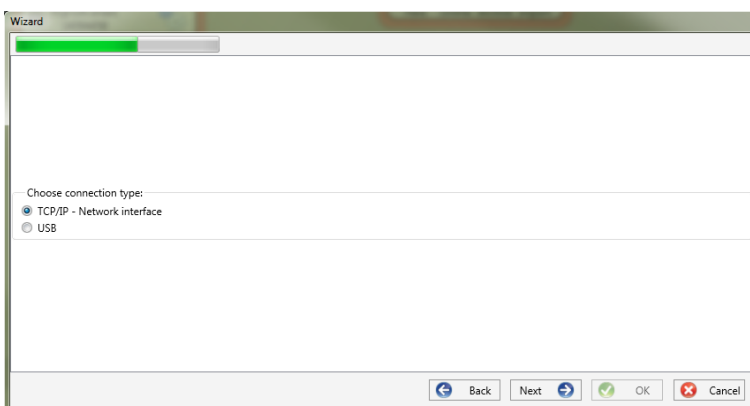

**Selection of connection**

The device can be connected via USB or TCP / IP (network) communication.

If the USB interface is used, it must be selected in the following step.

### 7.3.1.5 Wizard Step 5 - IP Version

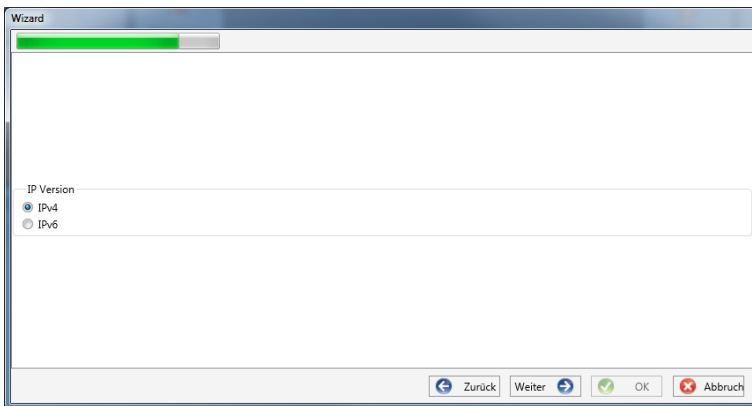

#### Selection of IP version

A distinction can be made between IPv4 and IPv6. IPv6 is currently only supported via gateways.

The default connection is IPv4.

### 7.3.1.6 Wizard Step 6 - IP Address

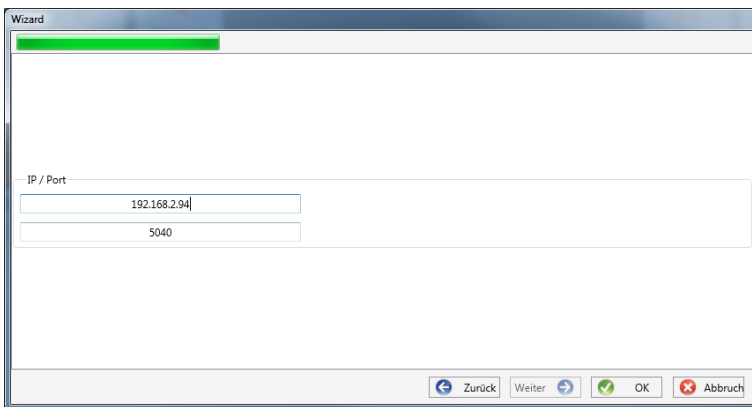

#### IP address of the measuring instrument:

Enter the IPv4 address and the connection port of the encoder.

The default port after completion of the wizard in 6.3 depends on the selected mode:

- Security mode: Port 22
- Compatibility mode: Port 5040

Click "OK" to accept the values and create a tile for this device on the software interface. Any number of devices can be created.



## 7.3.2 Completing the Instrument Wizard in Safety Mode

If the setup of the meter was performed in "Safety Mode" as described in 6.2, the meter will display the following screen after restarting until the setup is complete:

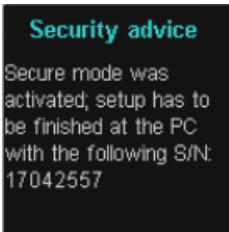

At the end of commissioning in safety mode, a user database is created on the device in which all information on users, their roles and the associated rights are stored.

In order to create individual users for the device in this database, it is necessary to execute the commissioning assistant via the "New device" button.

The device is selected as described in Section 7.3.1.1.

### 7.3.2.1 Security Wizard - Completion

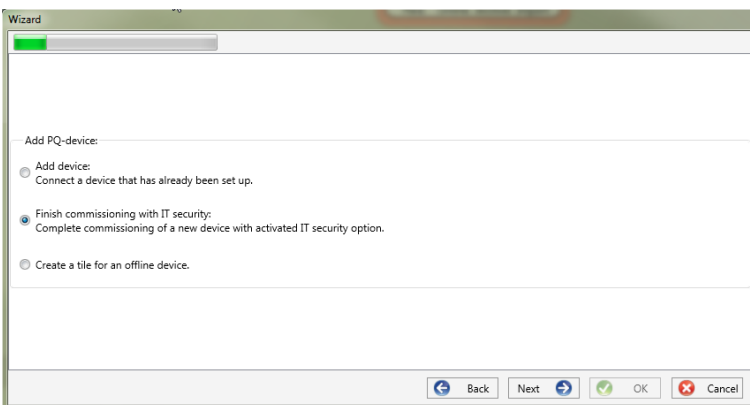

Selection to complete all security settings:

"Completion of commissioning with IT security".

### 7.3.2.2 Security Wizard - Procedure Selection

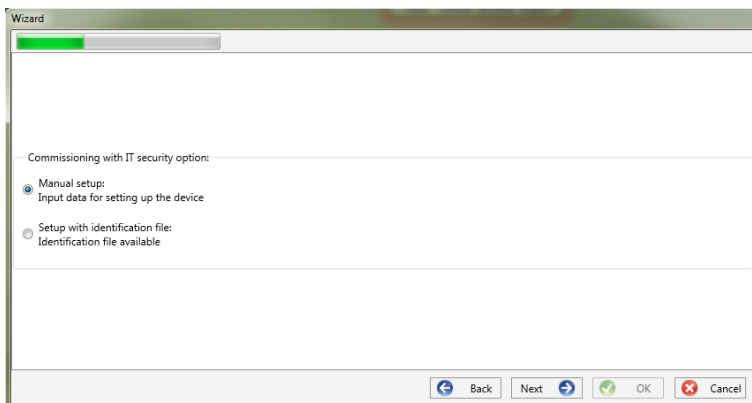

Selection of the procedure for completing the devices - Security settings:

- Manual setup (chapter 7.3.2.3)  
Manual entry of all data such as IP address / serial number of the device
- Identification file (chapter 7.3.2.4)  
Use of an identification file made available by the device

We take care of it.

---

### 7.3.2.3 Security Wizard – Manual

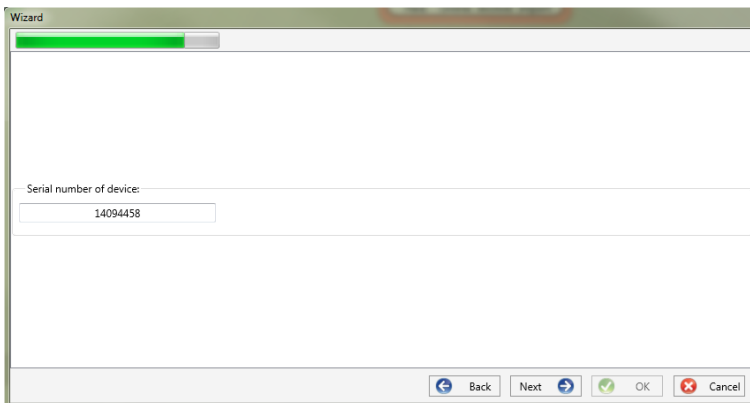

For setup, the serial number of the instrument must be known and entered in the field to establish the first connection via an encrypted connection to the instrument.

### 7.3.2.4 Security Wizard - Identification File

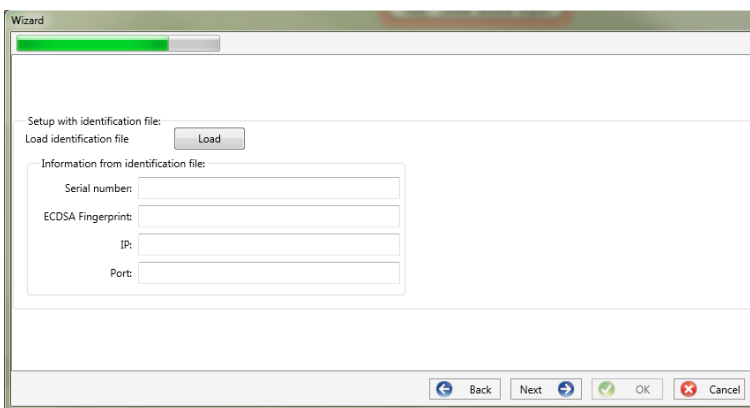

If the option "Identification file" was selected in Chapter 7.3.2.2, the \*.aei file, which is provided by the instrument via an SD card (Chapter 5.8.4.1), must be selected via "Open".

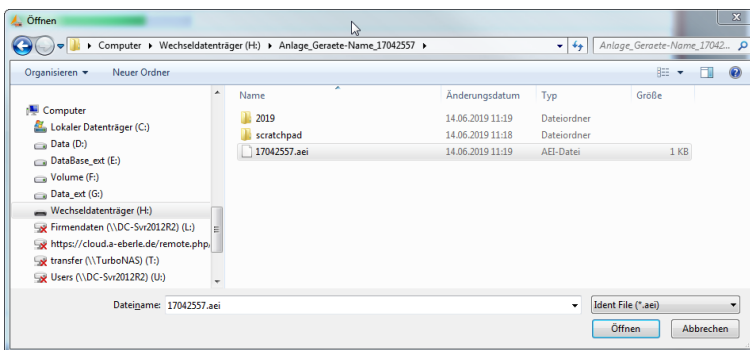

The \*.aei file contains all information such as serial number, ECDSA fingerprint, IP address and the port parameterized on the encoder. It can be found on the SD card in the main directory of the measuring instrument.

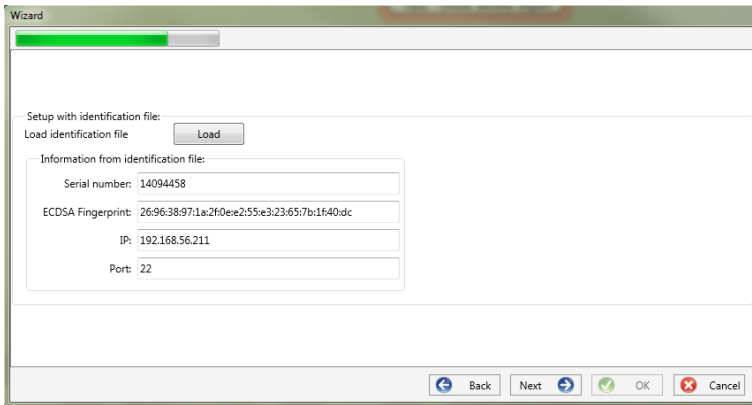

After the file has been selected, all information required for the connection is automatically entered.

In any case, the ECDSA fingerprint must be compared with the fingerprint on the measuring device before clicking Continue in order to uniquely verify the identification!

Click "Next" to download the password guidelines from the meter.

### 7.3.2.5 Security Wizard - User Setup

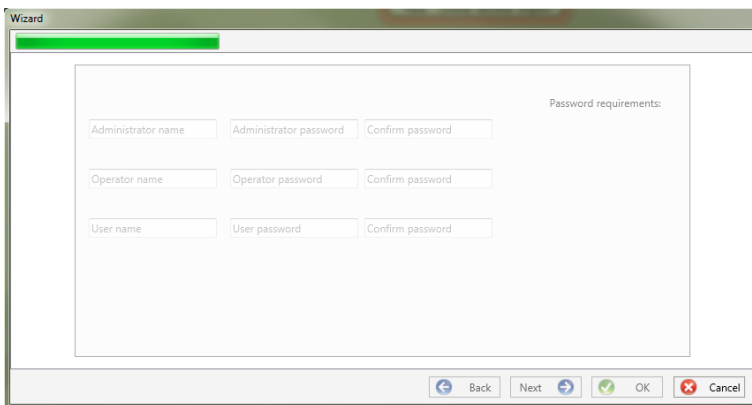

For each of the three roles defined (administrator, operator, user), the device requires a user who must be entered together with a password.

Depending on the password policy, a password that complies with the company's IT policy is required.

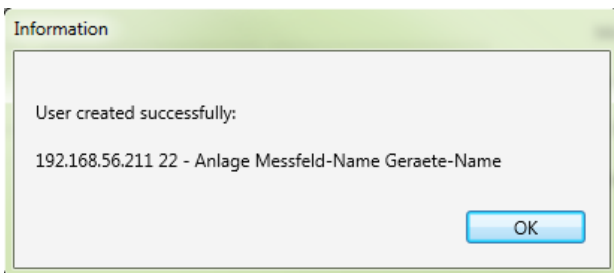

If all users have been successfully created and transferred to the meter, the following message appears "User successfully created!"

Commissioning in high-security mode is now complete.



The detailed description of rights and roles with specification of rights is listed in the security documentation.



In addition to the three standard users per role, further users can be created in the measuring instrument. The settings are described in chapter (9).

### 7.3.3 Deleting a device tile

Device tiles can be deleted via the "Setup general" device menu.

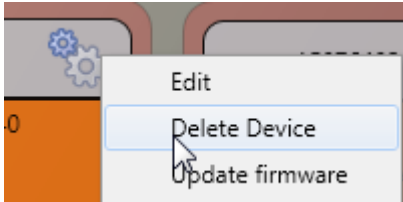

## 7.4 Device setup

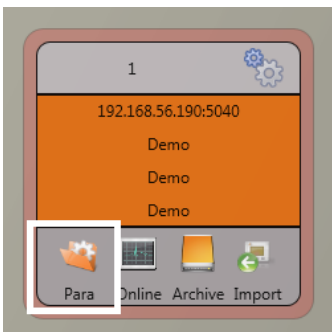

The PQIDA *smart's* parameter setup can be accessed via **para** button on the device panel. Parameters can be set in basic or expert view, which is also referred to as the classic view in the following sections. These views can be switched by choosing the corresponding selection field in the right main menu of the parameterization window.

The **main menu** (fig. right) is displayed in the right area of the parameterization window. The **parameters menu** with selectable parameter groups is shown in the left window area (fig. bottom right).

## 7.4.1 Main Menu: Views and functions

The **basic view** allows application-driven parameterization of the device; the **classic expert view** shows the parameter structure of the device in list form and is described in Section 7.5. The service view should only be used for parameterizations in cooperation with the A-Eberle service team. Incorrect parameterizations can lead to malfunctions!

Via **Send** button, the previously defined parameters are sent to the device. The buttons **open templates** or **open custom templates** can be used to load different standard templates or custom parameter sets.

- Low voltage network according to EN50160 and trigger settings
- Medium voltage network according to EN50160 and trigger settings
- High voltage network according to EN50160 and trigger settings
- IEEE519 for different voltage levels

Via **save** button, settings are saved to an XML file. The "**Factory settings**" option resets all settings on the device with the exception of the network, connection and license settings to the factory settings.

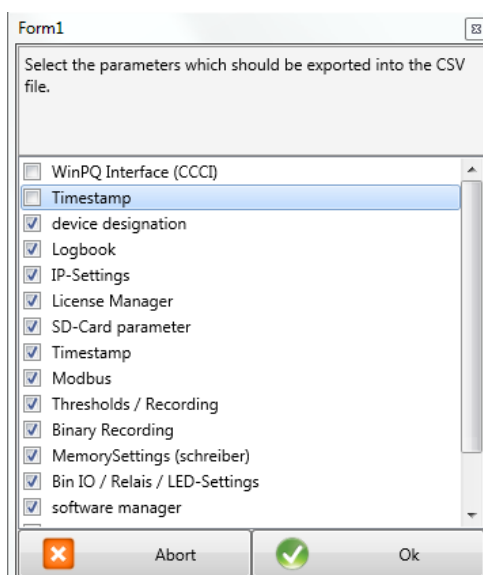
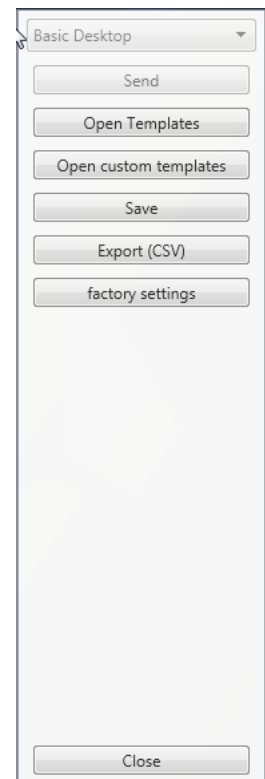

Selection dialog for exporting the desired data

36		
37	Frequency	50
38	Frequency ripple signal voltage [Hz]	168
39	Flicker bulb	1
40	Normalized voltage L-L-Sp. [percent from UNOM]	100
41	hysteresis 1/2-Perioden-voltage [percent from UC bzw. UC/:	1
42	tolerance band fast voltage change RVC, dd [percent from UC	1
43	[dmax]-threshold fast voltage change RVC [% from UC bzw.	6
44	threshold voltage dip (Dip) [percent from UC bzw. UC/1.73]	90
45	threshold voltage swell (threshold) [percent from UC bzw. U	110
46	threshold voltages interruption [percent from UC bzw. UC/1.	5
47	lower threshold 10s- network frequency /Hz	49,5
48	higher threshold 10s-Total network frequency /Hz	50,5
49	lower threshold 10min-voltage [percent from UC bzw. UC/1.	90
50	higher threshold 10min- voltage [percent from UC bzw. UC/1	110
51	threshold 10min-THD [percent]	8
52	threshold 10min-voltages unbalance [percent]	2
53	threshold short time flicker PST	1
54	threshold long time flicker PLT	1
55	threshold 3 Sec -ripple signal voltages [percent from UC bzw.	9
56	Trigger-threshold 200ms-ripple signal voltage recorder [perc	1
57	limit table 10min-voltages harmonic (H2) [percent]	2
58	threshold 10min-voltages harmonic (H3) [percent]	5
59	threshold 10min-voltages harmonic (H4) [percent]	1
60	threshold 10min-voltages harmonic (H5) [percent]	6
61	threshold 10min-voltages harmonic (H6) [percent]	0,5
62	threshold 10min-voltages harmonic (H7) [percent]	5
63	threshold 10min-voltages harmonic (H8) [percent]	0,5
64	threshold 10min-voltages harmonic (H9) [percent]	1,5
65	threshold 10min-voltages harmonic (H10) [percent]	0,5
66	threshold 10min-voltages harmonic (H11) [percent]	3,5

Example of a CSV file in Excel

After resetting the PQI-DA smart to factory settings, the assistant must be executed again! All measurement data will be deleted from the device after the wizard has been executed! **Close** closes the parameterization last. Changes that are not saved will be lost!

## 7.4.2 Parameter Menu: Device parameters and settings

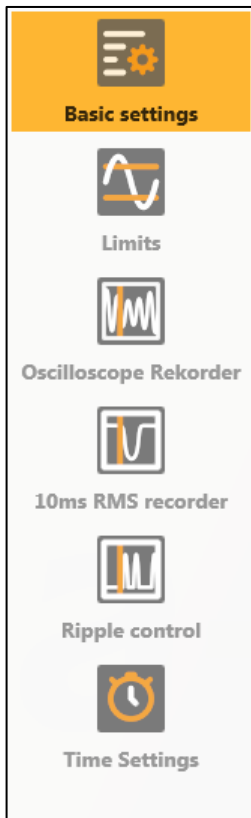

The device parameters and settings are divided into functional groups and can be selected in the left window area (see fig. left). These are explained in more detail in the following sections. The different parameters are partly dependent on each other as well as on the loaded or selected template when the device has been commissioned.

Further explanations of the various setting values can be found in the next chapter 7.5.

## 7.4.3 Basic Settings

All main settings can be found into the basic settings window.

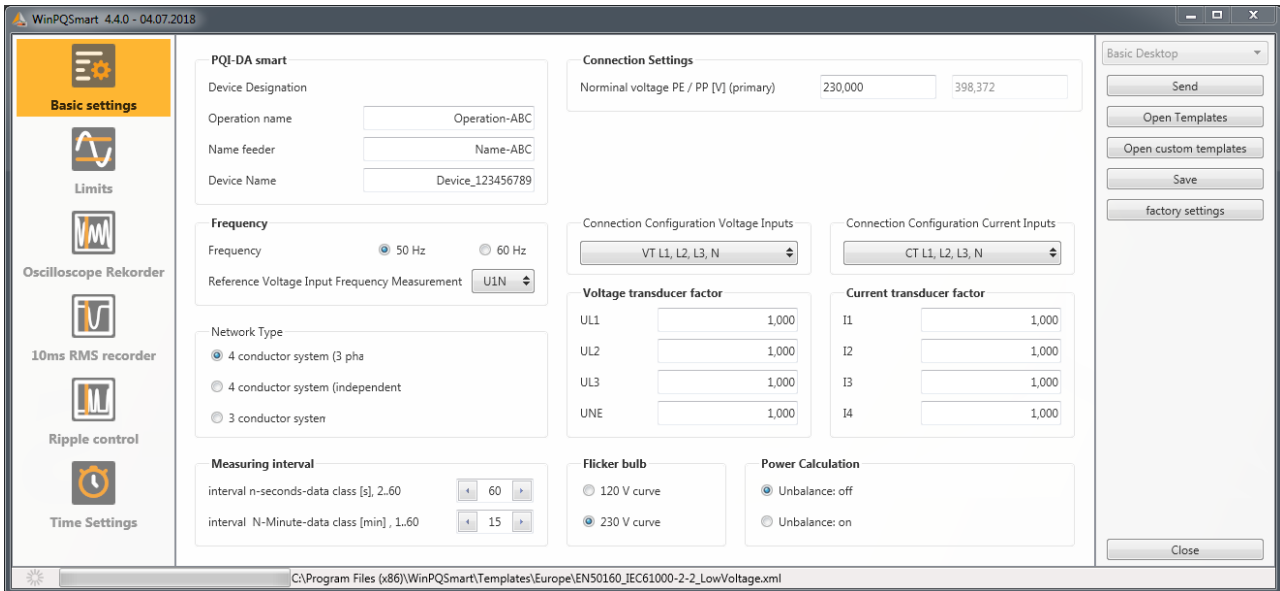

To provide a clear overview, all parameters are bundled into functional groups.

### 7.4.3.1 Pqi-DA smart

All device identifiers can be entered here for a clear assignment of the Pqi-DA *smart*. These identifiers are used for presentation in the WinPQ lite interface, when copying data to an SD card (folder name) and also for unique assignment into the WinPQ database.

### 7.4.3.2 Connection Settings

Nominal voltage (conductor-earth) in volts is defined here (primary). The Pqi-DA *smart* refers all trigger thresholds or PQ events to the set nominal voltage. The nominal voltage in the 3-wire network is the agreed conductor-conductor voltage, e.g. 20400V. In 4-wire network, the conductor-ground voltage is specified, e.g. 230V.

### 7.4.3.3 Frequency

Selection of the grid frequency and selection of the reference voltage input for frequency measurement

### 7.4.3.4 Network Type

Selection of the network type:

If a 3 conductor system has been selected, all evaluations of standard EN50160 are calculated based on the conductor-conductor voltages. In 4 conductor system, all power quality parameters are determined from the conductor-ground voltages. Choosing 4 conductor system with independent phases, the power values of the individual phases are calculated separately.

#### 7.4.3.5 Connection configuration of voltage and current inputs

Selection of the connection configuration and the voltage transformer factors.

Enter the ratio of the current and voltage transformers to which the power analyser is connected in the transformer settings.

Example:

- Voltage: primary = 20.000V; secondary = 100V; conversion factor UL1 = 200  
Current: 100A / 5A = conversion factor = 20

#### 7.4.3.6 Measuring interval

Configuration of the two adjustable recording intervals N-seconds and N-minutes. In addition to the class A measurement intervals, numerous values can be recorded by the PQI-DA *smart* at freely adjustable intervals. For example, this can be used for the measurement of maximum power in the 15 min interval. The intervals are always synchronic to full hours.

#### 7.4.3.7 Flicker-Curve-Lamp model

Select the lamp model for a 120V or 230V flicker curve. In 120 V systems (e.g. America), a different flicker curve is specified than in a 230 V system (e.g. Europe).

#### 7.4.3.8 Power calculation

Selection of the power calculation with or without unbalance.

The various types of reactive power can be switched on or off as required. This has an influence on the calculation of the collective reactive power as well as the apparent power.

- **Unbalance: On**

Power calculation according to DIN40110 Part 2 - with calculation of the unbalance reactive power and the modulation reactive power is the default setting of the device. This Adjustment is strongly recommended for measurements on the transformer stations.

- **Unbalance: Off**

Power unbalance is not considered in the calculation of reactive power.

This setting has an influence on the measured power values of reactive and apparent power in the display, the online measured data and the recorded measured data as well as in process controlling.



## 7.4.4 Limits

In this menu, all limit values of the currently set standard or loaded standard template are preselected. The compatibility levels can be changed by the user. This setting has a direct influence on the standard reports!

6.4.3 It is recommended to work with standard templates!

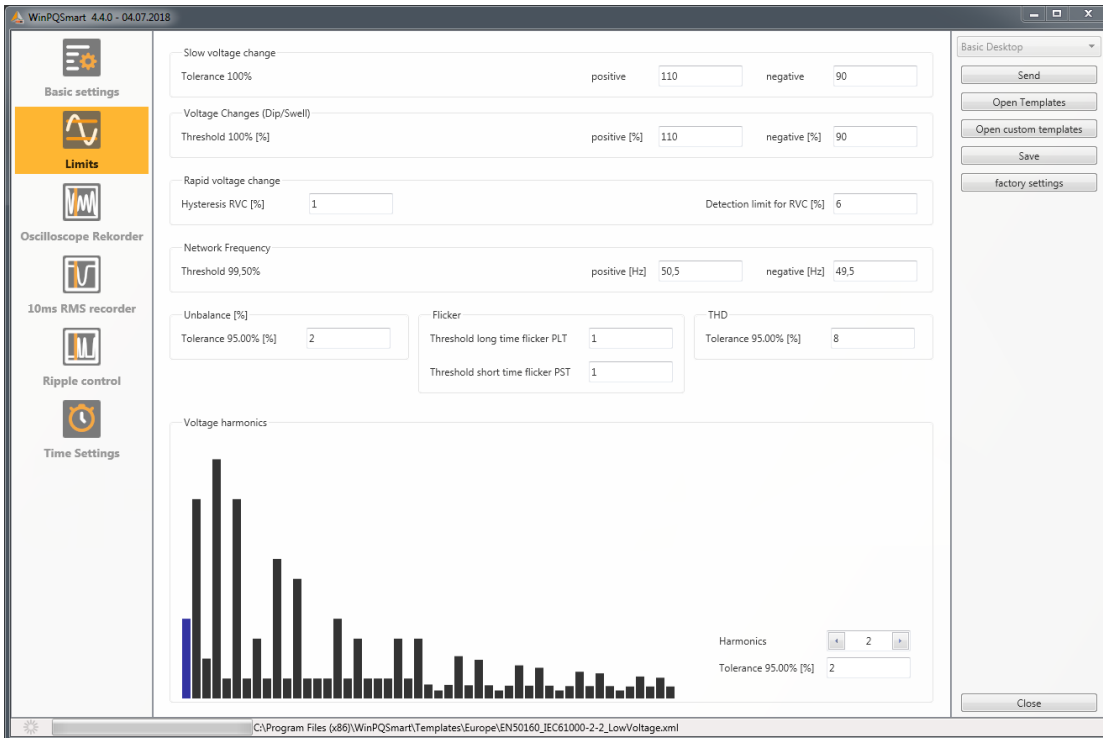

For a clearer overview, all parameters are organized in functional groups. The various (physical) quantities and their calculation methods are defined and described in chapter 14.

- ▶ **Voltage changes**  
Limits for slow voltage changes and fast voltage changes (for details see the respective standard).
- ▶ **Frequency**  
Upper and lower limit value of the permitted frequency deviation in relation to the set grid frequency.
- ▶ **Unbalance**  
Limit value for unbalance.
- ▶ **Flicker**  
Limits of long and short-term flicker.
- ▶ **THD**  
Limits of the Total Harmonic Distortion.
- ▶ **Voltage harmonics**  
Limits of voltage harmonics with direct selection.

## 7.4.5 Oscilloscope Recorder

The trigger conditions and thresholds, i.e. trigger criteria for oscilloscope recorder, as well as other settings of the oscilloscope recorder can be set in this menu. In default configuration, an effective value threshold of +10% and -10% of the nominal voltage is defined.

For a clearer overview, all parameters are organized in functional groups. If a field is greyed out and/or not selected, this trigger criterion is not active or cannot be activated. The parameters of the current trigger can be displayed either absolute or as percentage value of the nominal current (setting in the basic configuration).



The trigger thresholds of the oscilloscope and RMS recorder are not completely independent. All common parameters are automatically adjusted in both recorders.

#### **7.4.5.1 Voltage and current trigger**

In general, the trigger thresholds refer to the nominal voltage, e.g. 230 V or 20400 V, which has been set in the basic settings.

If the voltage/current value (10ms RMS value) falls below the lower trigger threshold or exceeds the upper trigger threshold, a recording is started as well as in case of RMS value jump or phase jump.

The envelope trigger starts a recording in case of a so-called sinus violation. Thereby the device detects a violation of sampling points with respect to the configured envelopes of the sinusoidal curve (e.g. commutation dips). In practice, a setting in the range of 10 to 25% (of the nominal voltage) is usually recommended.

#### **7.4.5.2 Symmetrical Components Trigger**

A record is started in case of the specified symmetrical component thresholds are violated.

#### **7.4.5.3 Frequency Trigger**

The frequency trigger starts a recording in case of shortfall or overrun of the set frequency limits as well as in case of a frequency jump within a second.

#### **7.4.5.4 Binary Trigger**

A record is started in case of an external trigger via software or a falling or rising edge at binary input 1 or 2.

#### **7.4.5.5 Recorder length and Pre-event time**

The recorder length specifies the total time frame of the oscilloscope recorder in milliseconds. Pre-event time is defined as the time that passed before a (trigger) event occurred and is also recorded.

The PQI-DA *smart's* fault recorders provide a minimum recording length and a maximum re-cording length. Thereby, the minimum recording length is extended up to the maximum recording length, depending on the trigger condition. This function offers the possibility to reduce data due to short events as well as to record very long events ensuring an effective use of data storage!

### 7.4.5.6 Active / passive trigger:

Active triggering occurs, if e.g. the voltage drops from desired to undesired state.

Passive triggering allows triggering the transition from undesired to desired state e.g. after voltage interruptions.

This feature offers the possibility to record very long earth faults with an enormous data reduction, since both the beginning and the end of the event can be recorded entirely, without the obligation to record the whole event!

► **Example 1: Single fault with activated " active " and " passive " trigger**

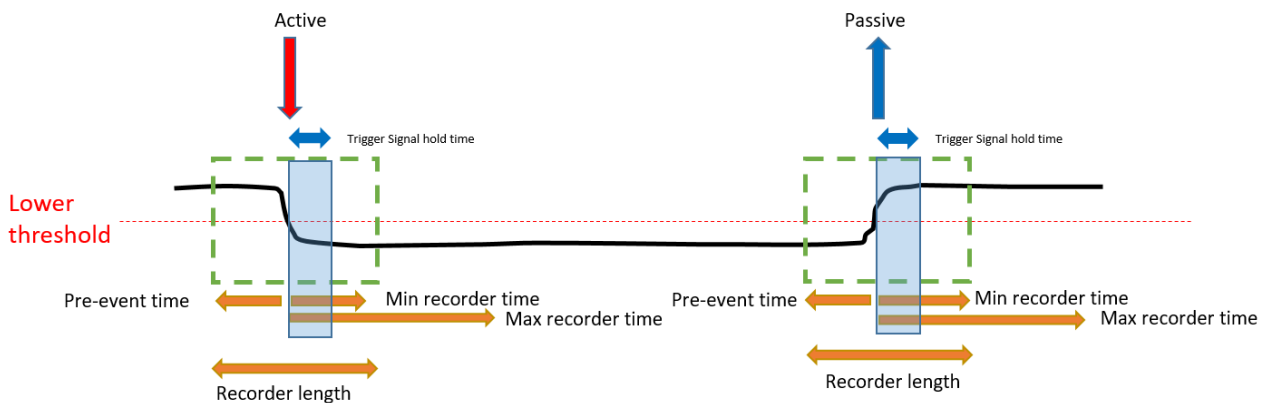

► **Example 2: Single fault with activated «active» and «passive» trigger & retrigger**

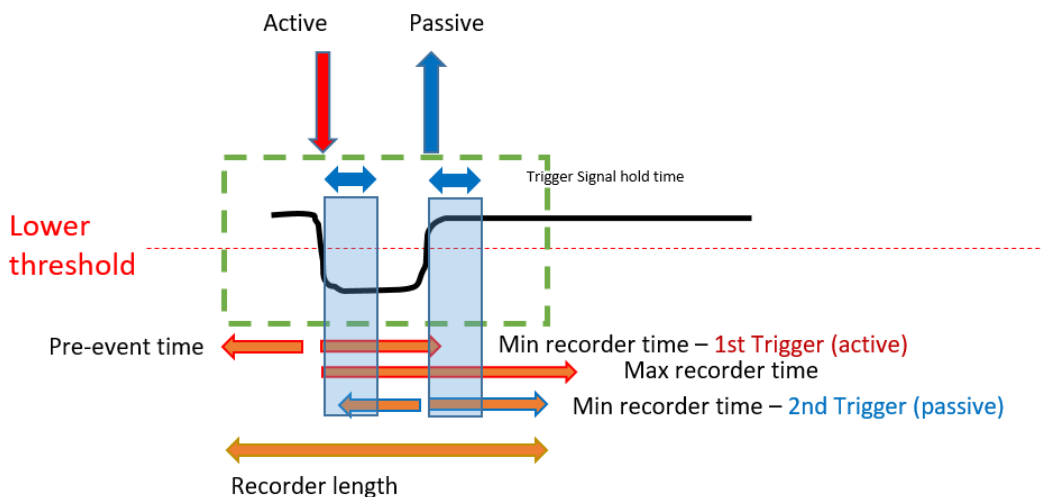

INFO: if another trigger criterion occurs during the minimum recording length after the trigger signal hold-time, the Record is extended by the minimum length up to the maximum length

► **Example 3: double fault with activated «active» and «passive» trigger, retrigger combined with trigger signal hold time & max time**

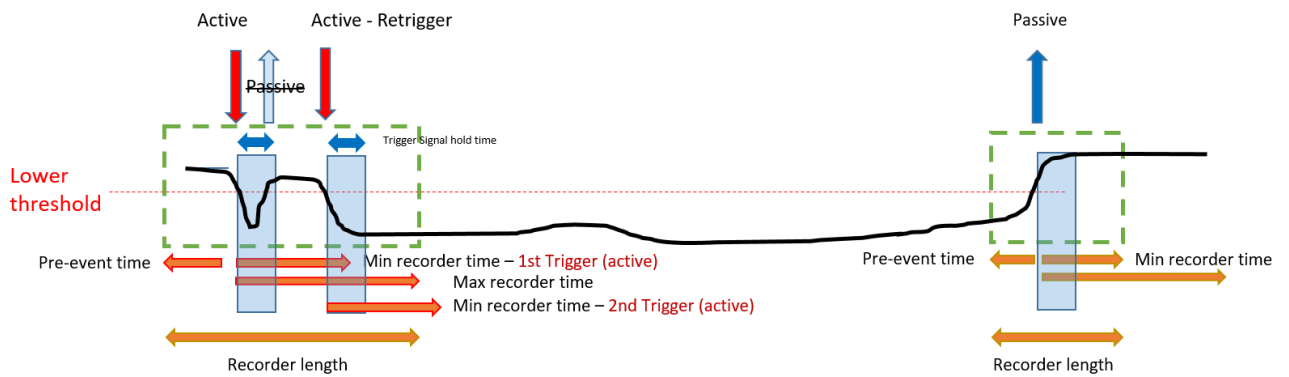

Info: Passive Trigger is not evaluated during “trigger signal hold time”, which can be set up inside Expert mode

## 7.4.6 RMS Recorder

In this menu, the trigger conditions of the RMS recorder can be set. In the default settings, an effective value threshold of +10% and -10% of the nominal voltage is set.

The screenshot shows the WinPQSmart 4.4.0 - 04.07.2018 software interface. The sidebar on the left contains navigation icons for Basic settings, Limits, Oscilloscope Recorder, 10ms RMS recorder (highlighted), Ripple control, and Time Settings. The main window displays the RMS Recorder settings menu, which is organized into several sections:

- Voltage / current trigger:** A table with columns for active/passive, Lower threshold [V], Upper threshold [V], Step [V], Phase Step [°], and Envelope Trigger[%]. Rows include UL1, UL2, UL3, UNE, U12, U23, U31, I1, I2, I3, and I4.
- Symmetrical Components Trigger:** A section with checkboxes for active/passive and input fields for Undervoltage positive sequence component, Overvoltage positive sequence component, Overvoltage negative sequence component, and Zero sequence system.
- Frequency Trigger:** A section with checkboxes for active/passive and input fields for Frequency: Lower Limit [Hz], Frequency: Upper limit [Hz], and Frequency Step.
- Binary Trigger:** A section with checkboxes for Binary input falling edge 1, Binary input falling edge 2, Binary Input Rising Edge 1, Binary Input Rising Edge 2, and a Trigger Command checkbox.
- Recorder length / Pre-event time:** A section with input fields for pre-event time [s], minimum recorder time [s], and maximum recorder time [s].

The interface also includes a sidebar on the right with buttons for Send, Open Templates, Open custom templates, Save, factory settings, and a Close button at the bottom right.

The settings in this menu are similar to the settings of oscilloscope recorder (see previous section) and are therefore not explained here again. If a field is greyed out and/or not selected, this trigger criterion is not active or cannot be activated.



The trigger thresholds of the oscilloscope and RMS recorder are not completely independent. All common parameters are automatically adjusted in both recorders.

## 7.4.7 Ripple Control

In this menu, the parameters frequency ripple signal voltage [Hz] and threshold 3 sec ripple signal voltage [% of UC] can be set.

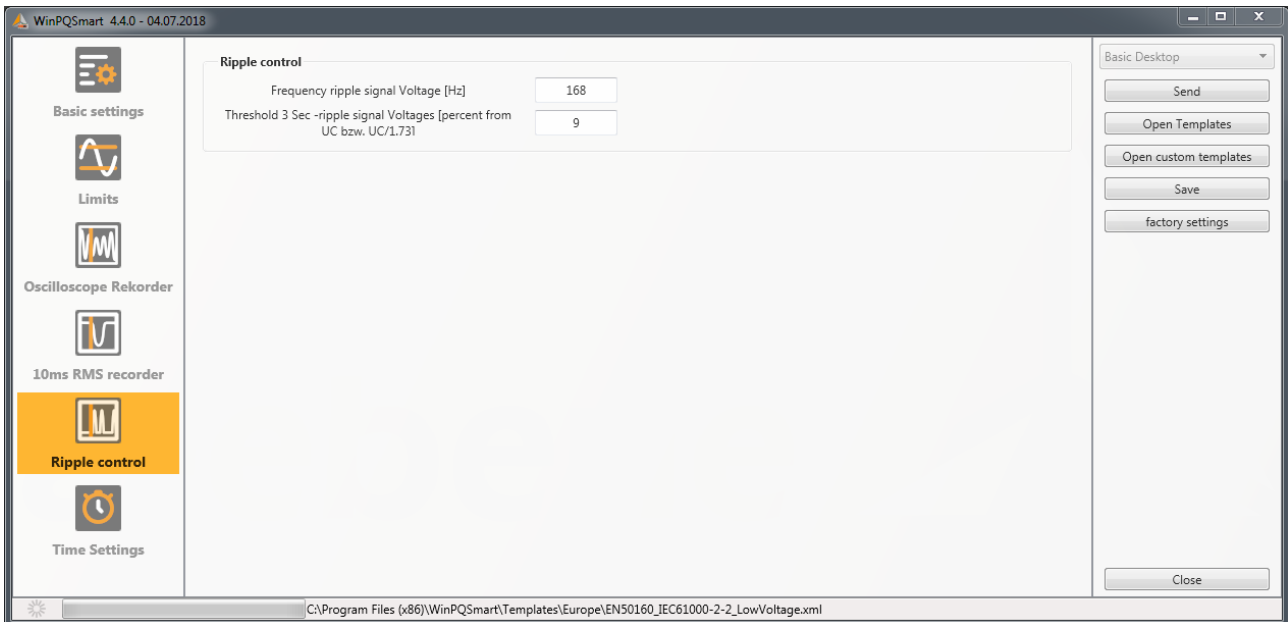

## 7.4.8 Time settings

In this window, the time settings of the device are parameterized. In the upper area, the time zone and the daylight saving time (DST) can be set.

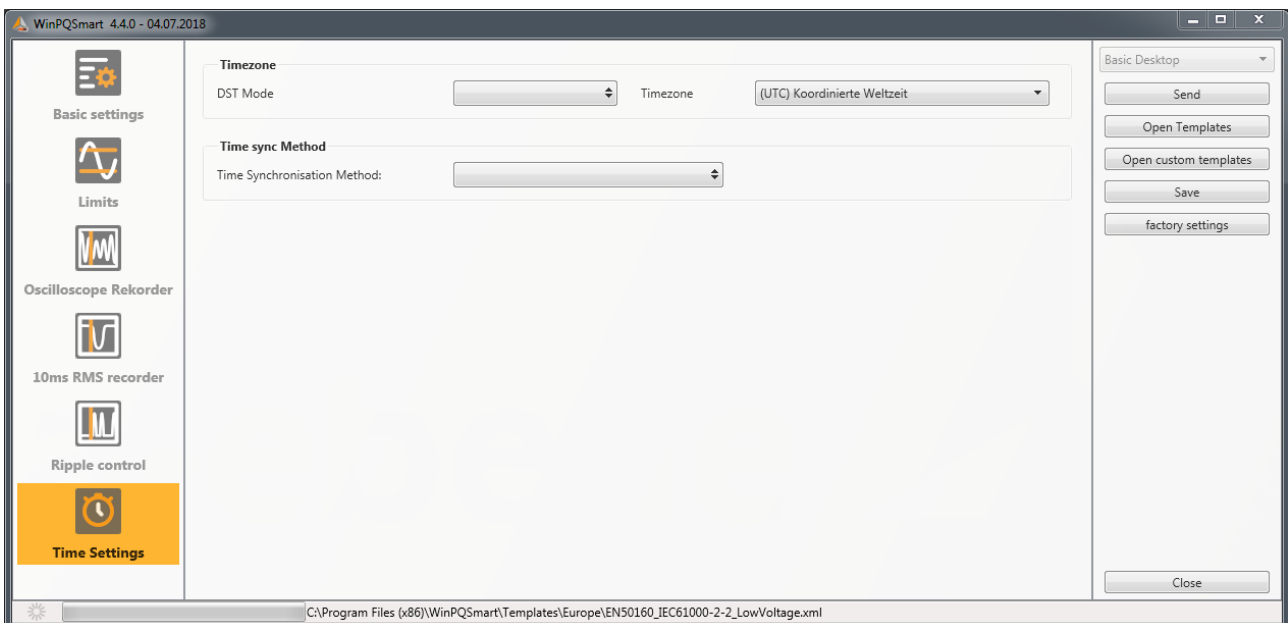

Below, the method of time synchronization can be selected.

For high-precision measurements, an independent clock such as GPS/DCF or NTP is recommended. (IEC61000-4-30: Class A - Measuring method!)

We take care of it.

---

Depending on the selection, the corresponding settings are displayed. The necessary setup steps, e.g. connection of a GPS clock etc. are described in detail in chapter 5.3.2.

The following time sync methods can be selected:

### 7.4.8.1 Manual Clock Setting

Manual synchronization of time and date with the local time of the computer. After synchronization, the function is locked for the current session. The parameterization interface must be restarted for a new execution. The local time of the encoder is not updated online, but only after the parameterization has been reloaded.

The screenshot shows the 'Time sync Method' configuration window. The 'Time Synchronisation Method' is set to 'Manual Clock setting'. Below this, the 'Time Settings by Hand' section contains four input fields: 'Date PC' (11.07.2018), 'Date Device' (01.04.2018), 'Local Time PC' (08:53:25), and 'Local Time Device' (01:42:20). A 'Time Synchronisation' button is located at the bottom of the settings area.

### 7.4.8.2 DCF77

Settings for synchronization with DCF 77 radio clock Art. No. 111.9024.01.

The screenshot shows the 'Time sync Method' configuration window with 'DCF77' selected. The 'Time settings DCF 77 with article 111.9024.01' section includes: 'Pulse-code Interface (COM2)' set to 'COM2', 'Protocol' set to 'RS232', 'Timezone of time source: sign' set to 'plus', and 'Timezone of time source: hour' and 'minute' both set to '0'. To the right, a wiring diagram shows connections between COM1 and COM2 pins (1-8) and labels: Tx/D, RTS, GND, RxD, CTS, RS485 Neg/B, RS485 Pos/A, and Shield.

### 7.4.8.3 IEEE1344

Settings for synchronization according to IEEE1344.

The screenshot shows the 'Time Settings IEEE 1344' configuration window. The settings are identical to the DCF77 configuration: 'Pulse-code Interface (COM2)' is 'COM2', 'Protocol' is 'RS232', 'Timezone of time source: sign' is 'plus', and 'Timezone of time source: hour' and 'minute' are '0'. The same wiring diagram for COM1 and COM2 is shown on the right.



### 7.4.8.4 IRIGB0..3

Settings for synchronization according to IRIGB formats 0 to 3.

**Time sync Method**

Time Synchronisation Method:

---

Time settings IRIG-B Formats 0 to 3

Pulse-code Interface (COM2)

Protocol

Timezone of time source: sign

Timezone of time source: hour

Timezone of time source: minute

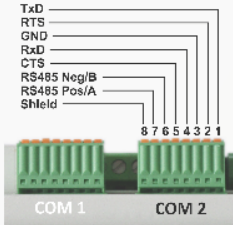

### 7.4.8.5 IRIGB4..7

Settings for synchronization according to IRIGB formats 4 to 7, see IRIGB formats 0 to 3.

### 7.4.8.6 NMEA:RMC (GPS-Clock 111.7083)

Settings for synchronization according to GPS-Clock 111.7083 with NMEA protocol a message format RMC.

**Time sync Method**

Time Synchronisation Method:

---

Time Settings NMEA RMC with GPS Clock 111.7083

Connection via COM1 and COM2 via RS485, Modbus RTU is not available in this mode.

NMEA Interface (COM1)

Pulse-code Interface (COM2)

### 7.4.8.7 NMEA:ZDA

Settings for synchronization with NMEA protocol and message format ZDA.

### 7.4.8.8 NTP

The PQI-DA *smart* supports up to four time servers in one network. It automatically uses the best signal available.

Time Settings NTP

NTP Sever 1: IP address	<input type="text" value="0.0.0.0"/>	Port:	<input type="text" value="123"/>
NTP Sever 2: IP address	<input type="text" value="0.0.0.0"/>	Port:	<input type="text" value="123"/>
NTP Sever 3: IP address	<input type="text" value="0.0.0.0"/>	Port:	<input type="text" value="123"/>
NTP Sever 4: IP address	<input type="text" value="0.0.0.0"/>	Port:	<input type="text" value="123"/>
NTP Pollycycle [s]	<input type="text" value="60"/>		

Incorrect time settings can lead to errors or problems during measurement data recording! Using NTP, a good signal quality should be assured (at least Stratum 7)!



The availability of the NTP server, the stratum and the quality of both NTP and the other time synchronization methods can be checked with the help of online diagnostics!

## 7.5 Device setup Expert View

For access to the advanced settings of the device, such as the parameterization of data recording or SCADA protocols, the "Expert View" provides a tabular representation of the device settings.

### 7.5.1 Device designations

The description of the device is defined in the "Device names" menu.

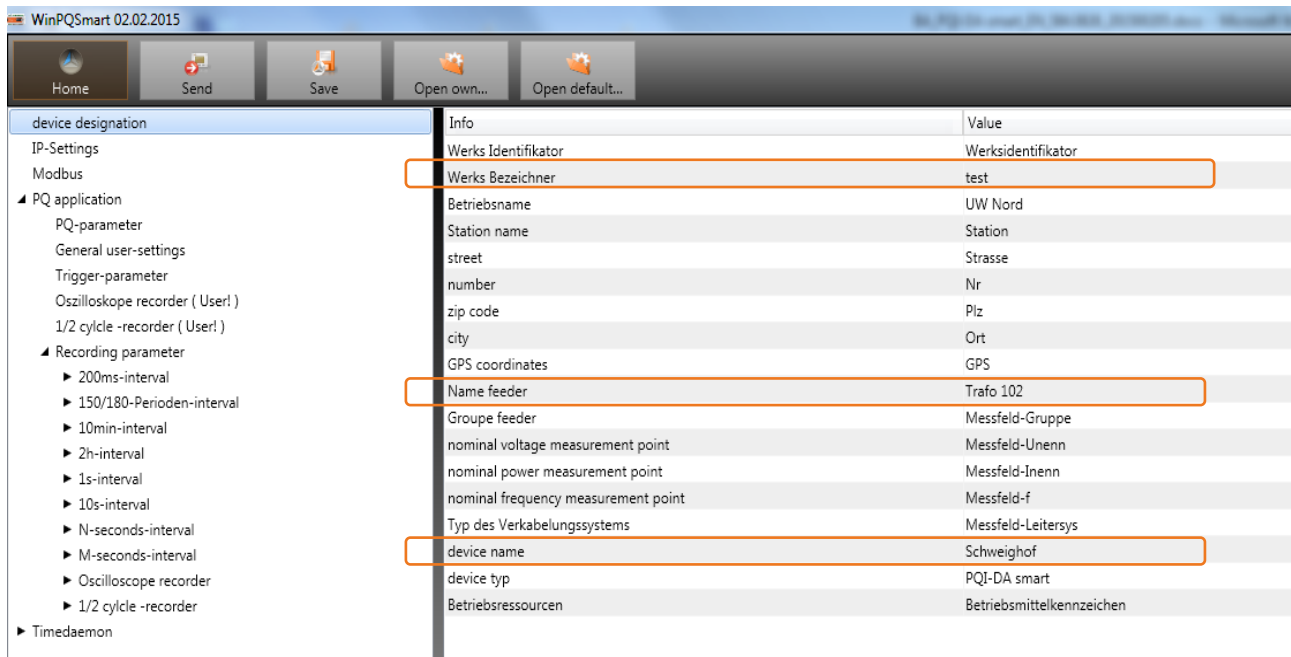

Info	Value
Werks Identifikator	Werksidentifikator
Werks Bezeichner	test
Betriebsname	UW Nord
Station name	Station
street	Strasse
number	Nr
zip code	Plz
city	Ort
GPS coordinates	GPS
Name feeder	Trafo 102
Groupe feeder	Messfeld-Gruppe
nominal voltage measurement point	Messfeld-Unenn
nominal power measurement point	Messfeld-Inenn
nominal frequency measurement point	Messfeld-f
Typ des Verkabelungsystems	Messfeld-Leitersys
device name	Schweighof
device typ	PQI-DA smart
Betriebsressourcen	Betriebsmittelkennzeichen

The orange marked fields describe the device tile as well as all fault records and measurement data in the archive.

We take care of it.

---

## 7.5.2 Thresholds and Recording

The menu tree "Thresholds and Recording" contains all parameters for Power Quality as well as all recording parameters.

The screenshot shows the WinPQSmart 4.2 - 10.06.2016 interface. The top navigation bar includes Home, Send, Save, Open, and Export (CSV). The main menu tree on the left is expanded to show 'Thresholds / Recording' and 'Recording parameter'. Two callout boxes with orange borders and arrows point to specific items in the menu tree:

- The first callout box points to the 'Thresholds / Recording' section, which includes: norm threshold values, Connection Settings, recorder trigger thresholds, oscilloscope recorder trigger length, 10ms TRMS recorder, Triggermessage binary output, and Binary Recording Control. The callout text reads: "Limit values Power Quality, Trigger settings for sequence of events recordings".
- The second callout box points to the 'Recording parameter' section, which includes: 200ms-interval, 150/180-Period-interval, 10min-interval, 2h-interval, 1s-interval, 10s-interval, N-seconds-interval, N-minutes-interval, Oscilloscope recorder, and 1/2 cycle-recorder. The callout text reads: "Selecting the measurement values within the interval classes".

### 7.5.2.1 Norm thresholds

In “norm thresholds” the limits for standard evaluations and for power quality events are set. The limits of EN 50160 for a low voltage system are stored in the default setting of delivery.

- Value: Value of PQI-DA *smart* – this value can be changed
- Default: Default setting

device designation	Frequency	50Hz	▼ 50Hz
IP-Settings	Frequency ripple signal voltage [Hz]	168	168
▶ License Manager	Flicker bulb	230V	▼ 230V
Modbus	Normalized voltage L-L-Sp. [percent from UNOM]	100	100
▲ Thresholds / Recording	hysteresis 1/2-Perioden-voltage [percent from UC bzw. UC/1...	1	1
norm threshold values	tolerance band fast voltage change RVC, dd [percent from U...	1	1
Connection Settings	threshold voltage dip (Dip) [percent from UC bzw. UC/1.73]	90	90
recorder trigger thresholds	threshold voltage swell (threshold) [percent from UC bzw. UC...	110	110
oscilloscope recorder trigger length	threshold voltages interruption [percent from UC bzw. UC/1.7...	5	5
10ms TRMS recorder	lower threshold 10s- network frequency /Hz	49,5	49,5
Triggermessage binary output	higher threshold 10s-Total network frequency /Hz	50,5	50,5
Binary Recording Control	lower threshold 10min-voltage [percent from UC bzw. UC/1.73]	90	90
▲ Recording parameter	higher threshold 10min- voltage [percent from UC bzw. UC/1...	110	110
▶ 200ms-interval	threshold 10min-THD [percent]	8	8
▶ 150/180-Period-interval	threshold 10min-voltages unbalance [percent]	2	2
▶ 10min-interval	threshold short time flicker PST	1	1
▶ 2h-interval	threshold long time flicker PLT	1	1
▶ 1s-interval	threshold 3 Sec -ripple signal voltages [percent from UC bzw....	9	9
▶ 10s-interval	Trigger-threshold 200ms-ripple signal voltage recorder [perc...	1	1
▶ N-seconds-interval	○ limit table 10min-voltages harmonic (H2) [percent]	2	2
▶ N-minutes-interval	threshold 10min-voltages harmonic (H3) [percent]	5	5
▶ Oscilloscope recorder	threshold 10min-voltages harmonic (H4) [percent]	1	1
▶ 1/2 cycle -recorder	threshold 10min-voltages harmonic (H5) [percent]	6	6
▶ Binary Recording	threshold 10min-voltages harmonic (H6) [percent]	0,5	0,5
Syslog			
▶ IEC 60870-5-104			
▶ Timedaemon			

### 7.5.2.2 Connection settings

device designation	connection configuration voltage inputs	VT L1, L2, L3, N	▼ VT L1, L2, L3, N
IP-Settings	reference voltage input Frequency measurement	U1N	▼ U1N
▶ License Manager	Power calculation	without Unbalance Reactive Power	▼ without Unbalance Reactive Power
Modbus	connection configuration current inputs	CT L1, L2, L3, N	▼ CT L1, L2, L3, N
▲ Thresholds / Recording	Network type	4 - wire system ( three phase grid)	▼ 4 - wire system ( three phase grid)
norm threshold values	interval n-seconds-data class [s], 2..60	60	60
Connection Settings	binary input for trigger interval-Power	internal interval	▼ internal interval
recorder trigger thresholds	interval N-Minute-data class [min] , 1..60	15	15
oscilloscope recorder trigger length	THD and THC calculation	H40	▼ H40
10ms TRMS recorder	voltage transducer factor (VT)	1	1
Triggermessage binary output	current transducer factor (CT)	1	1
Binary Recording Control	Transducer correction factor U1	1	1
▲ Recording parameter	Transducer correction factor U2	1	1
▶ 200ms-interval	Transducer correction factor U3	1	1
▶ 150/180-Period-interval	Transducer correction factor U4	1	1
▶ 10min-interval	CT correction factor I1	1	1
▶ 2h-interval	CT correction factor I2	1	1
▶ 1s-interval	CT correction factor I3	1	1
▶ 10s-interval	CT correction factor I4	1	1
▶ N-seconds-interval			
▶ N-minutes-interval			
▶ Oscilloscope recorder			

The following basic instrument settings can be made in this menu item:

We take care of it.

---

▶ **Connection voltage inputs: 1, 2, 3, 4**

- VT L1, L2, L3, N
- V-circuit, grounding L1
- V-circuit, grounding L2
- V-circuit, grounding L3

V-connection (two voltage transformers)  
Grounding L2 = connect VT L1 and VT L3  
L2 will be calculated from the device

Reference voltage:

Determining the frequency measurement input channel: U1, U2, U3, Une, U12, U23, U31

▶ **Power calculation:**

- Simplified power calculation - without calculation of unbalance power
- According DIN40110-2; with calculation of the unbalance reactive power

This setting has also an effect on the power values in the display of the PQI-*smart*

▶ **Connection current inputs:**

- CT L1, L2, L3, N
- CT L2,L3
- ct's L1, L3
- ct's L1, L2

Aron connection of current (two CT's)  
CT L1, L3 = connect L1 and L3, current L2 will be calculated from the device

▶ **Network connection:**

- 4 - wire system ( three phase grid)
- 4 - wire system (unique independent phases )
- 3 - wire system

▶ **Interval "n"-seconds data class:**

Free interval - 2 seconds to 60 seconds

▶ **Binary input for power intervals:**

- internal interval
- synchronised Power values at Binary Input 1
- synchronised Power values at Binary Input 2

All power and energy intervals are synchronized to this impulse

▶ **Interval "n"-minutes data class:**

Free interval - 1 minute to 60 minutes (basic setting 15 minutes)

▶ **Calculation THD / THC:**

Calculation 2<sup>nd</sup> to 40<sup>th</sup> harmonic or 2<sup>nd</sup> to 50<sup>th</sup> harmonic

▶ **Voltage transducer factor (basic setting = 1)**

Example: VT 20.000V / 100V = factor 200

▶ **Current transducer factor (basic setting = 1)**

Example: CT 600V / 5A = factor 120

▶ **CT correction factor**

Additional to the current transducer factor it is possible to have a second CT correction factor. This factor will be multiplied with the current transducer factor. Possible values are from 2 to 2.



Using a current transformer correction factor of "-1", it is possible to change the power flow direction by software.

### 7.5.2.3 Trigger parameter for disturbance recorder

In this menu all limits for triggering of fault records can be changed. These thresholds are independent to the Power Quality thresholds.

Upper and lower trigger thresholds for frequency, voltage, current or unbalance can be set.

device designation	trigger signal-hold time [s]	1	1
IP-Settings	Frequency-hysteresis [Hz]	0,05	0,05
▶ License Manager	Frequency : upper limit [Hz]	50,5	50,5
Modbus	Frequency : lower limit [Hz]	49,5	49,5
▲ Thresholds / Recording	Frequency : threshold df 1/2 [Hz/s]	0,5	0,5
norm threshold values	voltages-hysteresis [percent from UC bzw. UC/1.73]	2	2
Connection Settings	Star voltage: upper limit [percent from UC/1.73]	110	110
recorder trigger thresholds	Star voltage: lower limit [percent from UC/1.73]	90	90
oscilloscope recorder trigger length	Star voltage: threshold dU 1/2 [percent from UC/1.73]	10	10
10ms TRMS recorder	Star voltage: threshold dphi 1/2 /Grad	6	6
Triggermessage binary output	Displacement voltage: upper limit [percent from UC/1.73]	30	30
Binary Recording Control	Displacement voltage: threshold dU 1/2 [percent from UC/1.73]	10	10
▲ Recording parameter	line-to-line voltage: upper limit [percent from UC]	110	110
▶ 200ms-interval	line-to-line voltage: lower limit [percent from UC]	90	90
▶ 150/180-Period-interval	line-to-line voltage: threshold dU 1/2 [percent from UC]	10	10
▶ 10min-interval	Star voltage: threshold envelopentrigger [percent from UC/1....	20	20
▶ 2h-interval	line-to-line voltage: threshold envelopentrigger [percent fro...	20	20
▶ 1s-interval	Displacement voltage: threshold envelopentrigger [percent fr...	20	20
▶ 10s-interval	positive sequence voltage: upper limit [percent from UC/1.73]	110	110
▶ N-seconds-interval	positive sequence voltage: lower limit [percent from UC/1.73]	90	90
▶ N-minutes-interval			
▶ Oscilloscope recorder			
▶ 1/2 cycle -recorder			

#### Example:

line-to-line voltage: lower limit [percent from UC]	90
line-to-line voltage: threshold dU 1/2 [percent from UC]	10

If one phase to phase voltage exceeds 110% or 90% of the nominal voltage, the oscilloscope and the ½ period RMS recorder will start recording.



### 7.5.2.4 Oscilloscope recorder

The oscilloscope disturbance recorder is set up under the menu item "Limits/Recording -> Oscilloscope Recorder".

device designation	minimum recorder length (Nr. of items)	4096	4096
IP-Settings	maximum recorder length (Nr. of items)	10240	10240
▶ License Manager	Rekorder pretime (Nr. of items)	1024	1024
Modbus	lower voltage U1E -> aktive	1	1
▲ Thresholds / Recording	lower voltage U2E -> aktive	1	1
norm threshold values	lower voltage U3E -> aktive	1	1
Connection Settings	lower voltage U12 -> aktive	1	1
recorder trigger thresholds	lower voltage U23 -> aktive	1	1
oscilloscope recorder trigger length	lower voltage U31 -> aktive	1	1
10ms TRMS recorder	lower voltage U1E -> passive	0	0
Triggermessage binary output	lower voltage U2E -> passive	0	0
Binary Recording Control	lower voltage U3E -> passive	0	0
▲ Recording parameter	lower voltage U12 -> passive	0	0
▶ 200ms-interval	lower voltage U23 -> passive	0	0
▶ 150/180-Period-interval	lower voltage U31 -> passive	0	0
▶ 10min-interval	over voltage U1E -> aktive	1	1
▶ 2h-interval	over voltage U2E -> aktive	1	1
▶ 1s-interval	over voltage U3E -> aktive	1	1
▶ 10s-interval	over voltage U12 -> aktive	1	1
▶ N-seconds-interval	over voltage U23 -> aktive	1	1
▶ N-minutes-interval	over voltage U31 -> aktive	1	1
▶ Oscilloscope recorder	over voltage U1E -> aktive	1	1
▶ 1/2 cycle -recorder	over voltage U23 -> aktive	1	1

- **Minimum recorder length:** Setting of the standard fault recorder length
- **Maximum recorder length:** If one fault last longer than the minimum recorder length, the PQI-DA *smart* will enlarge the recorder length up to a maximum recorder length. The maximum recorder length of one recorder file can be set here.
- **Recorder pre time** is the time of the recorder file before the trigger threshold occurred.

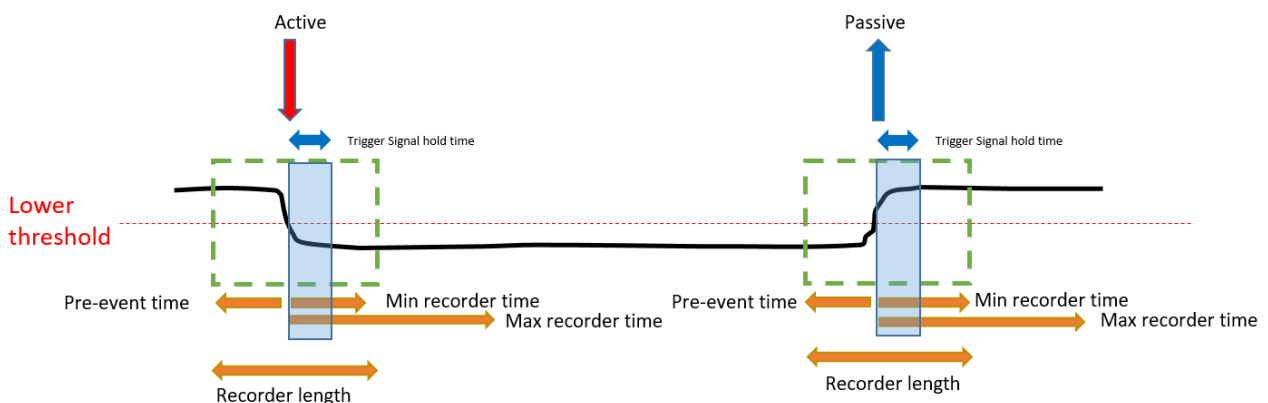

- Active trigger = value exceeds or falls below threshold (start of the event)
- Passive trigger = value comes back to normal (end of the event)

| Sampling frequency : 40960Hz / 10240Hz

10240

40960

10240

40960

- Sampling frequency of oscilloscope recorder can be changed from 10240 Hz to 40960 Hz

The maximum recorder length with 10,24kHz is 16 seconds as well as with 40,96kHz is 4 seconds

We take care of it.

(40960Hz is only available with option B1) **Example recorder length:** 20480 = 2 seconds recorder length with a sampling frequency of 10240Hz and 500ms length with a sampling frequency of 40960 Hz.

### 7.5.2.5 ½ cycle recorder

The trigger settings of ½ cycle recorder (10ms at 50Hz) are independent to oscilloscope recorder.

device designation	minimum recorder length (valuee)	1000	1000
IP-Settings	maximum recorder length (valuee)	30000	3000
▶ License Manager	Rekorder pretime (valuee)	250	250
Modbus	lower voltage U1E -> aktive	1	1
▲ Thresholds / Recording	lower voltage U2E -> aktive	1	1
norm threshold values	lower voltage U3E -> aktive	1	1
Connection Settings	lower voltage U12 -> aktive	1	1
recorder trigger tresholds	lower voltage U23 -> aktive	1	1
oscilloscope recorder trigger length	lower voltage U31 -> aktive	1	1
10ms TRMS recorder	lower voltage U1E -> passive	0	0
Triggermessage binary output	lower voltage U2E -> passive	0	0
Binary Recording Control	lower voltage U3E -> passive	0	0
▶ Recording parameter	lower voltage U12 -> passive	0	0
Binary Recording	lower voltage U23 -> passive	0	0
Syslog	lower voltage U31 -> passive	0	0
▶ IEC 60870-5-104	over voltage U1E -> aktive	1	1
▶ Timedaemon	over voltage U2E -> aktive	1	1
	over voltage U3E -> aktive	1	1
	over voltage U12 -> aktive	1	1

Please see Chapter 7.5.2.3 explanation trigger thresholds

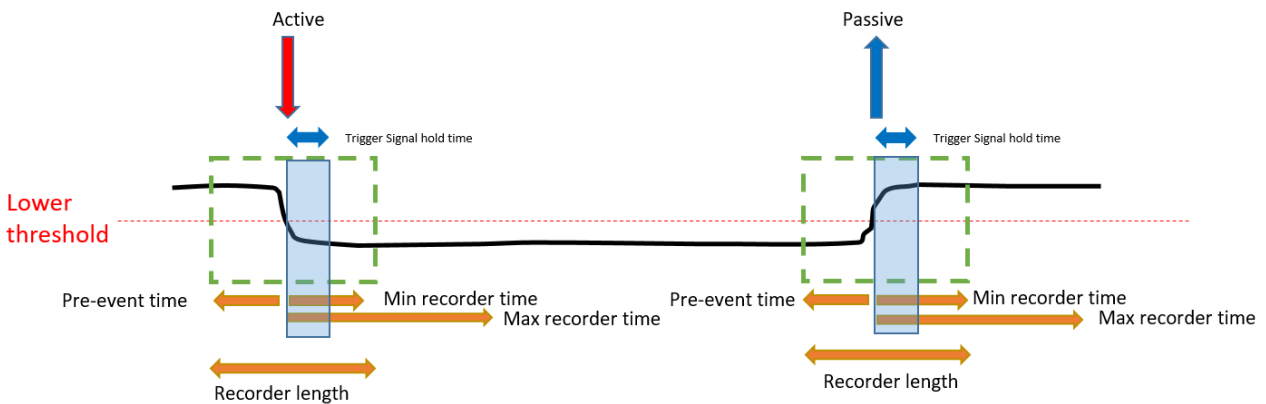

#### Example recorder length:

3000 x 10ms (at 50Hz) r.m.s values results in a length of 30 seconds for this recorder.

### 7.5.2.6 Trigger of binary output 2

It is possible to set all trigger events of the fault recorder on the relay no. 2. If one threshold is reached e.g. "frequency", the relays output will be switched very fast. The reaction time from the detection of the event to trigger the relay output is <10ms.

Threshold / Event	Value
lower voltage U12 -> aktive	1
lower voltage U23 -> aktive	1
lower voltage U31 -> aktive	1
lower voltage U1E -> passive	0
lower voltage U2E -> passive	0
lower voltage U3E -> passive	0
lower voltage U12 -> passive	0
lower voltage U23 -> passive	0
lower voltage U31 -> passive	0
over voltage U1E -> aktive	1
over voltage U2E -> aktive	1
over voltage U3E -> aktive	1
over voltage U12 -> aktive	1
over voltage U23 -> aktive	1
over voltage U31 -> aktive	1
over voltage UNE -> aktive	1
over voltage U1E -> passive	0
over voltage U2E -> passive	0
over voltage U3E -> passive	0
over voltage U12 -> passive	0
over voltage U23 -> passive	0
over voltage U31 -> passive	0
over voltage UNE -> passive	0
Trigger-command	1
lower voltage positive-sequence system -> aktive	0
over voltage positive-sequence system -> aktive	0

Possible triggering criteria:

- Lower / upper voltage
- Positive sequence / negative sequence
- Envelop voltage trigger
- Voltage step / current step
- Phase change
- Lower frequency / upper frequency
- Frequency change
- Lower current / upper current
- Binary input

All trigger events can be set to the start of the event or to the end of the event (active / passive trigger).

We take care of it.

---

### 7.5.2.7 Control of recording via binary inputs

With the input signal of the two digital inputs, it is possible to start and stop the PQI-DA *smart* recorders. The following functions can be started or stopped via the digital input:

- All permanent recorder
- Oscilloscope recorder
- ½-cycle RMS recorder



To control the recording of PQI-DA *smart* with the two binary inputs, two settings are available:

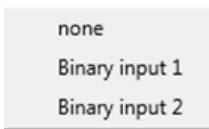

With the function "logic level recording control" the signal may be negated.

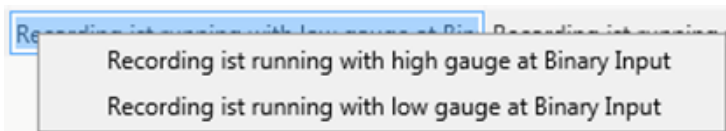

### 7.5.3 Recordings parameter

At this point, the selection of all permanent measured values within the interval data class is set.

The following interval data classes available

- 10/12 cycle (200ms interval)
- 150/180 cycle (3 seconds interval)
- 10 minutes interval
- 2 h interval
- 1 seconds interval
- 10 seconds interval
- N x seconds interval (range 2 to 60)
- N x minutes interval (range 1 to 60 – basic setting 15 min.)

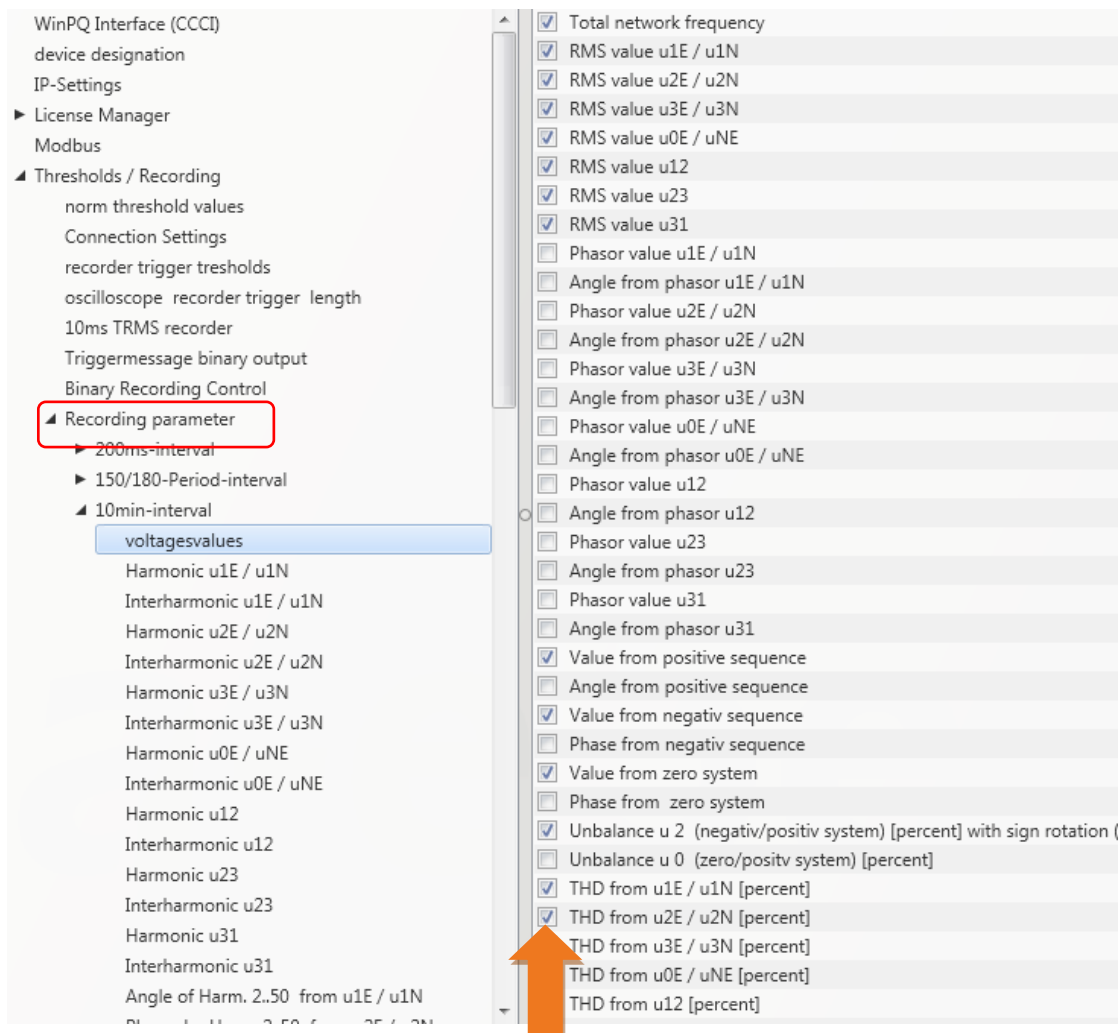

All activated measuring values are permanently recorded in this data class.

We take care of it.

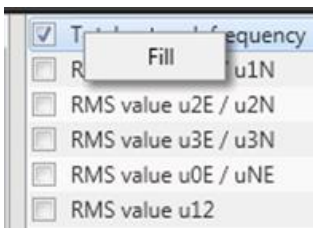

With right mouse click you can activate or deactivate all parameters in this list with the function "fill".

### 7.5.3.1 Disturbance recorder parameter

For oscilloscope recorder and 1/2 cycle recorder it is possible to activate and deactivate measurement values.

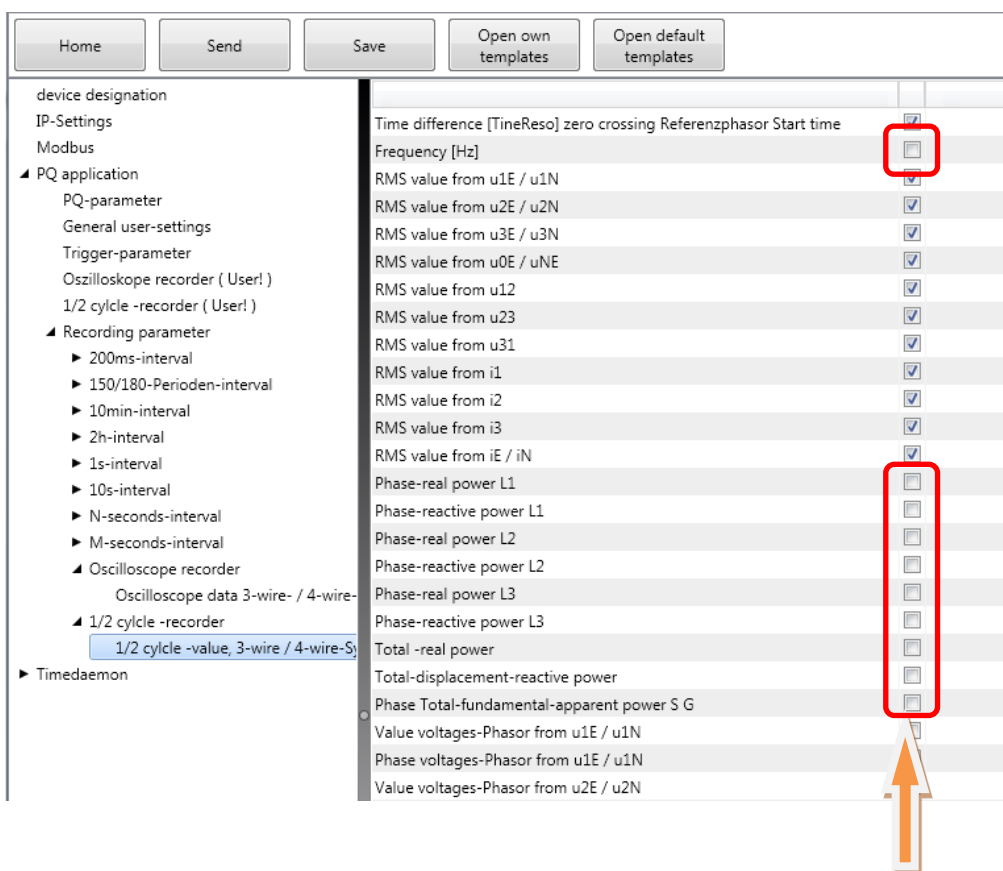

Example:

The 1/2 cycle recorder should also record the power and the frequency during a disturbance record.

## 7.6 Online measurement values



The "Online" function offers extensive analysis functions for online measurement values.

Start screen of the online measurement values:

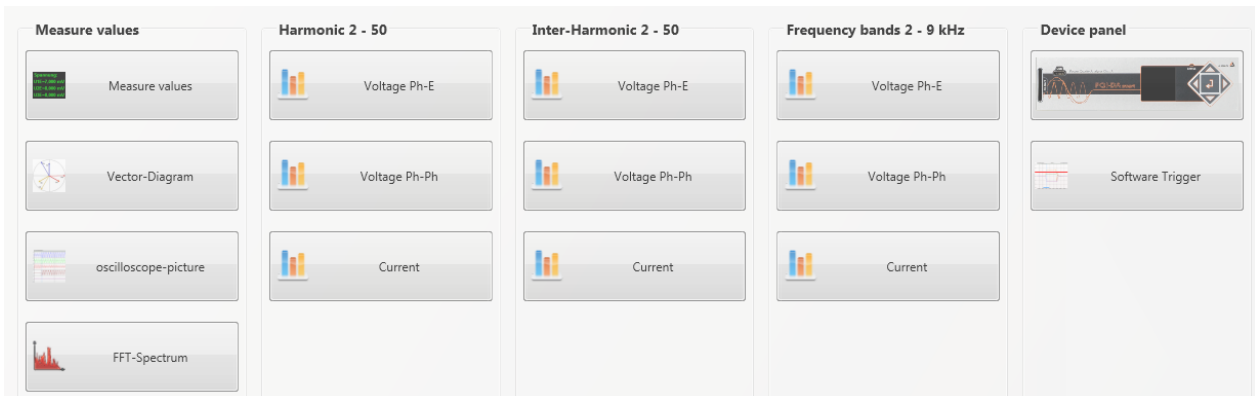

### 7.6.1 Measurement values

Display of online measurement values for voltages, currents, power and grid frequency.

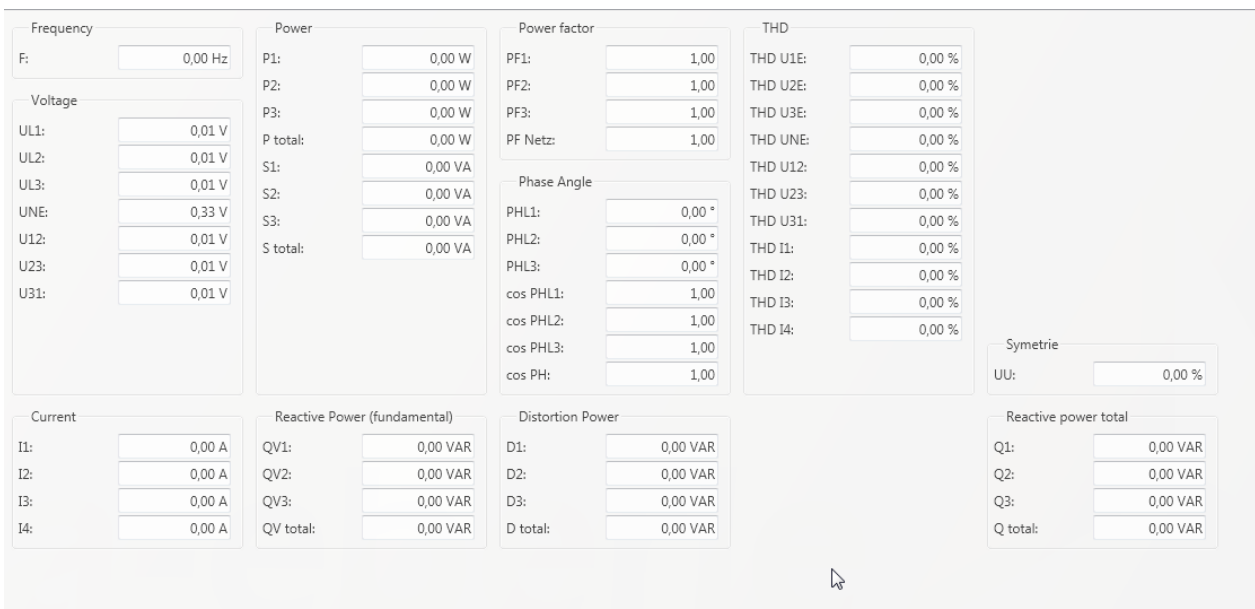

We take care of it.

## 7.6.2 Vector diagram

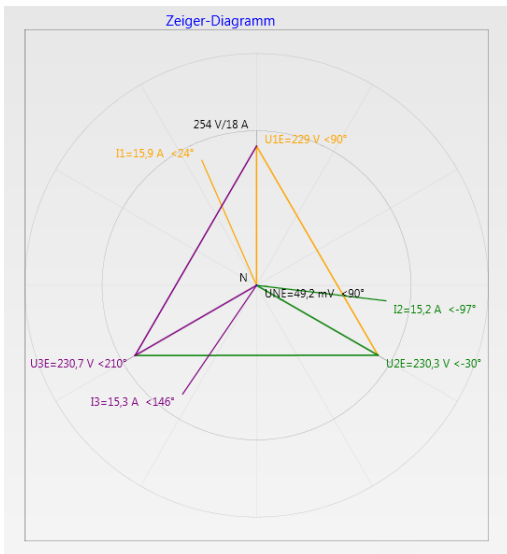

In the vector diagram, connection faults are easy to detect. All phase voltages and currents are displayed with phase angles.

## 7.6.3 Oscilloscope image

Online oscilloscope (40.96 kHz/ 10.24kHz) for the following channels:

- Conductor-earth voltages L1, L2, L3, NE
- Conductor-conductor voltages L12, L23, L31
- Currents L1, L2, L3, N

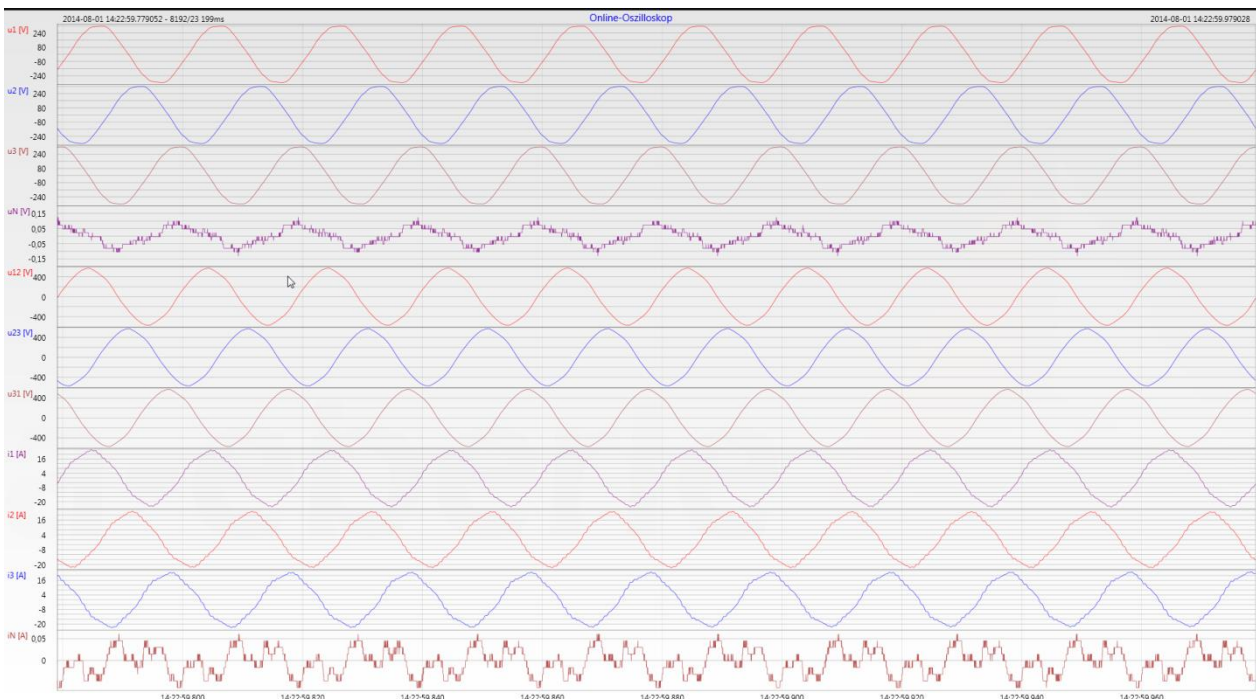



## 7.6.4 Online spectrum FFT-Analyse

Online-FFT analysis depending on the license of the device

- Sampling frequency 41,96kHz = FFT analysis up to 20kHz
- Sampling frequency 10,24kHz = FFT analysis up to 5kHz

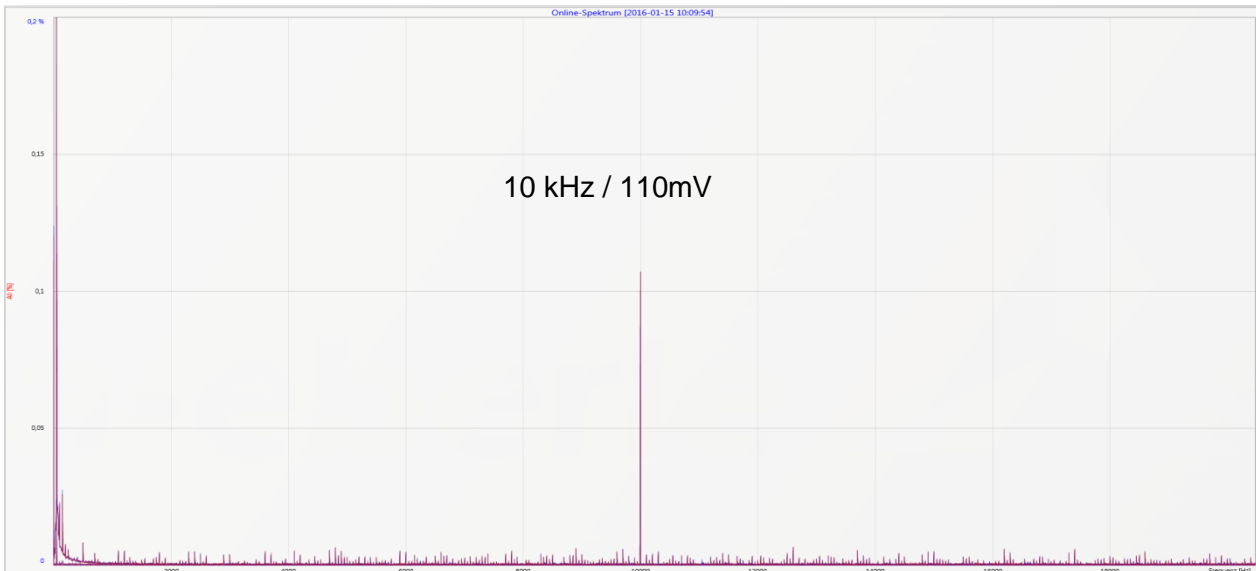

*Example: charging device for electrical cars / 10 kHz sampling frequency visible in the FFT analysis.*

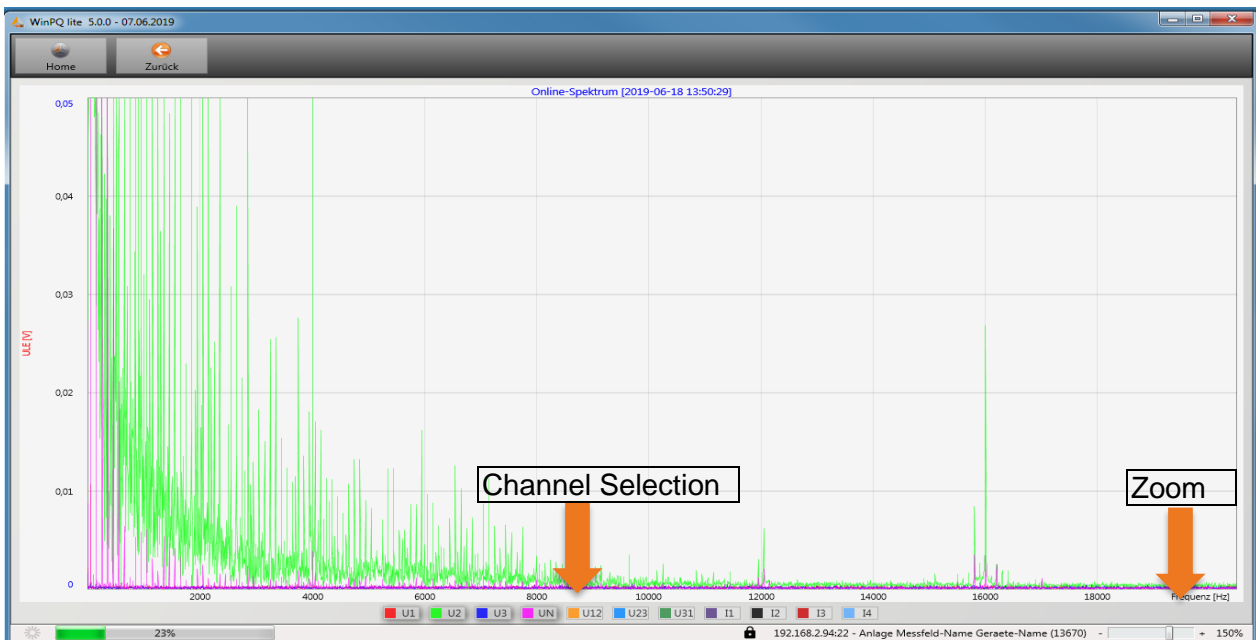

Using the zoom function it is possible to adjust the scaling of the application.

Using the buttons U1 / U2 ...I4 it is possible to fade in and fade out channels every second during refresh.

## 7.6.5 Harmonic

From the "Harmonics" tab page, all of the current and voltage harmonics (2nd to 50th) can be displayed online. The measurement data is calculated by the measuring device in accordance with IEC61000-4-30 Class A Ed. 3 and transferred to the PC.

There are three bar charts available:

- Voltage harmonics conductor-earth
- Voltage harmonics conductor-conductor
- Current harmonics

As the EN50160 only specifies limits for harmonics up to the 25th ordinal, the compatibility level of IEC61000-2-2 has been stored for the 26th to the 50th harmonics in the basic settings.

Compatibility levels in accordance with EN50160 & IEC61000-2-2 are shown as green limit value bars.

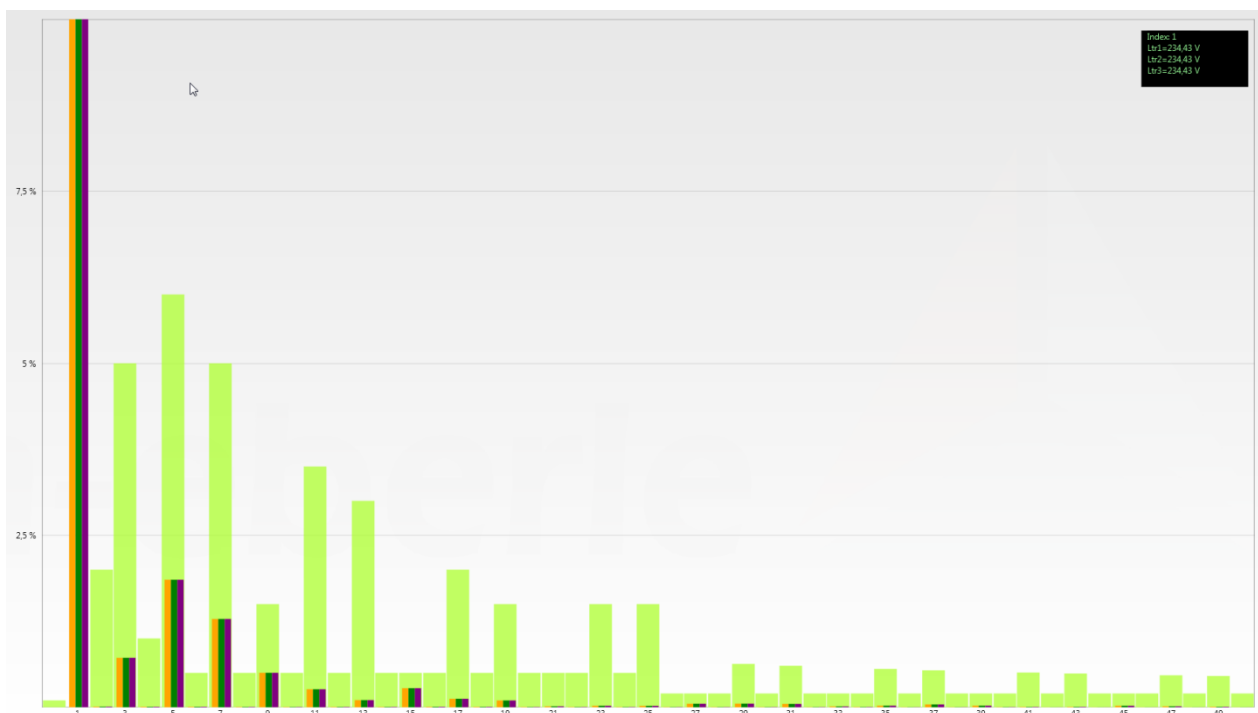

If a harmonic is selected with the mouse pointer, this measurement value is displayed in the field on the top right.

### 7.6.6 Interharmonic

The "Interharmonic" card is used to display all current and voltage Interharmonic up to 2,500 Hz online. The measurement data is calculated by the measuring device in accordance with IEC61000-4-30 Class A following the grouping process and transferred to the PC.

There are three bar charts available:

- Interharmonic voltages line-earth
- Interharmonic voltages line-earth
- Interharmonic currents

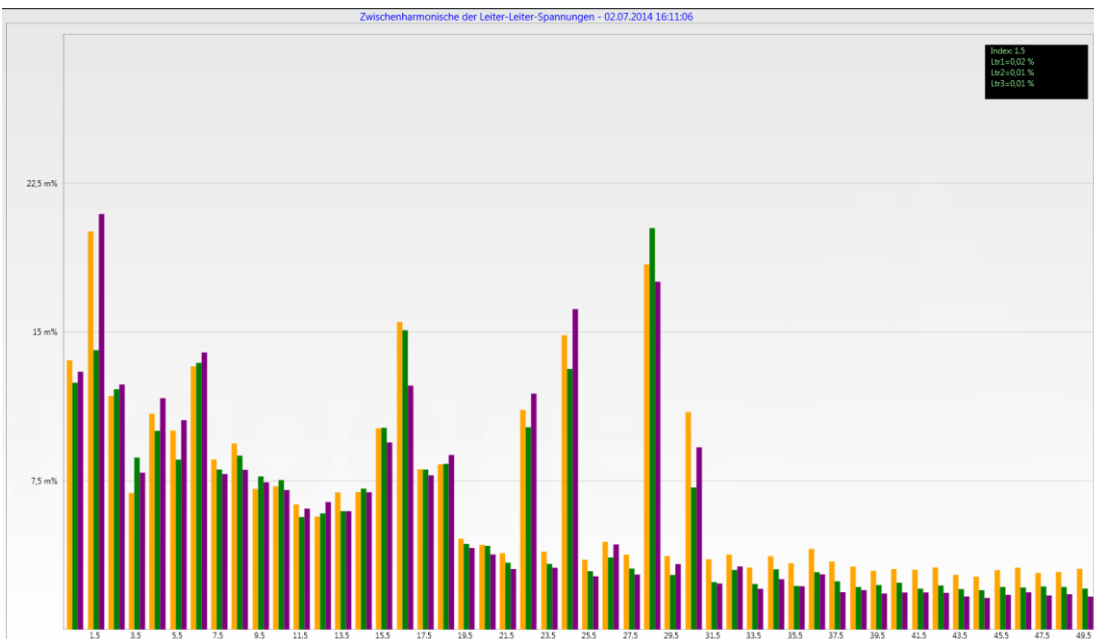

If an Interharmonic is selected with the mouse pointer, this measurement value is displayed in the field on the top right.

► **Explanation of the grouping process in accordance with the IEC:**

To evaluate the Interharmonic in the grid, subgroups are created. In each case, all of the Interharmonics between two harmonics are combined into one harmonics subgroup.

Example for 50Hz: Interharmonic H2 includes all frequencies from 110Hz to 140Hz.

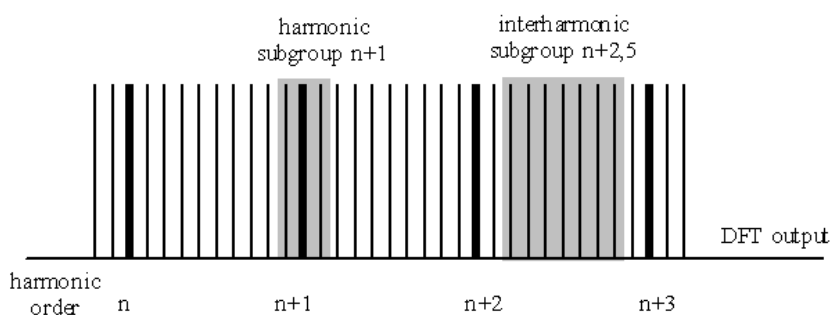

## 7.6.7 Frequency bands from 2kHz to 9kHz

- ▶ The device characteristic "Frequency bands from 2kHz to 9kHz" is a device option

The card "2 to 9kHz" is used to display all current and voltage harmonics in 200Hz groups. Evaluation is in accordance with the IEC61000-4-7 standard.

The centre frequency of the corresponding frequency band is stated.

Example: All frequencies from 8,805Hz to 9,000 Hz are located in the 8.9 kHz band.

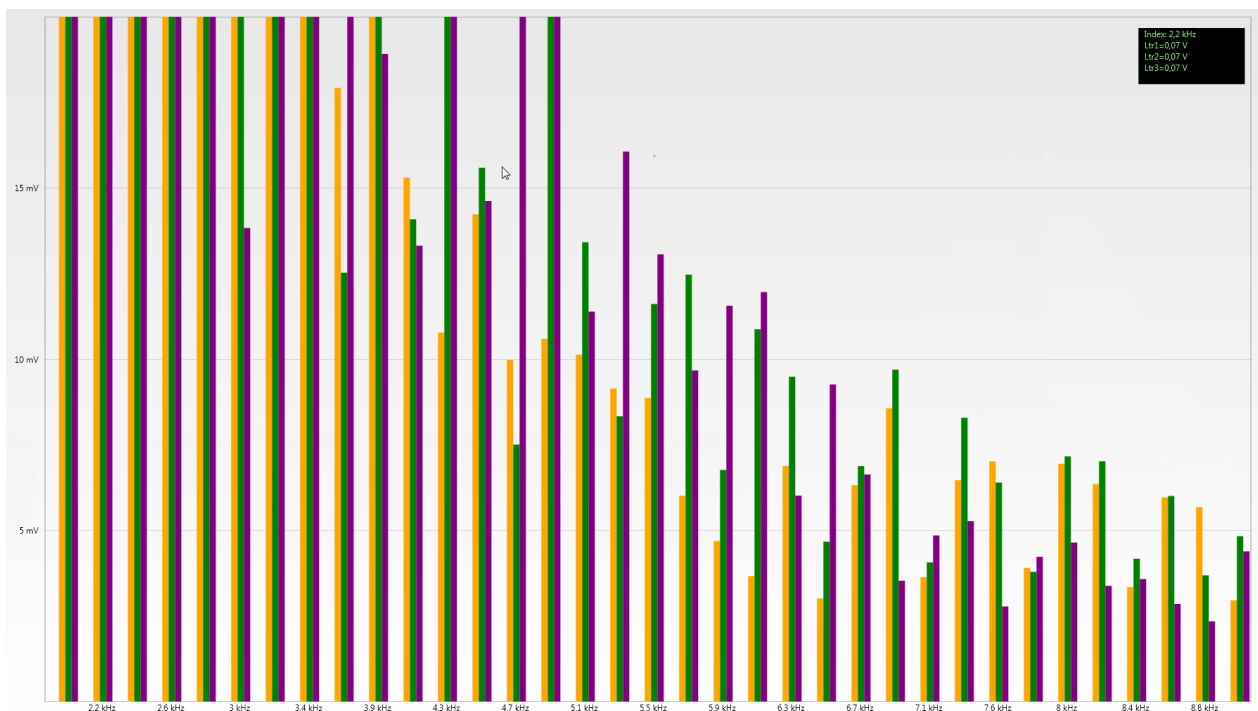

If a frequency band is selected with the mouse pointer, this measurement value is displayed in the field on the top right.

### 7.6.8 Device panel

The device panel can be used for the remote control of the device via the 5-key keypad.

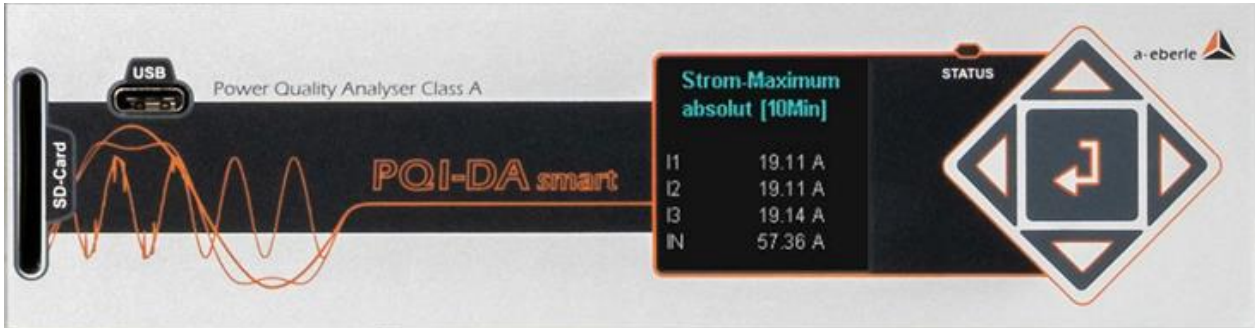

- Scrolling the measurement value displays (right – left keys)

The left and right keys can be used to scroll the measurement value screens.

- Setup settings

The Enter key  is used to open the setup menu of the device.



### 7.6.9 Software trigger

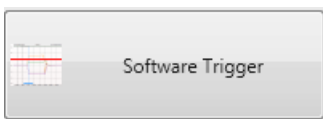

The "Software Trigger" key can be used to trigger the oscilloscope recorder and ½-period RMS recorder manually. The recorder length corresponds with the settings in the setup menu of the device.

## 7.7 Measurement data import



The "Import" function can be used to load all measurement data from the PQI-DA *smart* to the PC and to evaluate it there.

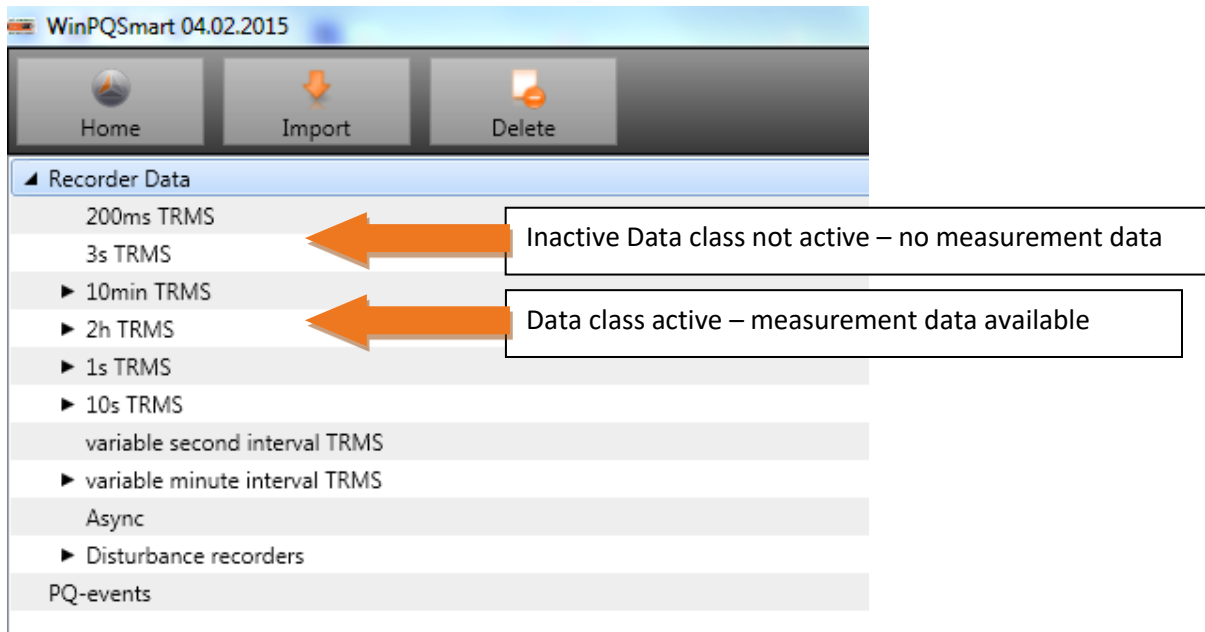

Import of data can be selected to:

- Only selected data files from the device
- All events
- Selected events

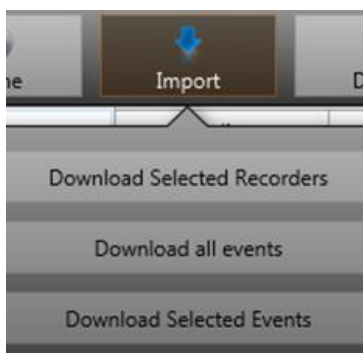

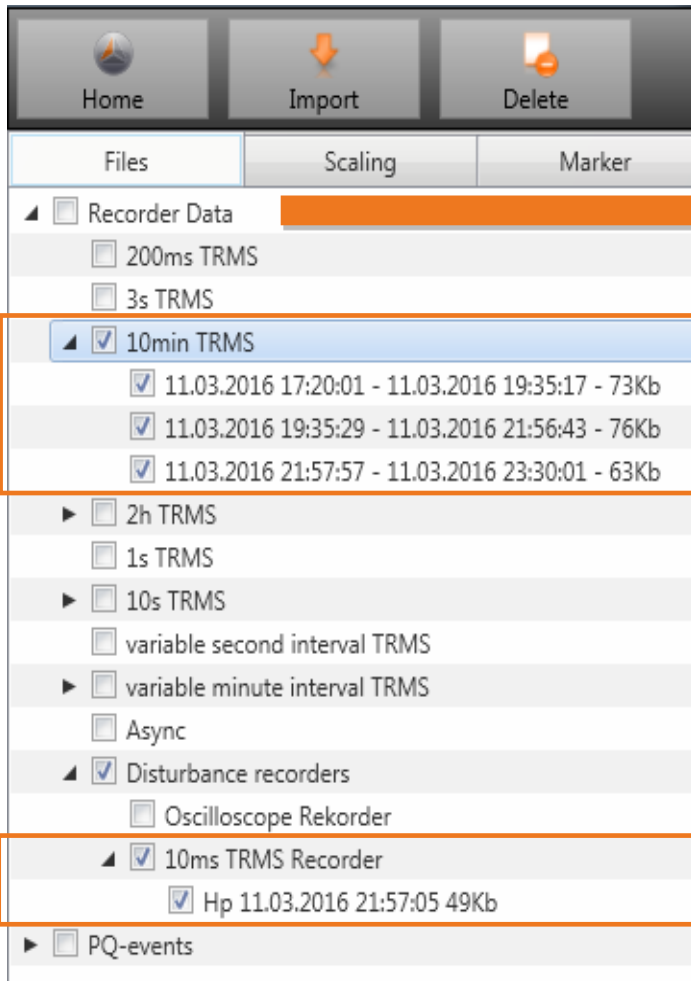

Home Import Delete

Files Scaling Marker

- Recorder Data
  - 200ms TRMS
  - 3s TRMS
  - 10min TRMS
    - 11.03.2016 17:20:01 - 11.03.2016 19:35:17 - 73Kb
    - 11.03.2016 19:35:29 - 11.03.2016 21:56:43 - 76Kb
    - 11.03.2016 21:57:57 - 11.03.2016 23:30:01 - 63Kb
  - 2h TRMS
  - 1s TRMS
  - 10s TRMS
  - variable second interval TRMS
  - variable minute interval TRMS
  - Async
  - Disturbance recorders
    - Oscilloscope Rekorder
    - 10ms TRMS Recorder
      - Hp 11.03.2016 21:57:05 49Kb
  - PQ-events

Selecting the main folder "recorder date" will activate all available data for download

Select the interval data classes  
3 permanent recorder files available

Select the number of the triggered sequence of events recordings (oscilloscope and ½ cycle RMS recorder)

We take care of it.

► **Level-time diagram of permanent measuring data**

When a file is selected this measurement data is saved on the PC immediately and a selection field with all available measurement data appears in the window.

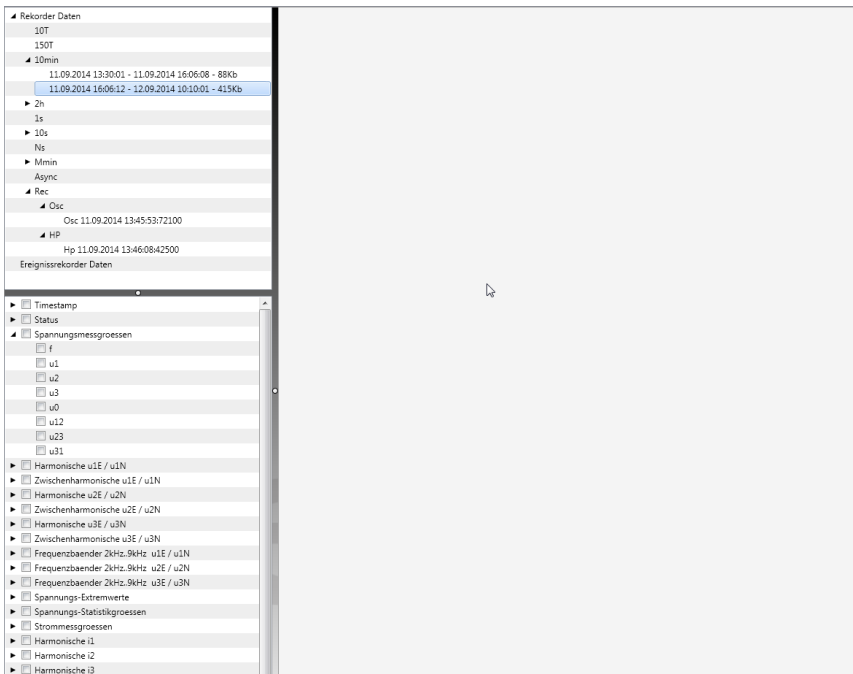

If measurement values are selected, they appear as a level-time diagram on the screen.

Example: Oscilloscope recorder – selecting voltage L1, L2, L3, L12, L23, L31

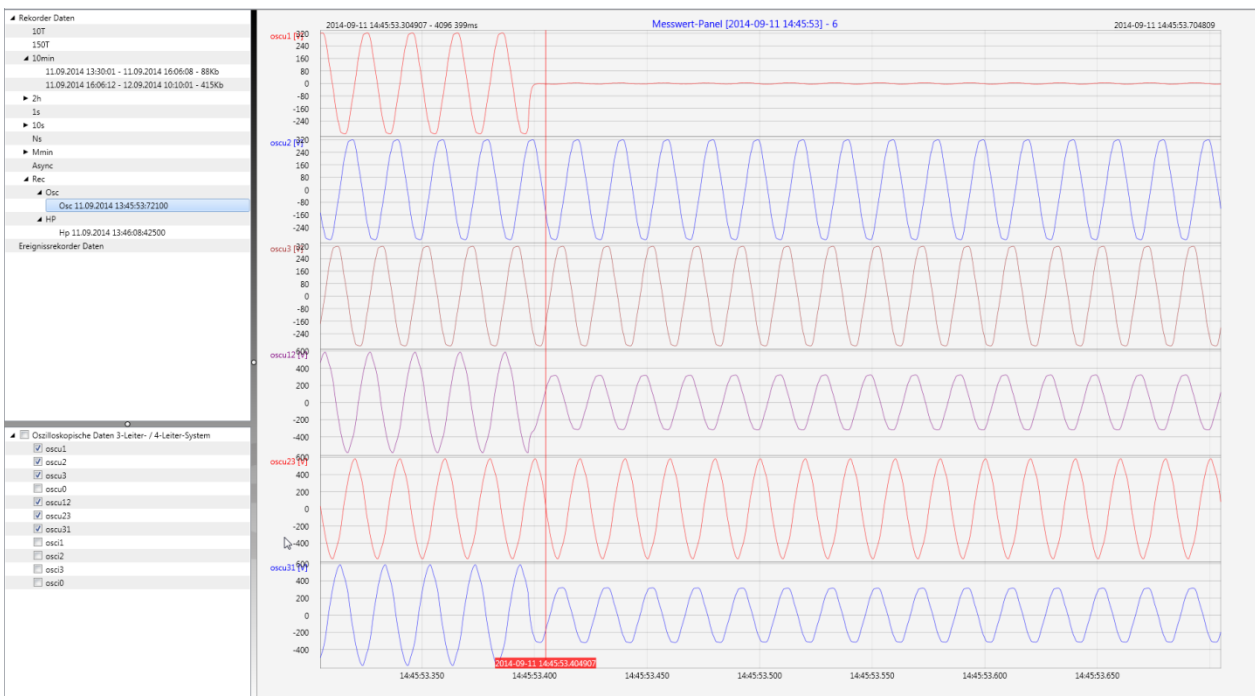



Right-clicking the graphics with the mouse will open the following menu:

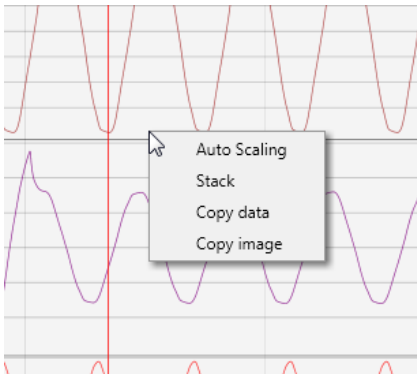

► **Functions:**

- **Auto scaling:** The Y-axis of the measurement values is scaled automatically or can be scaled manually.

A Menu appears where the last measurement can be scaled free or automatic

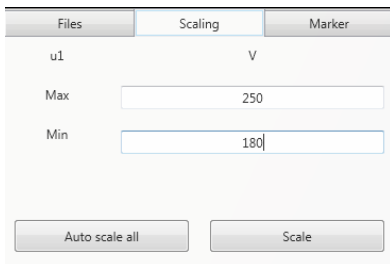

- **Stack** – associated measurement data can be represented with a common scale or separated



*Example: presentation of voltage L1, L2, L3 in two variants*

We take care of it.

---

- **Copy data:** Measurement data is copied to the clipboard and can be processed further, e.g. in MS Excel.
- **Copy Image:** Copies the level-time diagram to the Windows clipboard and can then be inserted, e.g. in MS Word.

## 7.8 Deleting measurement data in the device memory

With the "Delete" function, measurement data can be deleted in the PQI-DA *smart* device memory.

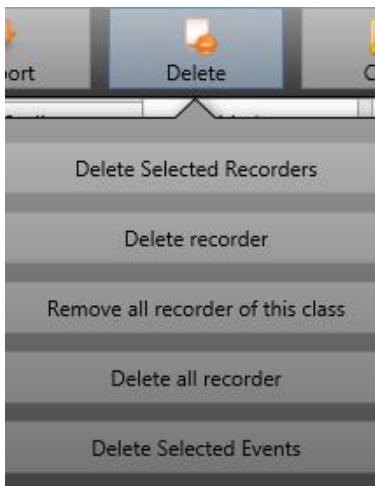

**Delete selected recorders** – deletes only selected files.

**Delete recorder** - deletes all recorder file.

**Remove all recorders of this class** - deletes e.g. all 10-minute data files.

**Delete all records** – All disturbance recordings and long-term measurement data on the device memory are deleted.

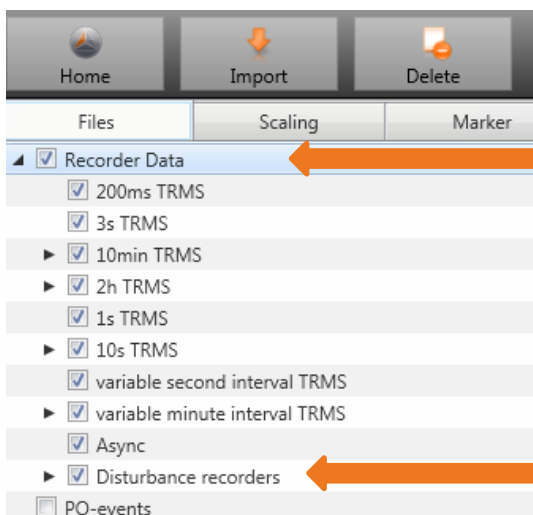

Main folder mark all data files

Mark only selected files to delete only these records.

I.e. the disturbance records which were recorded during installation

## 7.9 Evaluating measurement data offline



The "Archive" function can be used to evaluate all measurement data offline.

All measurement data which has been selected in the "Import" function is saved automatically on the PC. These can be evaluated offline without being connected to the measuring device.

Screen: Data folder

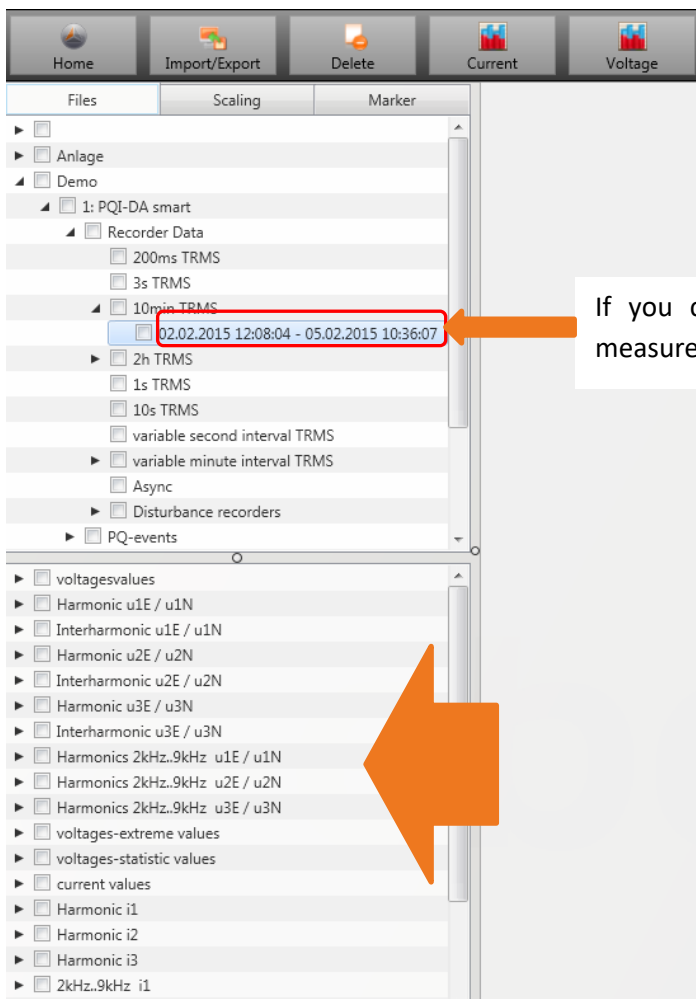

If you click on the file all available measurement data appear.

We take care of it.

---

When measurement values or measuring channels have been selected, the associated level-time diagram appears.

Example: selection voltage extreme value and 5<sup>th</sup> harmonic L1

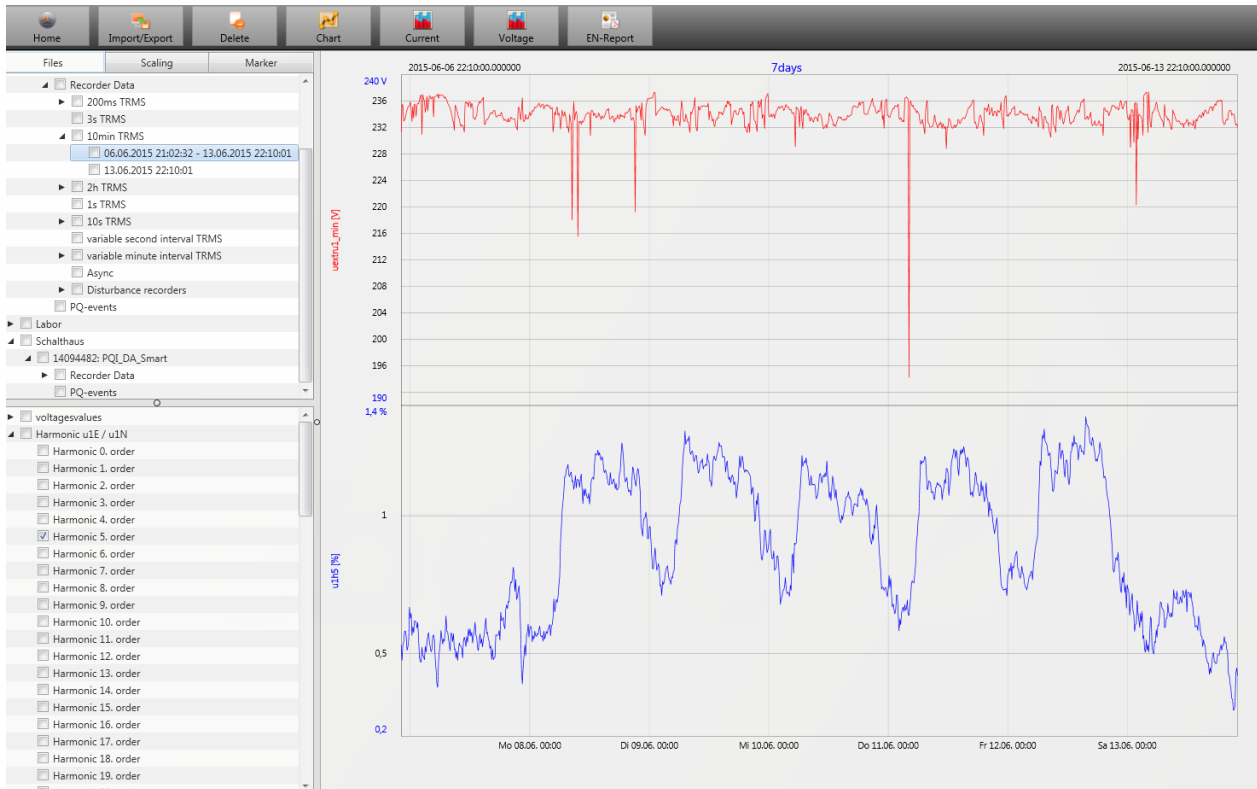

### 7.9.1 Edit measurement data

With the icon "Chart", the following functions are available:

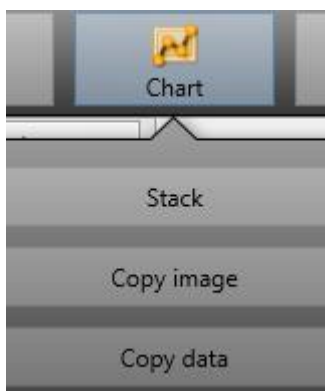

► **Copy data – copies all the data displayed in the Windows clipboard**

Example – measurement values in MS Excel

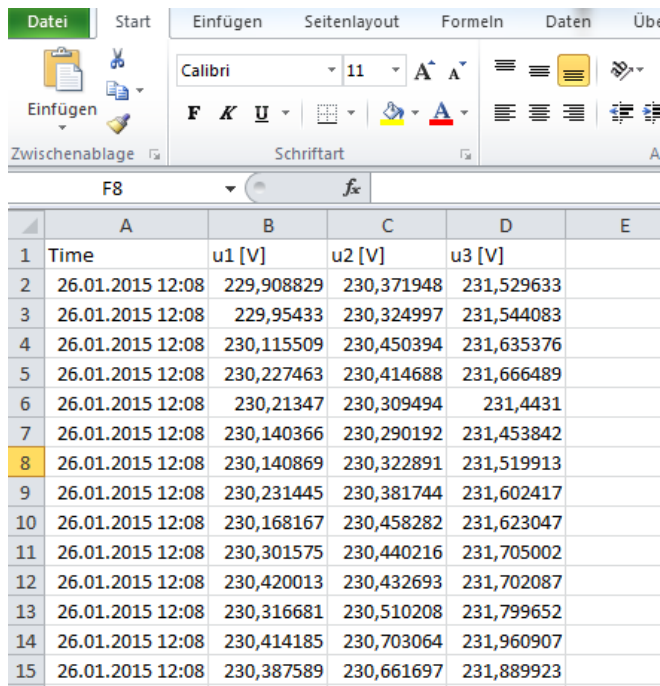

	A	B	C	D	E
1	Time	u1 [V]	u2 [V]	u3 [V]	
2	26.01.2015 12:08	229,908829	230,371948	231,529633	
3	26.01.2015 12:08	229,95433	230,324997	231,544083	
4	26.01.2015 12:08	230,115509	230,450394	231,635376	
5	26.01.2015 12:08	230,227463	230,414688	231,666489	
6	26.01.2015 12:08	230,21347	230,309494	231,4431	
7	26.01.2015 12:08	230,140366	230,290192	231,453842	
8	26.01.2015 12:08	230,140869	230,322891	231,519913	
9	26.01.2015 12:08	230,231445	230,381744	231,602417	
10	26.01.2015 12:08	230,168167	230,458282	231,623047	
11	26.01.2015 12:08	230,301575	230,440216	231,705002	
12	26.01.2015 12:08	230,420013	230,432693	231,702087	
13	26.01.2015 12:08	230,316681	230,510208	231,799652	
14	26.01.2015 12:08	230,414185	230,703064	231,960907	
15	26.01.2015 12:08	230,387589	230,661697	231,889923	

► **Copy image – photo is copied to the Windows clipboard**

► **Zoom function**

To zoom in an area you draw with the left mouse button a window from top left to bottom right. To zoom out is the opposite direction. You can zoom in multiple stages or zoom out an image.

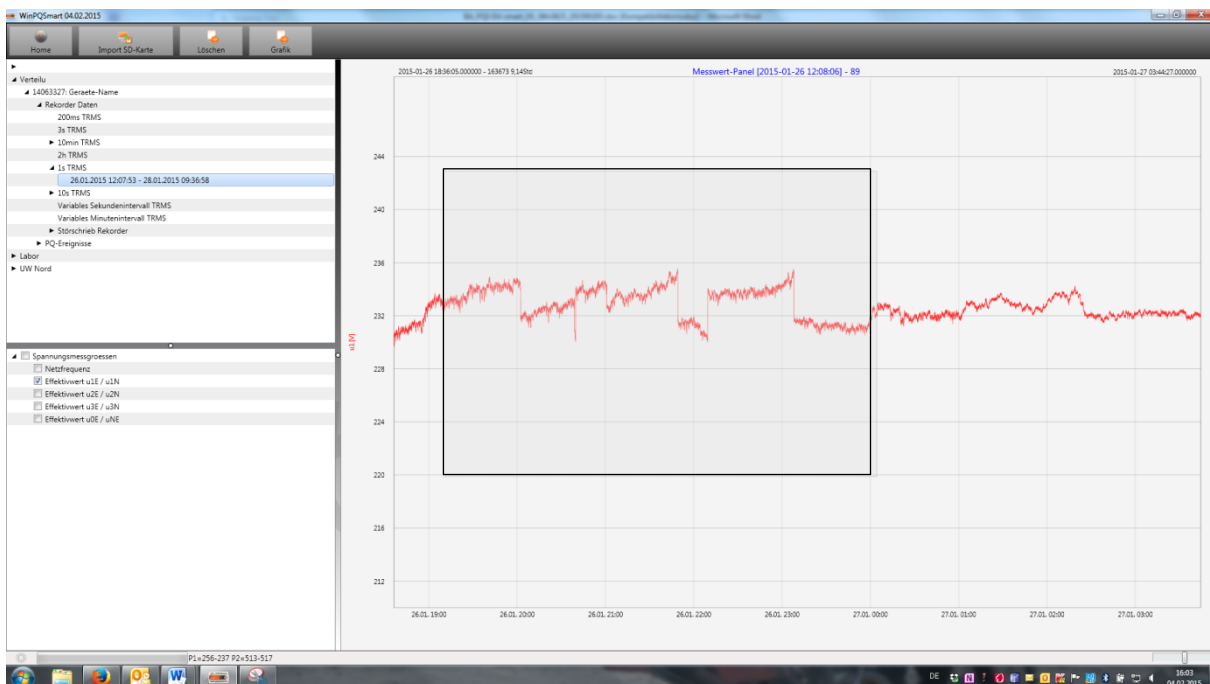

## 7.9.2 EN50160 report

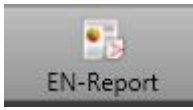

In the 10 minute data class, the EN50160 report is readily available. If you select one measurement file a multipage report is created.

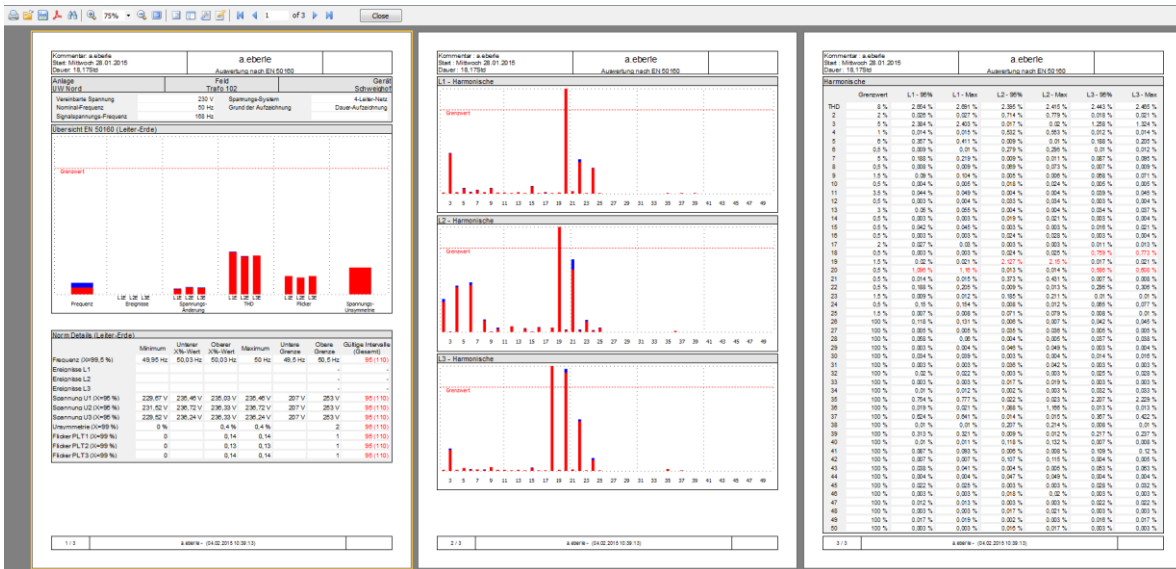

## 7.9.3 Voltage harmonics and interharmonics



With the Icon "Voltage" you can reach the statistics of the voltage harmonics, voltage interharmonics and frequency bands 2 kHz to 9 kHz.

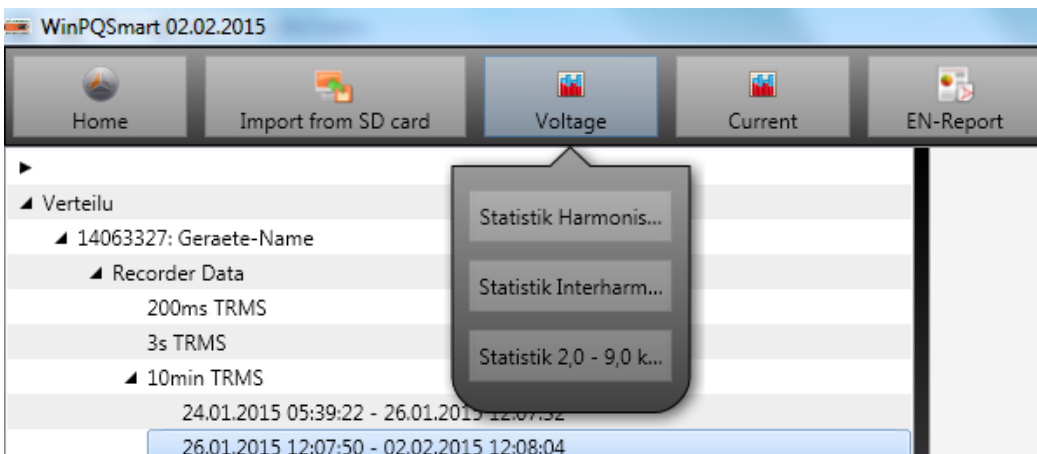

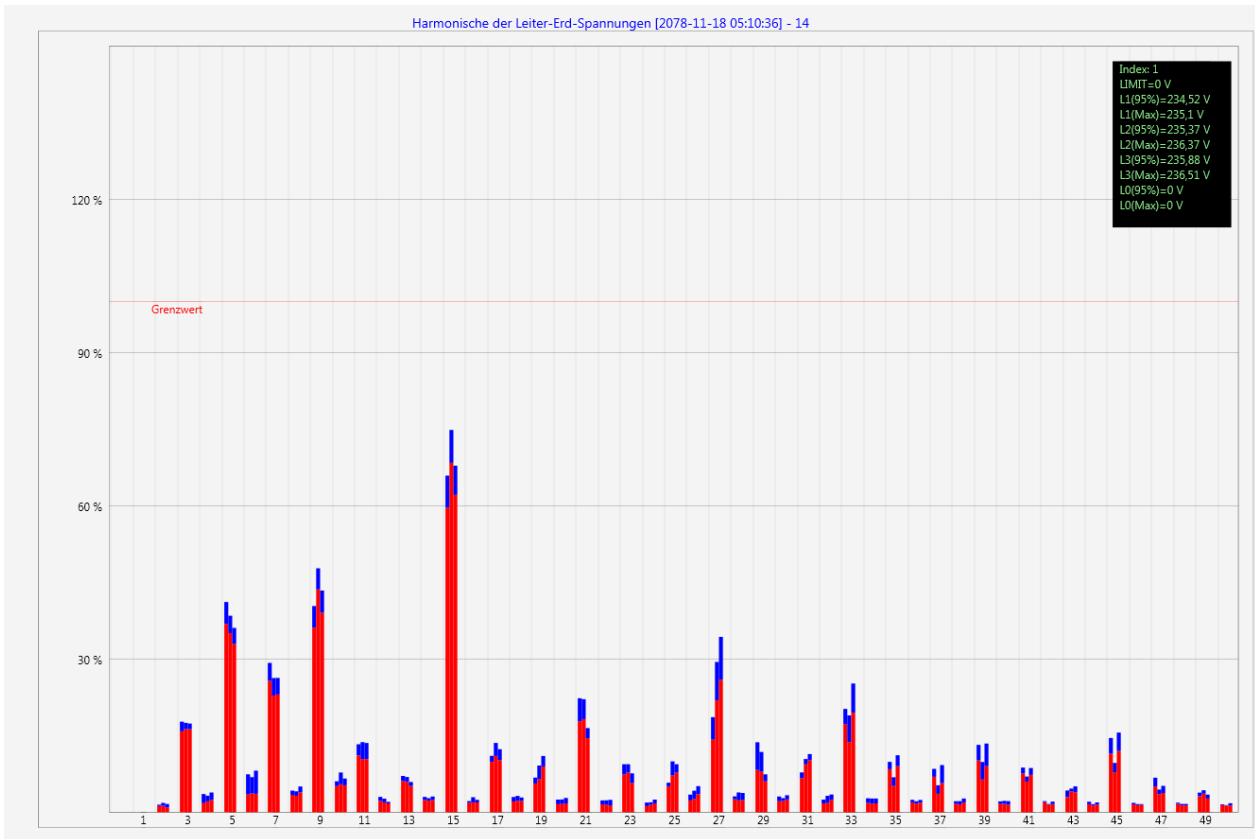

Statistic voltage harmonic - scaled to the corresponding compatibility level of the power quality standard.

### 7.9.4 Current harmonics and interharmonics

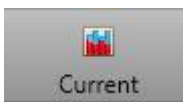

With the Icon "Voltage" you can reach the statistics of the voltage harmonics, voltage interharmonics and frequency bands 2 kHz to 9 kHz.

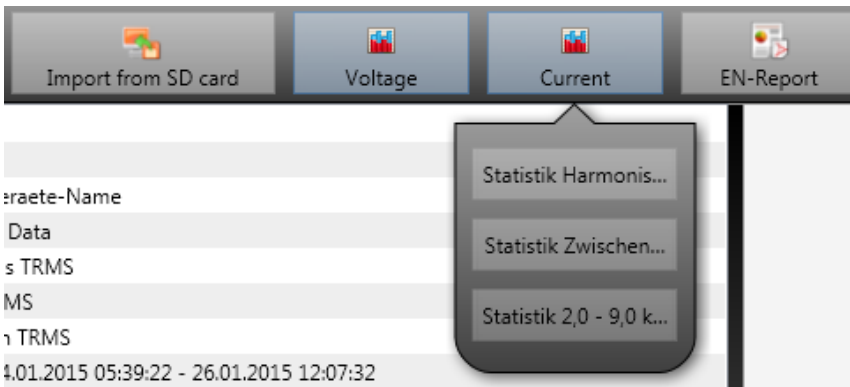

We take care of it.

---

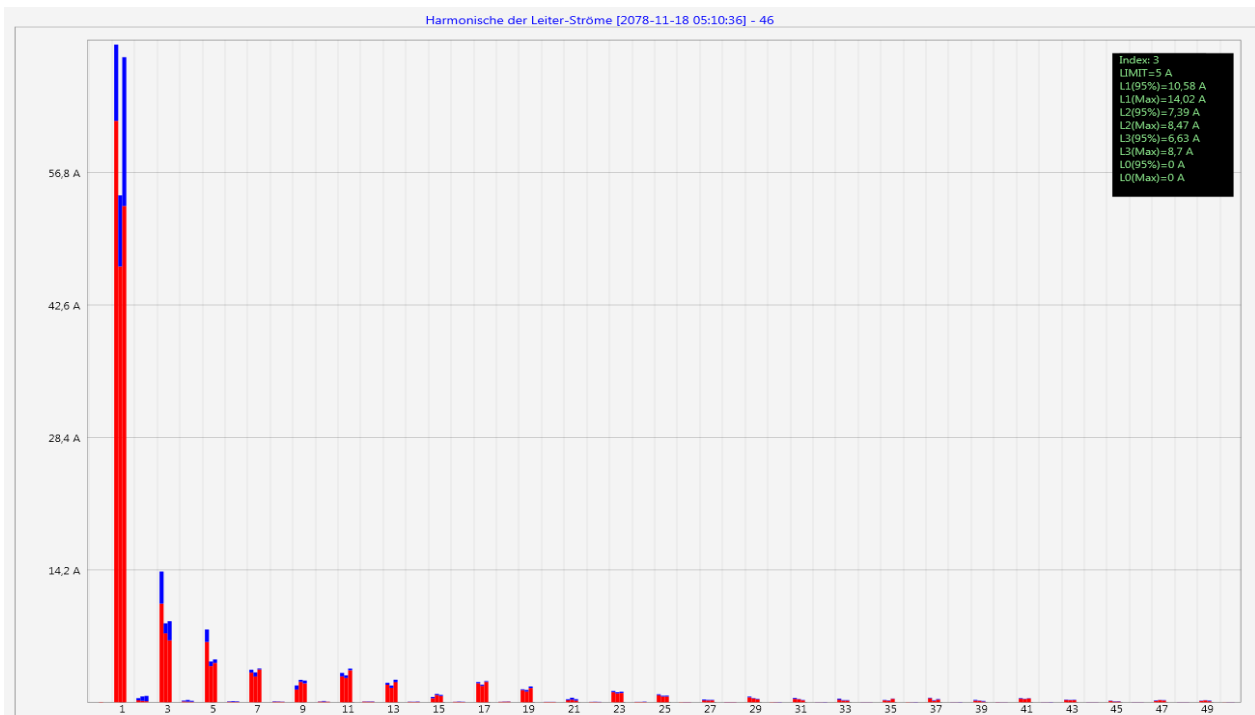

Example: Statistic current harmonics 2nd to 50th - scaling in ampere

If you select with the cursor a particular harmonic, the corresponding measured values are displayed for these harmonics in the display window.

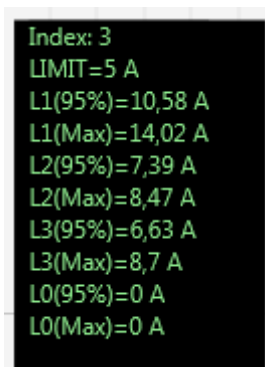

The red bar always shows the 95% values and the blue bar shows the maximum measured value.

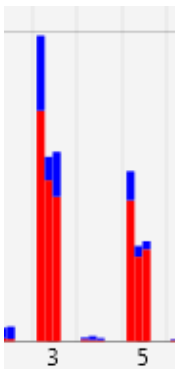



## 7.10 Importing measurement data from an SD card

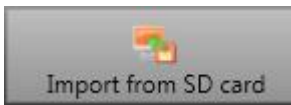

The function "Import from SD card" is used to transfer selected measurement data from the SD memory card to the PC.

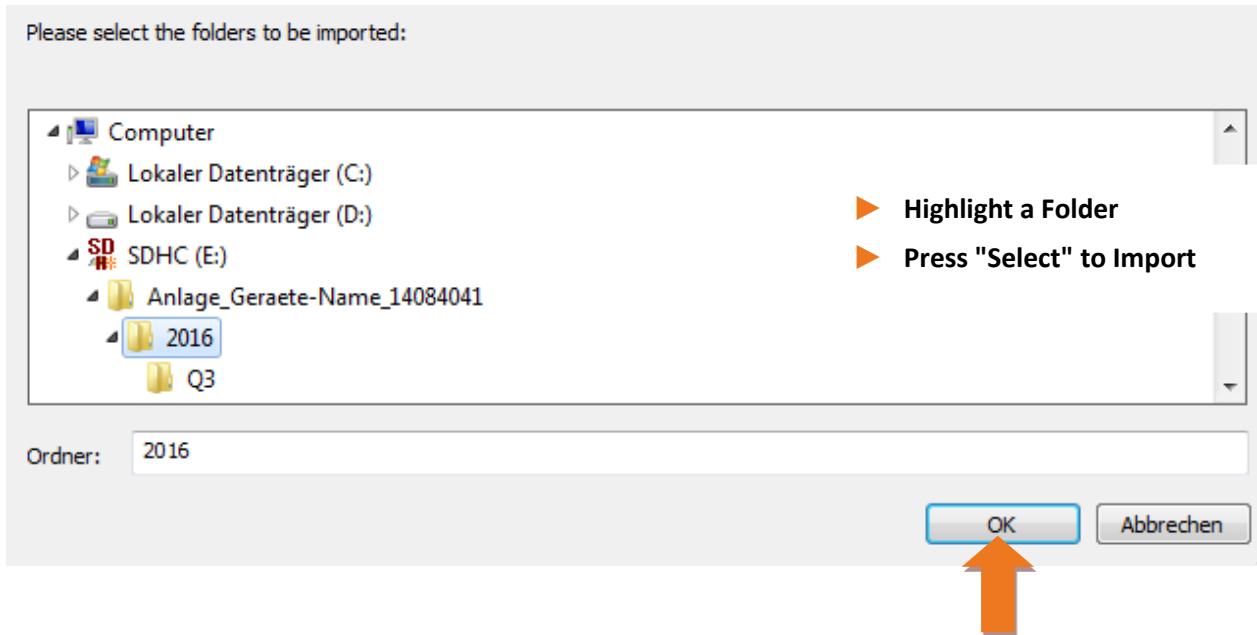

We take care of it.

---

## 8. Online Diagnostic

With the help of online diagnostics, the most important information of the PQI-DA *smarts* can be read out via Streaming. The device status can be seen as well as the complete device properties.

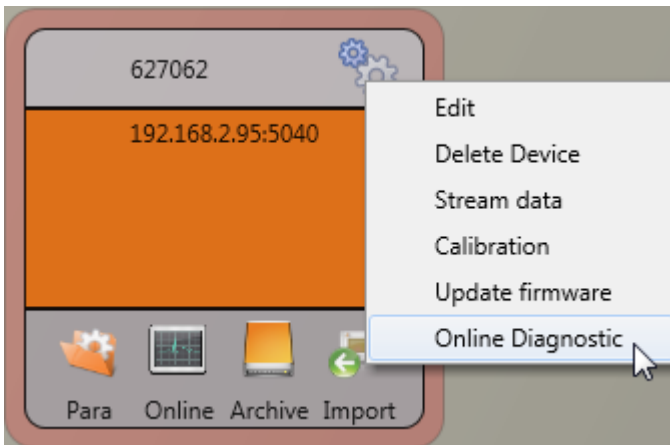

In the "**Device information**" part, the device log file can be loaded from the device using the **Logfile** button.

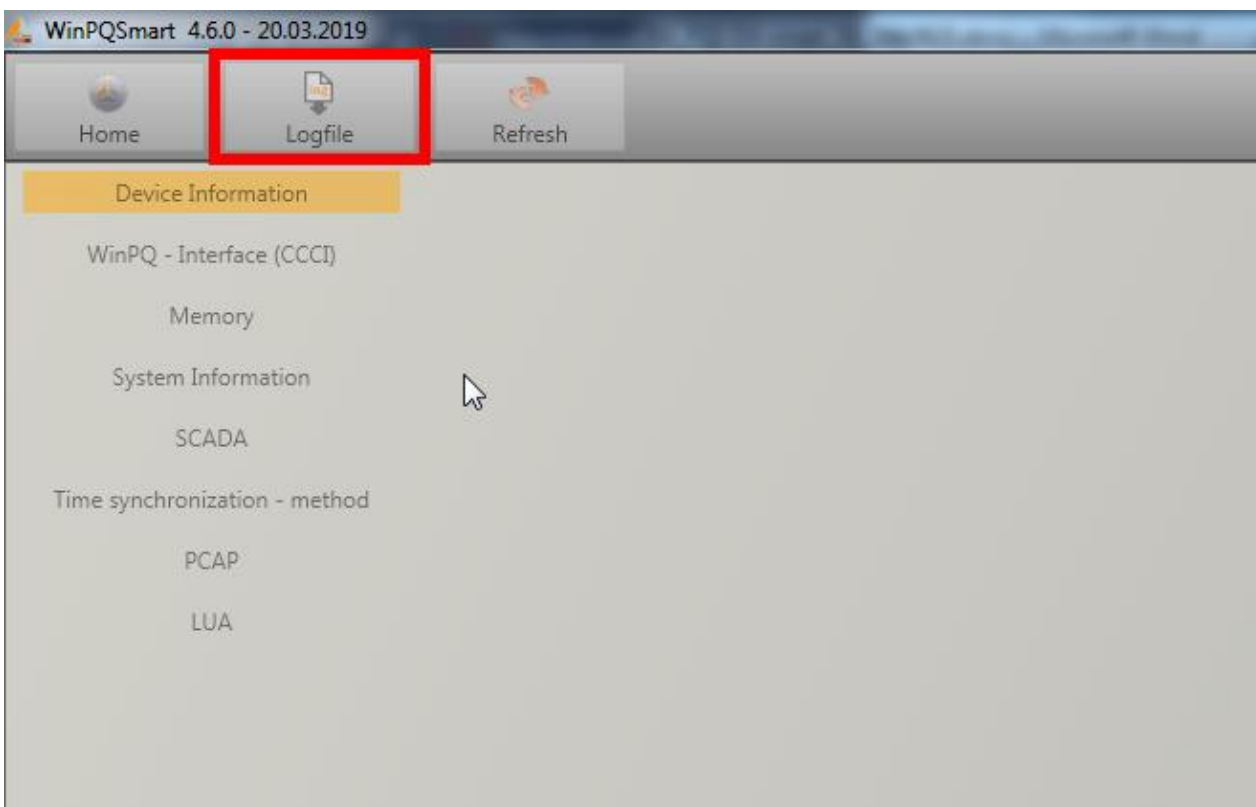

## 9. User database and access rights

The measuring device is equipped with a user role and user rights concept including user database, which corresponds to the current IT security guidelines.

The main functions are:

- Any number of users can be stored in the device with uniquely identifiable names.
- The users are to be assigned to a role.
- The roles (administrator, operator and user) define the rights.
- The detailed descriptions of the rights and roles with specification of the rights are listed in the security documentation.



The detailed description of the rights and roles with specification of the rights is listed in the security documentation.

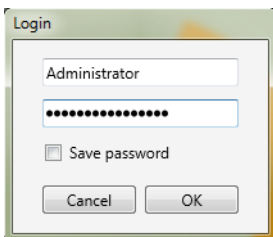

Whenever a function is called from the WinPQ lite software, such as Read parameterization (Para), Online data (Online), Data Explorer (Import), the encoder checks by entering the user name and password whether the user has the required rights for this function.

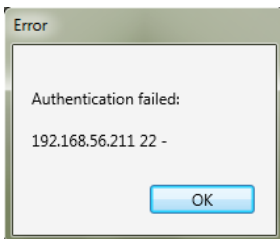

If the password and or the user name are entered incorrectly or if the user does not have the right to access a function, this is reported back accordingly.

- If incorrect entries are made, the connection to the meter via the SSH tunnel is automatically disconnected!
- The number of failed attempts (factory setting: 3) before a user is locked for a certain time (factory setting: 1 hour) can be set.
- Failed attempts are logged internally and output via Syslog and can also be queried via the user administration.



## 9.1 Adding and Editing Users

If the meter is set up in Security Mode (see chapter 6.2) any number of users can be created in the meter. During the first setup, one user each for the roles "User", "Operator", "Administrator" and, if applicable, "Machine-to-Machine" was stored in the measuring device. To store additional users or edit, block or delete users that have already been created, proceed as follows:

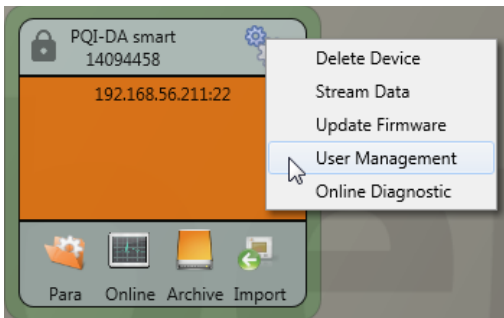

Click on "Edit user" in the device settings.

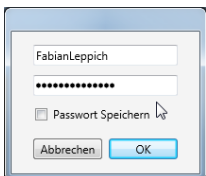

Enter the user name of the administrator and the corresponding password.

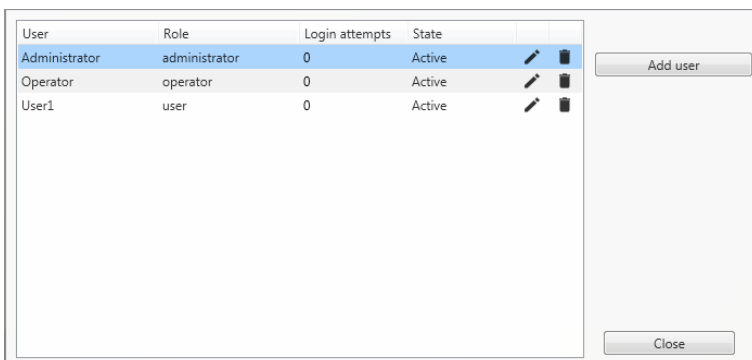

User information is downloaded from the meter and displayed.

### ▶ Functions:



If clicking on "Edit user" or on "Add user", an input mask for the parameterisation of the user opens.

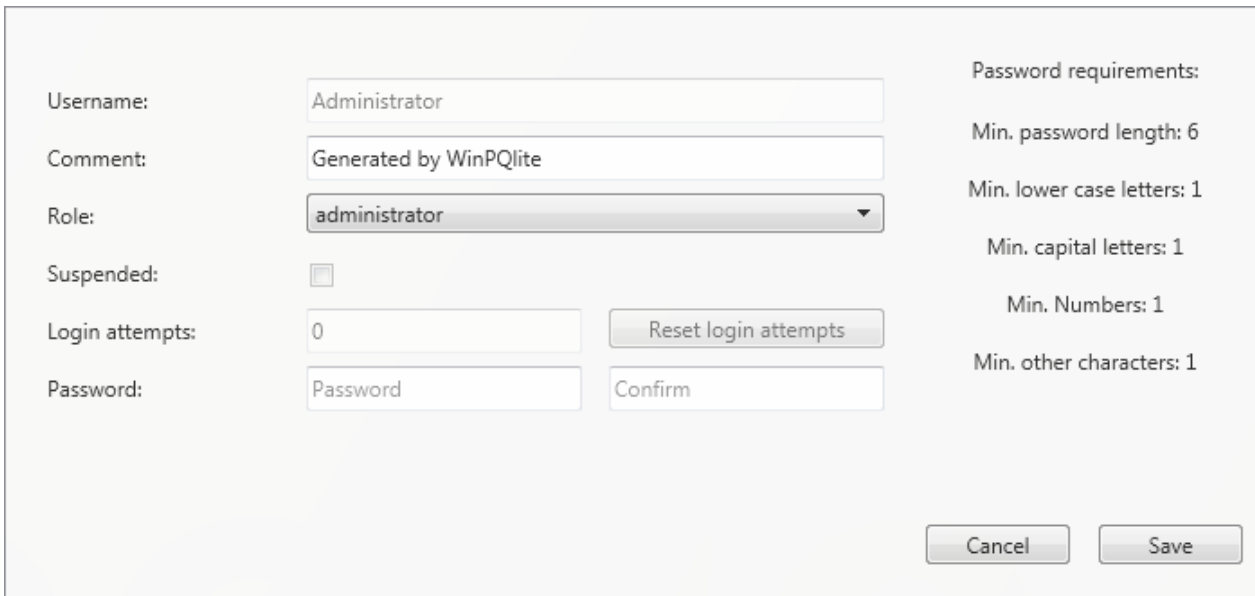

The form contains the following fields and options:

- Username:** Administrator
- Comment:** Generated by WinPQlite
- Role:** administrator (dropdown menu)
- Suspended:**
- Login attempts:** 0 (with a "Reset login attempts" button)
- Password:** Password (with a "Confirm" field)
- Password requirements:**
  - Min. password length: 6
  - Min. lower case letters: 1
  - Min. capital letters: 1
  - Min. Numbers: 1
  - Min. other characters: 1
- Buttons:** Cancel, Save

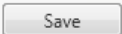
Click on  to transfer the settings to the instrument, store them and activate them from this point on.

## 9.2 IT security settings and password requirements

The administrator has the possibility to specify the assignment of passwords via the so-called password policy. Proceed as follows to make the settings:

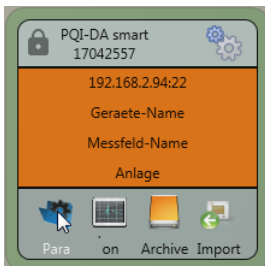

Click on "**Para**" to download the complete instrument parameterization from the measuring instrument.

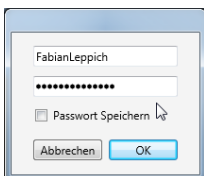

Enter the user name of the administrator and the associated password, since the policy can only be set by the administrator.

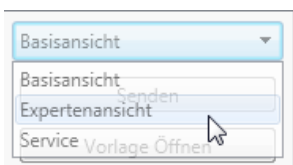

Changing the interface from the basic view to the **expert view**

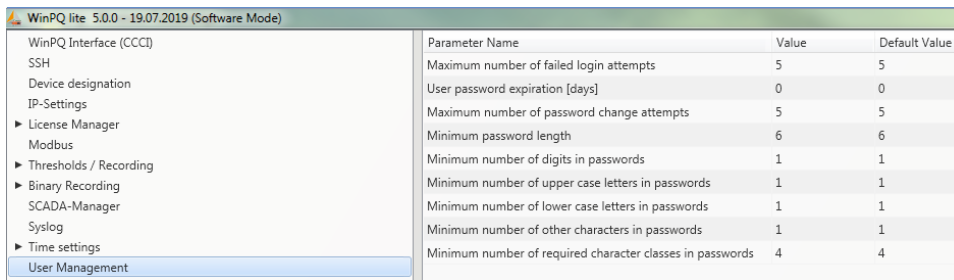

The screenshot shows the WinPQ software interface in 'Software Mode'. The left sidebar contains a tree view with 'User Management' selected. The main area displays a table of parameters:

Parameter Name	Value	Default Value
Maximum number of failed login attempts	5	5
User password expiration [days]	0	0
Maximum number of password change attempts	5	5
Minimum password length	6	6
Minimum number of digits in passwords	1	1
Minimum number of upper case letters in passwords	1	1
Minimum number of lower case letters in passwords	1	1
Minimum number of other characters in passwords	1	1
Minimum number of required character classes in passwords	4	4

In the menu item "**User administration parameters**" the following necessary parameters can be defined in addition to the password guidelines:

- **Maximum number of failed logon attempts:** Number of logon attempts on the device before a user can log on to the device again for a configurable time (factory setting: 1 hour). The parameter can be freely set via the SSH console if required for the lockout period.
- **User password expiration [days]:** After the set days have expired, the user can no longer log on to the device without having to change the password.
- **Maximum number of password change attempts:** Number of attempts to change the password on the device.

The password should be as complex as possible!



It is always recommended to adhere to the relevant known and country-specific guidelines!

Germany: It is recommended to adhere to the guidelines for passwords of the Federal Office for Information Security (BSI).

## 10. Firmware update for PQI-DA *smart*

Power Quality devices are constantly evolving in terms of functions and standards. It may therefore become necessary to update a device, e.g. due to changes in standards, new functions or necessary (security) patches. You will find the latest firmware version with a transparent changelog to check whether an update is necessary using the following link:

For a firmware update administrative rights are necessary!

<https://www.a-eberle.de/en/download-center-categories/f%C3%BCr-festinstallierte-ger%C3%A4te-0>

A.Eberle generally provides two firmware packages which differ in their function:

### ► Incremental update (patch) - available on the homepage

The incremental update does not change any parameters or settings. It also does not delete any measurement data, but only updates the changes to the last version.

The file name is e.g. "PQI-DA\_Smart\_v1.8.10\_11544.zip". The incremental update is the common way to bring the measuring instruments up to date.

### ► Factory Update - only available on request

This update deletes all settings including all recorded data and resets the device to factory settings. The file name of the update has the extension "factory" Example: "PQI-DA\_Smart\_\*\*factory\*\*\_v1.8.10\_11544.zip". The factory update should only be used in consultation with product support.

### 10.1 Firmware update with software WinPQ lite

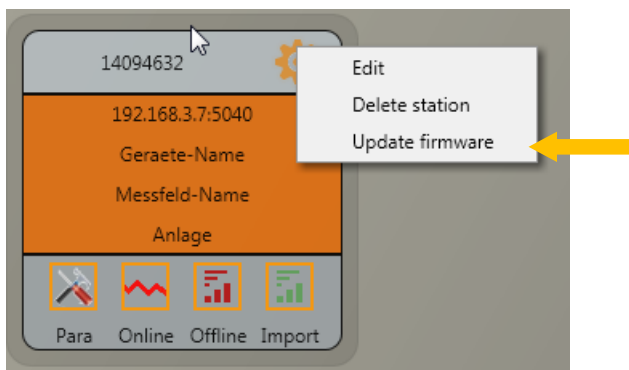

The "General setup" device function tile can be used to carry out a firmware update for the PQI-DA *smart* measuring device.

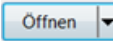
- Select the folder where the file for the firmware update is located.
- The  function is used to transfer the firmware to the network analyser.

We take care of it.

---

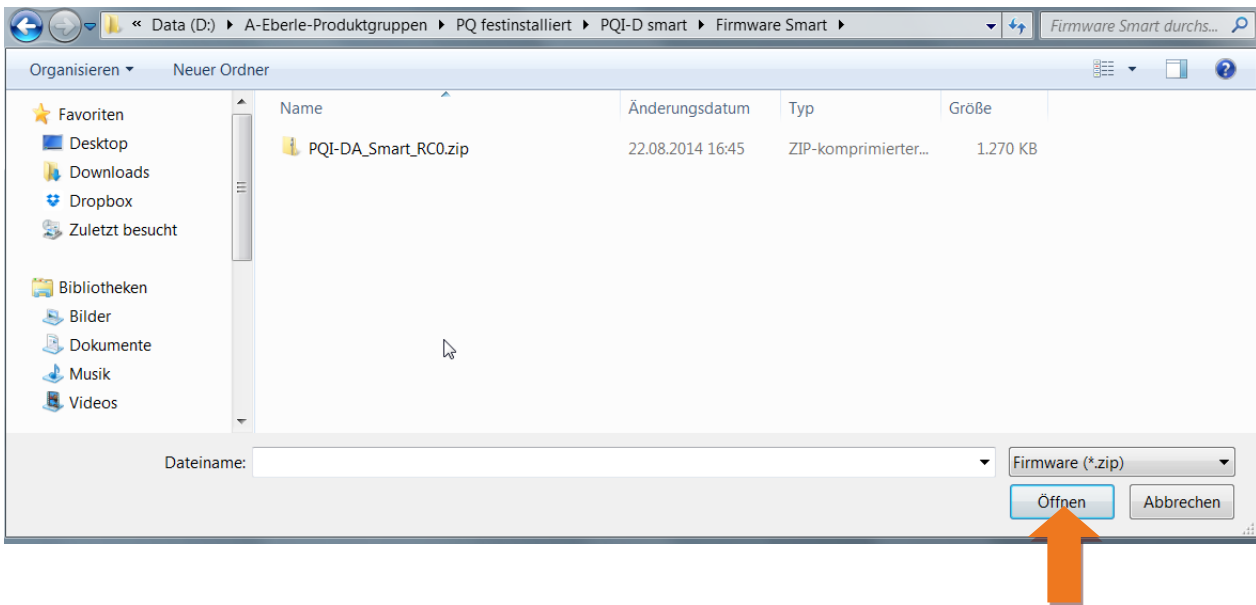

When the transfer of the firmware to the measuring device has been completed, it will automatically restart and install the new version.

## 10.2 Firmware update with SD - card

Additional to the WinPQ lite software update, it is also possible to update the firmware of the PQI-DA *smart* measuring device using an SD memory card. To do this, please proceed as follows:

For safety reasons, a firmware update is not possible via the SD card from firmware V2.0 onwards in the switched-on safety mode. The administrator must always be logged in and the update must be performed via the software.

- Unpack the firmware file (zip file e.g. PQI-DA\_Smart\_v1.8.10\_11544.zip) directly into the root directory of the SD card used. Accordingly, the following files can be found on the SD card in the top directory:

Name	Typ	Komprimierte Größe
readme.txt	Textdokument	2 KB
update.md5	MDS-Datei	1 KB
update.tgz	TGZ-Datei	3.463 KB

- Before inserting the SD card into the slot of the PQI-DA *smarts*, please check that the write protection switch of the SD card is set to "unlocked". (This is mostly "up", see picture)

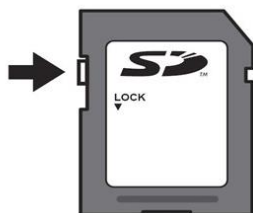

- Insert the SD card into the SD card slot on the PQI-DA *smart*. If there is a suitable firmware on an SD card, the measuring instrument automatically recognizes this file after insertion and the following message appears on the instrument display.



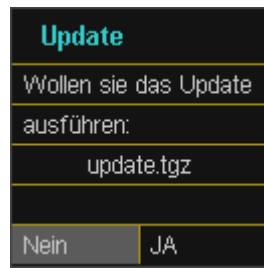

- The firmware update is carried out automatically by pressing the "YES" button. The process can take up to 5 minutes.
- The device restarts after successful installation.

### 10.3 Automatic Firmware Update of Many Devices

Using the WinPQ system software, many PQI-DA *smarts* can be updated with just a few clicks, with full clarity and control. Further information can be found in the documentation "[WinPQ Commissioning Instructions](#)" of the WinPQ system software.

([https://www.a-eberle.de/sites/default/files/media/ba\\_WinPQ\\_Commissioning\\_en.pdf](https://www.a-eberle.de/sites/default/files/media/ba_WinPQ_Commissioning_en.pdf))

## 11. Calibration PQI-DA *smart* (license required)

The power quality network analyser PQI-DA *smart* is ex work calibrated and delivered with a corresponding test report certificate

Depending on the application, calibration and adjustment can also be carried out directly at the installation site using the additional software. This software functionality is subject to licensing and can be enabled using a license code.

### 11.1 Requirements for calibration equipment

According IEC61000-4-30 class A the PQI-DA *smart* has an accuracy of < 0.1% for voltage measurement. The reference measurement device must meet a minimum accuracy of 0.02% (e.g. Fluke 8508A or Agilent multimeter 34410 A). The voltage source has to deliver a sinus signal with 100 V (50 or 60 Hz) with a THD > 0.1%. In addition a current source with a sinus-shaped signal of 5A (50 of 60 Hz) is required.

### 11.2 Calibration process with the WinPQ lite software

The calibration process with the WinPQ lite is completely guided by an assistant. The complete process with the corresponding instructions is described by the software wizard. The calibration wizard is started by the settings menu of a PQI-DA *smart*, see next figure.

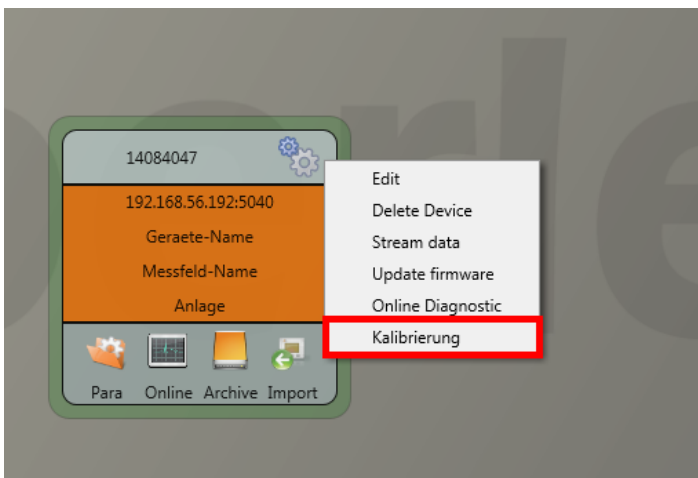

Starting the calibration requires a valid license key. Please enter the key in the corresponding input field on the start screen page.

The wizard guides the user through the complete calibration process. Please follow the instructions of the assistant.

## 11.2.1 Steps of calibration

All steps for calibrating the meter are listed below. It is important that the corresponding reference measuring instruments are at hand to successfully complete the calibration with adjustment.

For the calibration it is necessary to separate the measuring instrument from the supply voltages and currents (separating elements)!

Notice!

**Measuring error due to inaccurate reference measuring instrument**

➡ Before carrying out the calibration, the accuracy of the reference measuring instrument must be checked! Note Chapter 11.1.

### Calibration PQI-DA smart

The calibration of a PQI-DA smart is carried out step by step in the following. The requirements for the calibration equipment are:

According to the IEC61000-4-30 Class A standard, the PQI-DA smart must meet an accuracy of < 0.1%. For a reference instrument, a minimum accuracy of 0.02 % is required (example: Fluke 8508A or Agilent Multimeter 34410 A). The voltage source must provide a 100 V (50 or 60 Hz) sinusoidal signal with a distortion factor < 0.1 %. In addition, a current source is required that generates a sinusoidal current of 5 A (50 or 60 Hz).

To start the calibration a valid license code must be entered:

### Setup Calibration and test settings

Identification		Test	
Device Type	<input type="text" value="PQI-DA smart"/>	Name of Inspector	<input type="text"/>
Device Number	<input type="text" value="18021222"/>	Date of Inspection	<input type="text" value="19.06.2019"/>
Optional 1	<input type="text" value="Max 20"/>	Start of Test	<input type="text" value="14:08:42"/>
Optional 2	<input type="text" value="Max 20"/>		

Rules and Exam texts

We hereby confirm that the measuring instrument listed below complies with the specifications published by us. The measuring devices used for calibration are regularly calibrated against standards whose accuracy can be traced back to national and international standards or which are derived from calibration techniques. This calibration certificate may only be processed completely and unchanged. Extracts or changes require approval. Test certificates without signature and stamp are not valid.

### Specification of Test Conditions

Environmental Conditions		Tool
Air Temperature	<input type="text" value="15 °C ... 35 °C"/>	Program <input type="text" value="WinPQSmart 5.0.0 - 07.06.2019"/>
Relative Humidity	<input type="text" value="25 % ... 75 %"/>	
Air Pressure	<input type="text" value="86 kPa ... 106 kPa"/>	

Measurement Device

Model	Serial	Test Equipment No.	Calibrated to	Certificate No.
<input type="text" value="Model 1"/>	<input type="text" value="Serial No. 1"/>	<input type="text" value="Pesticide No. 1"/>	<input type="text" value="Date"/>	<input type="text" value="No."/>
<input type="text" value="Model 2"/>	<input type="text" value="Serial No. 2"/>	<input type="text" value="Pesticide No. 2"/>	<input type="text" value="Date"/>	<input type="text" value="No."/>

### Calibration PQI-DA smart

Implementation

Connect all voltage measurement inputs to earth potential and disconnect all current measurement inputs from the source.

Voltage = 0 V  
Current = 0 A

Advance

**Calibration PQI-DA smart**

Implementation

Please select the reference frequency for the calibration:

50 Hz  
 60 Hz

Advance

Disconnect Source

Select Frequency

Zero point measurement

Connect source

Compare reference

Check status

Finish calibration

Rerun calibration    Next

**Calibration PQI-DA smart**

Implementation

Please select the reference frequency for the calibration:

50 Hz  
 60 Hz

Advance

Disconnect Source

Select Frequency

Zero point measurement

Connect source

Compare reference

Check status

Finish calibration

Rerun calibration    Next

**Calibration PQI-DA smart**

Implementation

Please connect all voltage measurement inputs to the voltage source (all inputs parallel) and all current measurement inputs to the current source (all 4 inputs serial).

Set the following values on the calibrator:

Voltage = 100.00 V  
Current = 5.000 A  
Frequency = 50.000 Hz

Show connection

Advance

Disconnect Source

Select Frequency

Zero point measurement

Connect source

Compare reference

Check status

Finish calibration

Rerun calibration    Next

**Calibration PQI-DA smart**

Implementation

Show connection

Advance

Disconnect Source

Select Frequency

Zero point measurement

Connect source

Compare reference

Check status

Finish calibration

Rerun calibration    Next

**Calibration PQI-DA smart**

Implementation

Please connect all voltage measurement inputs to the voltage source (all inputs parallel) and all current measurement inputs to the current source (all 4 inputs serial).

Set the following values on the calibrator:

Voltage = 100.00 V  
Current = 5.000 A  
Frequency = 50.000 Hz

Show connection

Advance

Disconnect Source

Select Frequency

Zero point measurement

Connect source

Compare reference

Check status

Finish calibration

Rerun calibration    Next

**Calibration PQI-DA smart**

Implementation

The set reference values should be checked with a multimeter.

Enter the values of the control measurement:

Voltage (V):     Current (A):

Advance

Disconnect Source

Select Frequency

Zero point measurement

Connect source

Compare reference

Check status

Finish calibration

Rerun calibration    Next

**Calibration PQI-DA smart**

Implementation

The set reference values should be checked with a multimeter.

Enter the values of the control measurement:

Voltage (V):  Current (A):

Advance

- Disconnect Source
- Select Frequency
- Zero point measurement
- Connect source
- Compare reference
- Check status
- Finish calibration

**Calibration PQI-DA smart**

Implementation

The set reference values should be checked with a multimeter.

Enter the values of the control measurement:

Voltage (V):  Current (A):

Advance

- Disconnect Source
- Select Frequency
- Zero point measurement
- Connect source
- Compare reference
- Check status
- Finish calibration

**Calibration PQI-DA smart** ✕

Implementation

Check calibration status:

- I3 : Calibration ok ✓
- I4 : Calibration ok ✓
- U1 : Calibration ok ✓
- U2 : Calibration ok ✓
- U3 : Calibration ok ✓
- U4 : Calibration ok ✓
- I1 : Calibration ok ✓
- I2 : Calibration ok ✓
- I3 : Calibration ok ✓
- I4 : Calibration ok ✓

Result:

Calibration successful!

Advance

- Disconnect Source
- Select Frequency
- Zero point measurement
- Connect source
- Compare reference
- Check status
- Finish calibration

↻ Rerun calibration Save and Exit ➔



## 12. License Update PQI-DA *smart*

The network analyser PQI-DA Smart can be equipped with various options. These options can be activated via a license code, even after the purchase, at any time.

To order an option the following information to create a license codes are required:

- Serial number of the instrument
- Article number of the instrument
- Option to install

If you received a valid license for the connected device please paste it to the device setting.

Example: Upgrading Option 40.96 kHz for PQI-DA *smart*



Info	Value	Default	Minimum	Maximum
expiration date	2106-02-06	0	0	100
Licence key	14094632-d1675ccd-8c312736-7f696a06	ReadOnly	ReadOnly	ReadOnly

▶ The following options are available:

- 40.96kHz sampling (2kHz to 9kHz harmonic measurement)
- IEC 60870-5-104
- IEC 61850

## 13. SCADA

### SCADA settings

In the device settings "SCADA" the following protocols can be selected:

- Modbus – supplied as standard
- IEC60870-104 – chargeable device option
- IEC61850 – chargeable device option

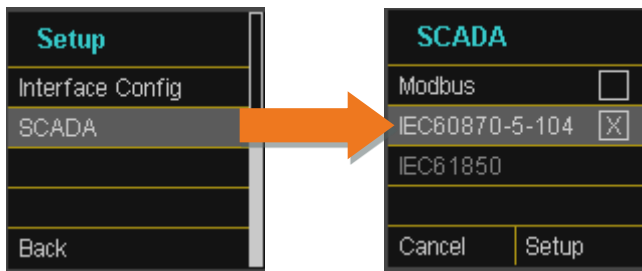

### 13.1 Modbus

The following data classes and events are available in the PQI-DA *smart* via Modbus TCP or Modbus RTU:

- 200ms data class (frequency, voltage L1, L2, L3)
- 1 sec data class (all measurement values)
- 10 min data class (all measurement values)
- N x min data class (power measurement values)
- 2h data class Plt long term flicker value
- Status of two binary inputs
- Power Quality and disturbance event counter (display PQI-DA *smart*)
- Endless counter for disturbance recorder
- Power Quality settings – write Modbus

#### 13.1.1 Modbus data list

Please download the extensive Modbus data point list from our website [www.a-eberle.de](http://www.a-eberle.de)

For Modbus there are over 5000 measurement values available.



### 13.1.2 Modbus settings

Settings of the Modbus TCP and Modbus RTU interface can be changed via the device setup.

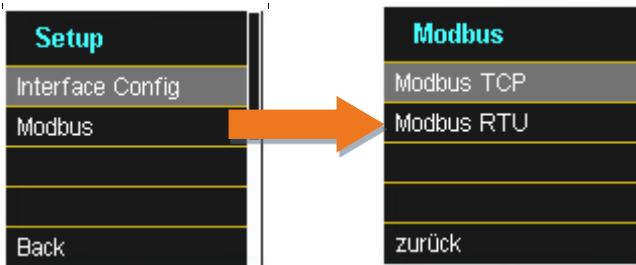

### 13.1.3 Modbus RTU

You can enable Modbus RTU. Modbus interface is fixed assigned to COM1

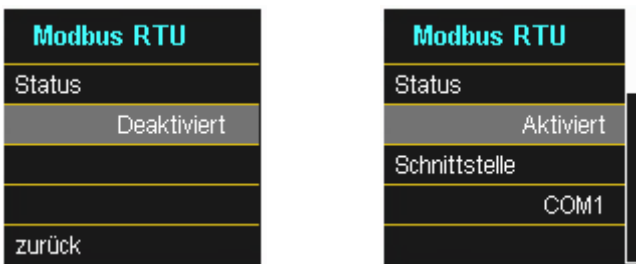

The interface can be changed to Modbus RTU RS232 or RS485.



### 13.1.4 Modbus TCP

Modbus TCP is deactivated by default and can be enabled at this point. The port number can be set-up.

Modbus TCP	
Status	Aktiviert
Port	502
zurück	

### 13.1.5 Set-up parameter Modbus with WinPQ

	Parametername:	Wert:	Werkseinstellung:
WinPQ Interface (CCCI) device designation IP-Settings ▶ License Manager Modbus NTP ▶ Thresholds / Recording ▶ Binary Recording SCADA-Manager Syslog ▶ Timedaemon	TCP Server activated	1	1
	RTU Server activated	0	0
	TCP Port	502	502
	TCP endianness	Little-Endian	▼ Little-Endian
	Serial Interface	COM 1	▼ COM 1
	RTU Slave ID	17	17
	RTU endianness	Little-Endian	▼ Little-Endian
	Baud rate	115200	▼ 115200
	Parity	None	▼ None
	Interface mode	RS232	▼ RS232

The Modbus TCP and Modbus RTU interfaces can be modified via the WinPQ lite software. Modbus could be activated via the parameters TCP or RTU Server (0 = OFF / 1 = ON)

▶ **Parameter serial:**

- Serial Interface                      Selection of the COM interface used (COM1 / COM2)
- Baud rate                              Baud rate of the serial interface for Modbus RTU
- Parity                                    Serial port parity for Modbus RTU
- interface mode                        Switching between RS232 and RS 485
- RTU - byte order                      See 13.1.5.1

▶ **Parameter TCP/IP**

- TCP - Port                              Change of the TCP / IP Ports for Modbus TCP / IP
- RTU - byte order                      See 13.1.5.1

### 13.1.5.1 Byte Order

According to the Modbus specification, data is transmitted in the byte order Big-Endian. Regarding a 16-bit Modbus register, the data on the client side is interpreted without conversion. The following example illustrates this with the example value 0x1A2B:

Address	Communication (Big-Endian)	Client-Side (Big-Endian)
High Byte	0x1A	0x1A
Low Byte	0x2B	0x2B

### 13.1.5.1 Modbus-Register-Order

Interpreting the data transferred via multiple Modbus registers (e.g., 32 bits Unsigned Integer => 2 x 16 Bit Modbus registers), a distinction must be made between the Little-Endian and Big-Endian sequences. In this case, the entire register contents and not the bytes are exchanged. In the default configuration, the software is operated in Little-Endian mode. The following examples illustrate the variants:

▶ **32 Bit-value 0x1A2B3C4D - Modus Little-Endian:**

Address	Example (Big-Endian)	Communication (Little-Endian)	Client-Side (Big-Endian)
Register 0 High Byte	0x1A	0x3C	0x1A
Register 0 Low Byte	0x2B	0x4D	0x2B
Register 1 High Byte	0x3C	0x1A	0x3C
Register 1 Low Byte	0x4D	0x2B	0x4D

▶ **32 Bit-Wert 0x1A2B3C4D - Mode Big-Endian:**

Address	Example (Big-Endian)	Communication (Little-Endian)	Client-Side (Big-Endian)
Register 0 High Byte	0x1A	0x1A	0x1A
Register 0 Low Byte	0x2B	0x2B	0x2B
Register 1 High Byte	0x3C	0x3C	0x3C
Register 1 Low Byte	0x4D	0x4D	0x4D

### 13.1.5.2 Data Types

The Modbus implementation in the PQI-DA *smart* currently works with the following data types.

▶ **Unsigned Integer 32 Bit (uint32\_t)**

This data type stores unsigned integer values. According to the width of 32 bits, they are stored in two registers.

▶ **Float 32 Bit (float32)**

Float 32 bit floating point numbers are transmitted according to the IEEE 754 standard. These are stored in two registers. The interpretation of the values is described in detail at [https://de.wikipedia.org/wiki/IEEE\\_754](https://de.wikipedia.org/wiki/IEEE_754)

▶ **Float 64 Bit (double)**

Float 64 bit floating-point numbers are also transmitted according to the IEEE 754 standard. The width of 64 bits requires storage in four registers. The interpretation of these values is also described at [https://de.wikipedia.org/wiki/IEEE\\_754](https://de.wikipedia.org/wiki/IEEE_754).

► **Status (status\_t)**

The status value has a width of 32 bits. It is stored accordingly in two registers. The meaning of the individual bits is listed in the following table:

Bit-Number	Meaning
0	RVC, Voltage U1E
1	Dip, Voltage U1E
2	Swell, Voltage U1E
3	Interruption, Voltage U1E
4	Overload, Voltage U1E
5	RVC, Voltage U2E
6	Dip, Voltage U2E
7	Swell, Voltage U2E
8	Interruption, Voltage U2E
9	Overload, Voltage U2E
10	RVC, Voltage U3E
11	Dip, Voltage U3E
12	Swell, Voltage U3E
13	Interruption, Voltage U3E
14	Overload, Voltage U3E
15	RVC, Voltage U12
16	Dip, Voltage U12
17	Swell, Voltage U12
18	Interruption, Voltage U12
19	Overload, Voltage U12
20	RVC, Voltage U23
21	Dip, Voltage U23
22	Swell, Voltage U23
23	Interruption, Voltage U23
24	Overload, Voltage U23
25	RVC, Voltage U31
26	Dip, Voltage U31
27	Swell, Voltage U31

We take care of it.

---

28	Interruption, Voltage U31
29	Overload, Voltage U31
30	State Frequency Synchronization
31	free

▶ **Timestamp (uint32\_t)**

The 32-bit-wide time stamp is stored in two registers and must be interpreted as an integer value without sign. This is a UNIX time stamp, that is, the number of seconds since 1 January 1970, 00:00 hours (coordinated world time UTC), with no switching counts being counted.

Example: 1478787619 (0x58248223)

Value of time: 11. October 2016 14:20:19 (UTC)

Further information and an implementation example can be found at <https://de.wikipedia.org/wiki/Unixzeit>.

▶ **Sub seconds (tmFracSec\_t)**

The sub second value has a width of 32 bits and is accordingly stored in two registers. The data type is based on the time format, which is defined in IEEE C37.118. The meaning of the individual bits is listed in the following table:

Bit-Number	Meaning
0..23	Sub seconds in 100 ns increments
24..27	time quality indicator
28	Set as the announcement of a switch (1 min before)
29	Set, 24 hours after a switch
30	Add Leap Second (0) or remove (1)
31	Indicator winter time (0) or summer time (1)

## 13.2 IEC60870-104

Under Device Settings / SCADA protocol can be selected and activated IEC60870-104.

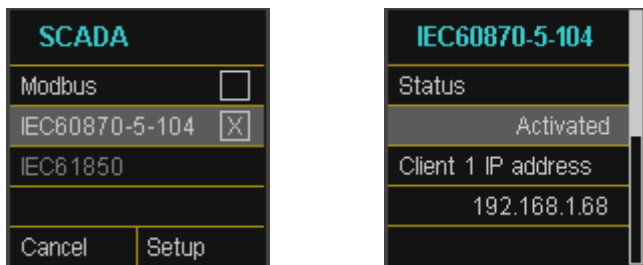

You can setup the device address and client address directly in the display menu.

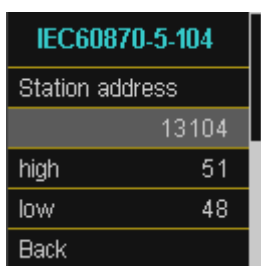

### 13.2.1 IEC60870-104 Data point

Please download the extensive IEC60870-104 data point list from our website [www.a-eberle.de](http://www.a-eberle.de)

**BA-SCADA PQI-DA smart**

### 13.2.2 IEC60870-104 Settings in WinPQ lite

WinPQ Interface (CCCC)	Parametername:	Wert:	Werkseinstellung:
device designation	ASDU-Adress (Decimal):	104	104
IP-Settings	Client IP address 1	192.120.50.10	0
▶ License Manager	Client IP address 2	0.0.0.0	0
Modbus	Client IP address 3	0.0.0.0	0
NTP	Client IP address 4	0.0.0.0	0
▶ Thresholds / Recording	Timeout connection establishment [s]	30	30
▶ Binary Recording	Timeout wait of ACK [s]	15	15
▲ SCADA-Manager	Send acknowledges after [s]	10	10
▲ IEC 60870-5-104	Idle Time-out for test frames [s]	20	20
Protocol Settings	K: Max. APDU without ACK [s]	12	12
▶ Datapoints IEC 104	W: latest ACK after receiving w APDU [s]	8	8
▶ PQ-Event counter			
▶ Binary Inputs			

IEC60870-104 settings can be modified via the WinPQ lite software.



▶ **ASDU Address:**

The ASDU address must be entered unstructured as a decimal number and has a value range of 0 - 256

Example: Address of the PQI-DA *smart* is "104" - which would correspond to "0" (high byte) - "104" (low byte) in a structured display.

▶ **Client IP – Addresses:**

It is possible to enter several client IP addresses (up to a maximum of 4) into the set-up of the interface, whereby only one client can actively access the PQI-DA *smart*. If the setting for all four client IP addresses is set to "0.0.0.0", any IEC60870-5-104 server could theoretically connect to the PQI-DA *smart*. **However, this is not recommended for safety reasons!**

**13.2.2.1 Settings of the data points for IEC60870-5-104**

The IEC 60870-5-104 interface has the following data types with the corresponding settings for each individual data point:

- TK 30: Single message with time stamp (UTC)(e.g. Binary inputs of the PQI-DA *smart*).
- TK 36: Measured value floating point with time stamp (UTC), e.g. Voltage current

Each data point can be activated or deactivated individually to reduce the amount of data. A special feature is that all TK 36 measurement values can be scaled via the scale Factor parameter



Since the set-up of the individual modules is can be individually transferred to the PQI-DA *smart*, for example, "Limit values / recording" or "IEC60870-5-104", it is recommended to save a template which can be used for all devices in your Grid!

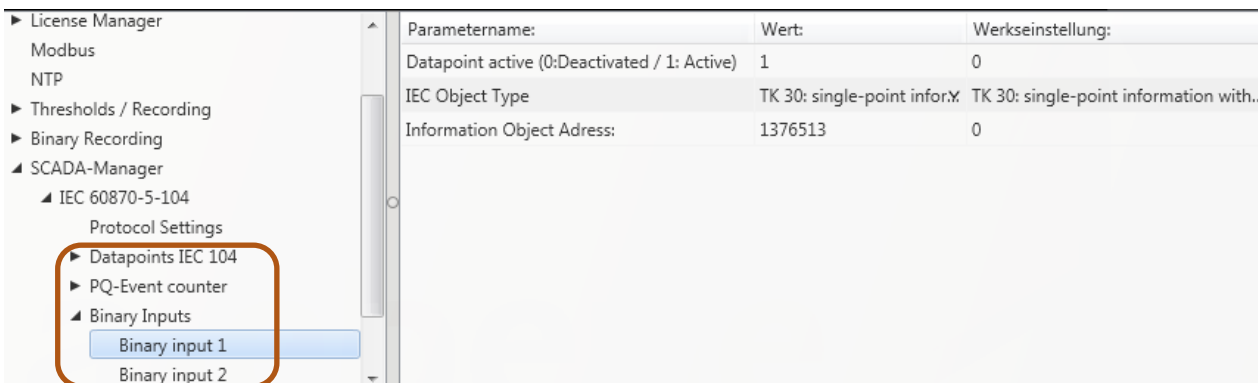

Parametername:	Wert:	Werkseinstellung:
Datapoint active (0:Deactivated / 1: Active)	1	0
IEC Object Type	TK 30: single-point infor.X	TK 30: single-point information with..
Information Object Adress:	1376513	0

## 13.3 IEC61850

The IEC61850 interface offers the possibility to connect 6 clients directly to the IEC61850 server (PQI-DA *smart*). The implementation of the IEC 61850 has been implemented on the basis of edition 2.1 of IEC 61850. The interface has the most important Power Quality parameters according to EN50160.

### 13.3.1 Display settings IEC61850

Under Device Settings / SCADA protocol IEC61850 can be selected and activated.



### 13.3.2 IEC61850 Data Points

Please download the comprehensive description and data point list from our website [www.a-eberle.de](http://www.a-eberle.de). The PQI-DA *smart* is supplied with two standard ICD files in the basic delivery with activated IEC61850 license. The profile (ICD file) matching the voltage level is selected automatically depending on the basic setting used (commissioning assistant).

- Low Voltage
- Medium Voltage / High Voltage

In the low voltage (EN50160 LV - Low Voltage), the harmonics and events conductor / earth are evaluated and correspondingly also made available in the IEC61850 interface. On the other hand, when selecting the EN50160 MV (medium voltage medium voltage) or HV (high voltage), the harmonics are provided as conductor / conductor sizes. The basic settings of the measuring instrument are described in detail in Chapter 6.1 and must be performed once.

### 13.3.3 IEC61850 settings in WinPQ lite

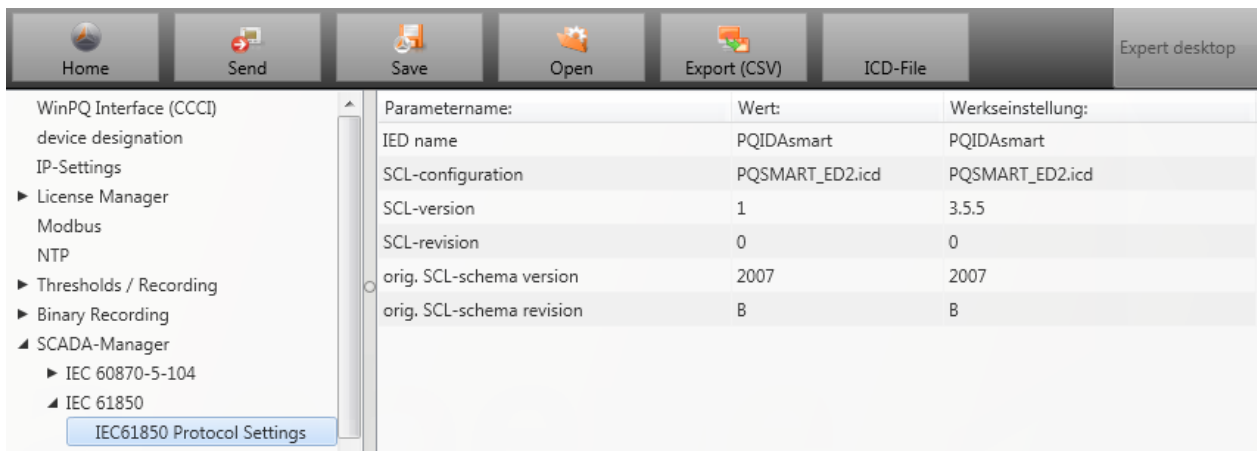

#### ► IED – name:

Each participant in an IEC61850 subnet requires a unique identifier. This can be adjusted using the "IED name" parameter. The IED name must meet the following standards (according to IEC61850):

- The IED name can consist of a maximum of eight letters or numbers
- Letter "Umlauts" or blanks are not allowed
- The first character must be a letter

If the IED name has been changed in the interface and sent with "Send" to the PQI-DA *smart*, the IED name is automatically accepted in the ICD file. The next readout of the set-up also takes the IED name into the ICD file and displays it.

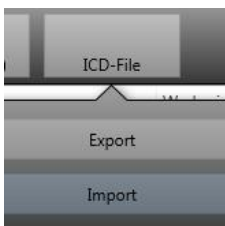

The icon "ICD File" can be used to download the ICD file in the device to be able to import it back into the SCADA system.

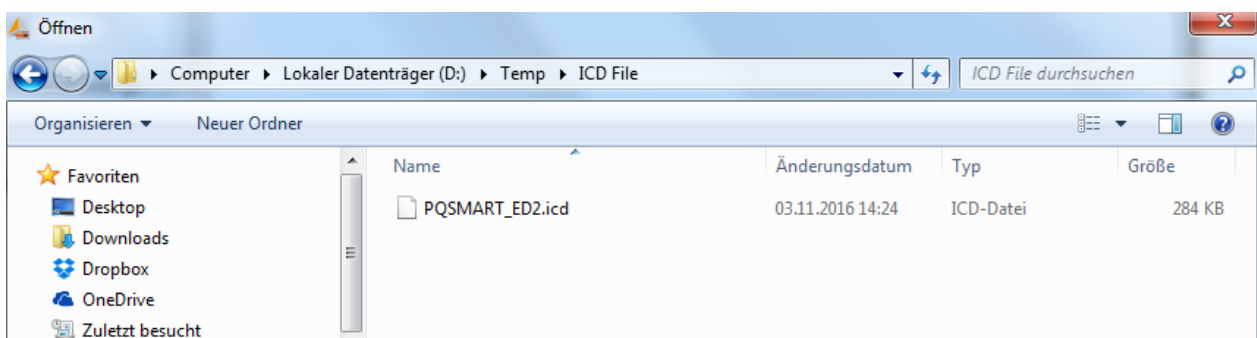

## 14. Measurement methods PQI-DA *smart*

The aggregation of the measurement values is carried out in accordance with the IEC61000-4-30 (2008) standard for class A devices.

▶ **RMS values of the voltages and currents, min. / max. values**

**U eff / I eff**

The interval value of the voltage or current is the mean of the RMS values of the length of the selected interval.

**U min / max; I min / max**

Per measurement period, the highest and lowest 10 ms voltage or current RMS value is saved in addition to the average.

▶ **Ripple control signal**

**U Ripple Control (200 ms)**

In the PQI-DA *smart* setup any interharmonic can be set. This is displayed as the 200 ms maximum value within a measurement interval.

▶ **Flicker levels P<sub>st</sub> / P<sub>lt</sub>**

The **Short term flicker levels P<sub>st</sub>** (10 min) and **Long term flicker levels P<sub>lt</sub>** (2 h) are calculated for the star and delta voltages. P<sub>st</sub> and P<sub>lt</sub> are defined in EN 61000-4-15: 2010.

The source for implementation recommendations is "EMV Messung von Spannungsschwankungen und Flickern mit dem IEC-Flickermeter" by W.Mombauer, VDE-Verlag, VDE-Schriftenreihe „Normen verständlich“, ISBN 3-8007-2525-8.

Formula for P<sub>lt</sub> calculation:

$$P_{lt} = \sqrt[3]{\frac{1}{12} \sum_{i=1}^{12} P_{st,i}^3}$$

The flicker meter can be parameterized in the device setup for the following grid configurations:

230V/50Hz; 230V/60Hz and 120V/50Hz; 120V/60Hz

► **THD – PWHD – K factor**

Total harmonic content, calculated using the following formulae in accordance with IEC61000-4-7.

Calculating the THD values of the voltages and signal sampling:

- H2 up to H40 (based on EN50160)
- H2 up to H50 (based on IEC61000-x-x)

- THD voltage:

$$THD_u = \frac{\sqrt{\sum_{v=2}^{40} U_v^2}}{U_1}$$

- THD current in %:

$$THD_i = \frac{\sqrt{\sum_{v=2}^{40} I_v^2}}{I_1}$$

- THD(A) current in Ampere:

$$THC = \sqrt{\sum_{n=2}^{40} I_n^2}$$

- PWHD - Partial Weighted Harmonic Distortion

The partial weighted THD calculates the 14th to 40th harmonics.

$$PWHD = \frac{\sqrt{\sum_{n=14}^{40} n \cdot C_n^2}}{C_1}$$

- PHC - Partial Odd Harmonic Current

The PHC is calculated from the odd current harmonics n = 21..39.

$$PHC = \sqrt{\sum_{n=21,23}^{39} C_n^2}$$

- K Factor

The values of the K-factors for phase currents are calculated from the corresponding RMS values  $C_n$  of the harmonics  $n = 1..40$ .

The K factor is a measure that indicates the ability of a transformer to withstand the current harmonics of a system.

Various transformer suppliers offer transformers with, for example, K factors  $K=4$ ,  $K=13$ ,  $K=20$  and  $K=30$ .

Transformers are heated more by harmonic currents than 50 Hz currents.

A transformer with a higher K-factor withstands this better and is not heated as much as a transformer with a lower K factor.

The device shows the K factor for the current. Only the K values that appear at maximum power are of interest. Just as with the THD of the currents in %, the value is not relevant at very low currents.

$$K = \frac{\sum_{n=1}^{40} (n \cdot C_n)^2}{\sum_{n=1}^{40} C_n^2}$$

► **Harmonics / Interharmonics**

The determination of the harmonics and interharmonics interval values displayed using the methods of the IEC61000-4-30 Class A standard based on 10/12 period values.

The PQI-DA *smart* recognizes for all voltage and current channels, respectively, the harmonics up to the 50th ordinal. To evaluate the interharmonics, harmonic subgroups are created. 50 subgroups are recorded for all current and voltage channels.

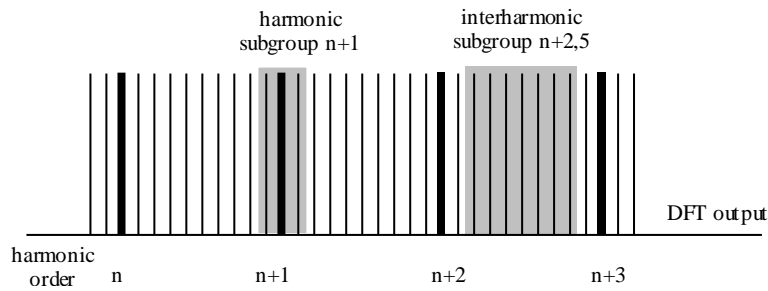

Example:

"IH1" is the first interharmonics group and evaluated the frequency range from 5 Hz to 45 Hz.

The harmonics for n = 0...50 are calculated.

Voltage harmonics (standardized, 10/12 periods):

$$U_{hn-10/12} = \frac{\sqrt{\sum_{k=n \cdot N-1}^{n \cdot N+1} U_{n-10/12}^2}}{U_{1-10/12}}$$

Current harmonics:

$$|I_{n-10/12}| = \sqrt{\frac{1}{2} \cdot \sum_{k=n \cdot N-1}^{n \cdot N+1} |C_k|^2}$$

► **Reactive power / Reactive energy**

In the setup of the device two variants of the power calculation are adjustable

- Simplified power calculation

Reactive power without unbalanced reactive power calculation:

$$Q = \sqrt{Q_V^2 + D^2} \quad Q_\Sigma = Q_{L1} + Q_{L2} + Q_{L3}$$

- Reactive power calculation according DIN40110 part 2

Reactive power calculation with unbalanced power:

$$Q_{L-10/12} = \text{Sgn}(\varphi_{L-10/12}) \cdot \sqrt{S_{L-10/12}^2 - P_{L-10/12}^2}$$

$$Q_{10/12} = \text{Sgn}(\varphi_{1-10/12}) \cdot \sqrt{S_{10/12}^2 - P_{10/12}^2}$$

- Reactive energy:

"Supply reactive energy" inductive reactive energies +EQ.

$$Q_S(n) = |Q_{L-10/12}(n)| \quad \text{für : } Q_{L-10/12}(n) \geq 0$$

$$Q_S(n) = 0 \quad \text{für : } Q_{L-10/12}(n) < 0$$

"Consumer reactive energy" capacitive reactive energies -EQ.

$$Q_S(n) = |Q_{L-10/12}(n)| \quad \text{für : } Q_{L-10/12}(n) < 0$$



▶ **Distortion reactive power - D**

The distortion-reactive power - also called harmonic oscillation power - describes a special form of reactive power caused by alternating and three-phase current through nonlinear loads such as rectifiers in power supplies. The harmonics of the current in combination with the mains voltage give reactive power components, which are referred to as distortion-blocking powers.

The distortion reactive powers are calculated from the voltages and the associated distortion currents calculated:

$$D = U \cdot \sqrt{\sum_{v=2}^{\infty} I_v^2}$$

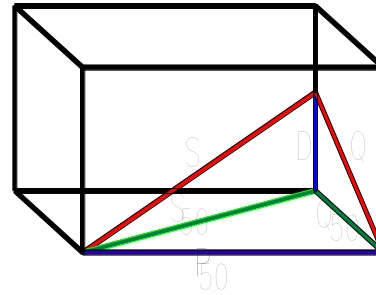

▶ **Power Factor PF**

In electrical engineering the power factor or active power factor is calculated as the ratio of real power P to the apparent power S. The power factor can be between 0 and 1.

The ration is expressed in the following equation:

Power Factor PF:  $\lambda = P / S$

▶ **Apparent Power - S**

In the setup of the device two variants of the power calculation are adjustable

- Simplified power calculation

$$S = \sqrt{P^2 + Q^2}$$

- Power calculation according DIN40110 part 2

Conductor apparent power 4-wire system:

$$S_L = U_{LNrms} \cdot I_{Lrms}$$

Conductor apparent power 3-wire system:

$$S_L = U_{L0rms} \cdot I_{Lrms}$$

Collective apparent power in accordance with DIN40110:

$$S_{\Sigma} = U_{\Sigma} \cdot I_{\Sigma} \quad U_{\Sigma} = \frac{1}{2} \cdot \sqrt{U_{12rms}^2 + U_{23rms}^2 + U_{31rms}^2 + U_{1Nrms}^2 + U_{2Nrms}^2 + U_{3Nrms}^2}$$

4-wire network:

We take care of it.

---

$$I_{\Sigma} = \sqrt{I_{1rms}^2 + I_{2rms}^2 + I_{3rms}^2 + I_{Nrms}^2}$$

3-wire network,  $I_1 + I_2 + I_3 \neq 0$  :

$$U_{\Sigma} = \frac{1}{2} \cdot \sqrt{U_{12rms}^2 + U_{23rms}^2 + U_{31rms}^2 + U_{1Erms}^2 + U_{2Erms}^2 + U_{3Erms}^2}$$

$$I_{\Sigma} = \sqrt{I_{1rms}^2 + I_{2rms}^2 + I_{3rms}^2 + I_{Erms}^2}$$

Geometric Fundamental Oscillations - Apparent Power:

$$\underline{S}_G = 3 \cdot [\underline{U}_{1\_PS} \cdot \underline{I}_{1\_PS}^* + \underline{U}_{1\_NS} \cdot \underline{I}_{1\_NS}^* + \underline{U}_{1\_ZS} \cdot \underline{I}_{1\_ZS}^*]$$

► **Active Power - P**

The sign of the active power corresponds with the flow direction of the fundamental oscillation active energy (+: supply, -: consumer).

The values of the conductor - active power are calculated from the samples of a synchronization cycle.

$$P_{L-10/12} = \frac{\sum_{n=1}^{2048} P_L(n)}{2048}$$

(200 rms values) with conductor index  $L = \{1, 2, 3, E\}$

The 10 min values are calculated as linear averages.

The collective effective power is defined for 4-wire systems as

$$P_{\Sigma} = P_1 + P_2 + P_3$$

The collective effective power is defined for 3-wire systems as

$$P_{\Sigma} = P_1 + P_2 + P_3 + P_E$$

Fundamental oscillation - active power (line):

$$P_G = \operatorname{Re}\{\underline{S}_G\}$$

$\underline{S}_G$  = Geometric fundamental oscillation apparent power

● **Symmetric Components**

The complex symmetrical components are calculated from the corresponding complex spectral components of the fundamental oscillations of the phase voltages and phase currents.

Phase voltage in a 4-wire system = Phase-to-Neutral voltage

Phase voltage in a 3-wire system = Phase-to-Ground voltage

We take care of it.

---

Positive sequence:

$$\underline{U}_{1\_PS} = \frac{1}{3} \cdot (\underline{U}_{1N-1} + \underline{a} \cdot \underline{U}_{2N-1} + \underline{a}^2 \cdot \underline{U}_{3N-1})$$

$$\underline{I}_{1\_PS} = \frac{1}{3} \cdot (\underline{I}_{1-1} + \underline{a} \cdot \underline{I}_{2-1} + \underline{a}^2 \cdot \underline{I}_{3-1})$$

Negative sequence:

$$\underline{U}_{1\_NS} = \frac{1}{3} \cdot (\underline{U}_{1N-1} + \underline{a}^2 \cdot \underline{U}_{2N-1} + \underline{a} \cdot \underline{U}_{3N-1})$$

$$\underline{I}_{1\_NS} = \frac{1}{3} \cdot (\underline{I}_{1N-1} + \underline{a}^2 \cdot \underline{I}_{2N-1} + \underline{a} \cdot \underline{I}_{3N-1})$$

Zero sequence:

$$\underline{U}_{1\_ZS} = \frac{1}{3} \cdot (\underline{U}_{1N-1} + \underline{U}_{2N-1} + \underline{U}_{3N-1})$$

$$\underline{I}_{1\_ZS} = \frac{1}{3} \cdot (\underline{I}_{1N-1} + \underline{I}_{2N-1} + \underline{I}_{3N-1})$$

▶ **UU Unbalance**

The unbalanced voltages are calculated from the corresponding values of the modal positive sequence, negative sequence and zero sequence components.

For the EN50160 (events) only the voltage unbalance  $u_u$  is relevant and corresponds to the ratio of the negative sequence to the positive sequence. The value is expressed in [%].

▶ **Frequency analysis 2 kHz to 9 kHz**

In the frequency analysis 2 kHz to 9 kHz respectively 200 Hz frequency bands are summarized.

The specification of each frequency is the center frequency in this 200 Hz band.

$$Y_b = \sqrt{\sum_{f=b-95 \text{ Hz}}^{b+100 \text{ Hz}} Y_{C_f}^2}$$

Example: Frequency band 8.9 kHz corresponds to all 5 Hz spectral lines from 8.805Hz to 9.000Hz

## 15. Service

This unit is maintenance-free for customers.

 <b>DANGER!</b>	<b>Risk of death due to electric shock!</b> <ul style="list-style-type: none"><li>➔ Do not open the unit.</li><li>➔ Maintenance of the device must only be carried out by A. Eberle.</li></ul>
---	--

- ➔ For service, contact A-Eberle.

### Service address:

A. Eberle GmbH & Co KG  
Frankenstraße 160  
D-90461 Nuremberg

### Cleaning:

Use a short, slightly damp, lint-free cloth. Make sure no liquid gets in the housing. Do not use window cleaner, household cleaners, sprays, solvent, cleaners that contain alcohol, ammonia solutions or abrasive cleaning agents. Please use only water for cleaning.

## 16. Disposal

A. Eberle GmbH & Co. assumes responsibility for the disposal of the device.

- ➔ Send all components to A. Eberle:

A. Eberle GmbH & Co. KG

Frankenstraße 160

D-90461 Nürnberg



## 17. Product Warranty

A. Eberle guarantees that this product and accessories will remain free of material and manufacturing defects for a period of three years from the date of purchase.

Warranty does not apply to damage caused by:

- Accidents
- Abuse
- Abnormal operating conditions.

To claim warranty, contact A. Eberle GmbH & Co KG in Nuremberg.



## A. Eberle GmbH & Co KG

Frankenstraße 160  
D-90461 Nuremberg  
Germany

Tel.: +49 (0) 911 / 62 81 08-0  
Fax: +49 (0) 911 / 62 81 08 96  
E-Mail: [info@a-eberle.de](mailto:info@a-eberle.de)

<http://www.a-eberle.de>

No. 584.0826

Version: 12/4/2019 6:28 PM