

SNT - BL SERİSİ / SERIES
MODEL: BL188

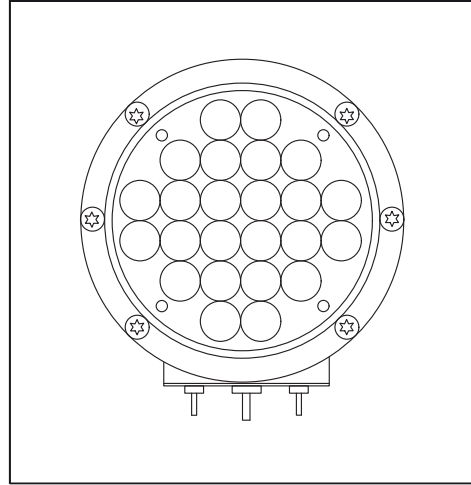

MUCCO
WARNING LAMPS

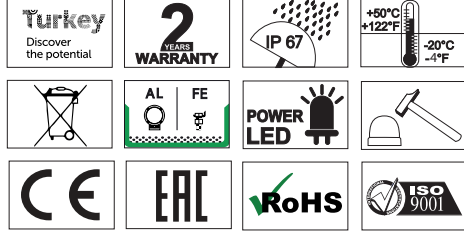

- Ürünün Bağlantısı En Az Elektrik Teknisyenleri Tarafından Yapılmalıdır.
- Ürün İç Ve Dış Mekanda Kullanılabilir.
- Ürünün İç Ve Dış Mekana Uyumluluğu Resimdeki Gibidir.
- Ürün Titreşim Ve Isının En Az Olduğu Yere Montaj Edilmelidir.
- Electrical connection must be carried out at least by trained electrical specialists.
- The product can be used indoors and outdoors.
- The interior and exterior compatibility of the product is like the picture.
- The product should be installed where the vibration and heat is minimum.

İÇ MEKAN / INDOOR

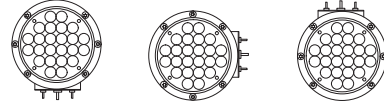

DIŞ MEKAN / OUTDOOR

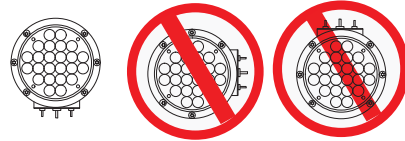

Model	Voltaj/Power Supply	Akım/Current(A)
SNT-BL188-1	10-48V/DC	0.80-6 A

* Değerler +/- %5 değişiklik gösterebilir.

* Values may vary by +/- %5.

Model	Ağırlık/Weight	Renk/Color
SNT-BL188	3500gr	(1) Kırmızı/Red



Epilepsi hastalığı olanların kullanmaması önerilir.
It is recommended that people with epilepsy should not use it.

SİNYALTEKNİK ELEKTRİK OTOMASYON İTH. İHR. SAN ve TİC. LTD. ŞTİ
İkithel O.S.B. Güyüm Sanatkarları San. Sit.
2. Ada C Blok No: 122 Başakşehir / İstanbul
Tel. +90 (212) 292 47 48 / Faks. +90 (212) 292 47 46
www.mucco.com.tr

MUCCO
WARNING LAMPS

1

ÖLÇÜLER / DIMENSIONS

229mm

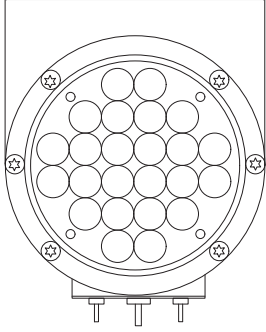

98 mm

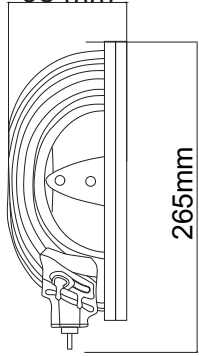

265mm

9mm

11mm

9mm

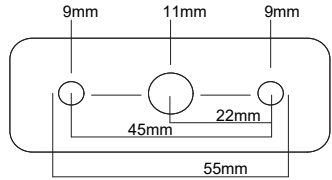

45mm

22mm

55mm

2

10-30V/DC

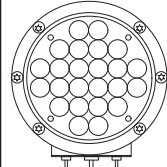

KIRMIZI / RED (+)
SİYAH / BLACK (-) BESLEME /
POWER SUPPLY

(2x0.86)